

AUGUST 1989 / \$2.95

NEW HAM RADIO

hp
Special
CQ WW DX Phone Contest
Record-breaking effort!

This month...

Vibration Induced Yagi Fatigue Failures

Versatile Transistor/Diode Tester

High Performance Duoband Yagi for 15 and 20 Meters

Plus, all your favorite monthly features!

ONLY ICOM COULD BUILD THIS MANY FEATURES INTO SUCH A TINY RADIO

ICOM'S AMAZING NEW MINI HANDHELD RIGS

ICOM's new "S Series" mini handhelds deliver top performance on the 144, 220 and 440MHz bands with super easy operation and a kaleidoscope of features. Built to fit your needs today, tomorrow, anywhere and anytime.



Wide Frequency Coverage. Plenty of overlap for scanning, monitoring, CAP and MARS use. IC-2SA/IC-2SAT: 138-174MHz Rx, 140-150MHz Tx. IC-3SAT: 220-225MHz Rx/Tx. IC-4SAT: 440-450MHz Sx/Tx.

Flexible Size And Power. The IC-2SA packs 2.5 watts with supplied BP-82. The IC-2SAT, 3SAT and 4SAT's internal battery packs 2 watts of output on high power. All models deliver five watts when powered via optional BP-85 battery pack or via top-mounted 13.8 volt socket. A small rig with a big punch!

48 Memories. Store your present frequencies and expand your future interests. Offset frequencies are independently programmed in memory channels 0-9. Memories 10-47 use offset frequency contents of the VFO. Also includes soft-sector memory masking. Use only the number of memories you need!

Band and Memory Scanning with programmable limits, memory skip

function, plus selectable power times while scanning. Additional features include:

Automatic Power

Shut-off. Built-in programmable timer automatically switches off transceiver when you forget.

Optional DTMF Paging Function. Silently monitors any selected frequency for your preprogrammed 3-digit DTMF-keyed calls, then beeps and displays calling station's code.

All ICOM's "S Series" handhelds are supported by an extensive line of optional battery packs, chargers, cases, speaker/mics and other accessories. See the exciting new ICOM mini-series handhelds at your authorized ICOM dealer today!

ICOM America, Inc., 2380-116th Ave. N.E., Bellevue, WA 98004
Customer Service Hotline (206) 454-7619
 3150 Premier Drive, Suite 126, Irving, TX 75063
 1777 Phoenix Parkway, Suite 201, Atlanta, GA 30349
 ICOM CANADA, A Division of ICOM America, Inc.,
 3071 - #5 Road, Unit 9, Richmond, B.C. V6X 2T4 Canada

All stated specifications are subject to change without notice or obligation. All ICOM radios significantly exceed FCC regulations limiting spurious emissions.

Four Power Selections

10 Memory DTMF Autodialer

24 Hour Clock With Timer

48 Memories

Easy Knob or Keypad Frequency Selection

Power Output

ICOM

First in Communications

**THE TRADITION LIVES ON...
TOMORROW'S TECHNOLOGY TODAY
LOOK TO EIMAC.**

1934

TODAY



3CX1200A7
1500 watts from
a single rugged tube



3CX800A7
1500 watts of high
performance from
a pair

For over fifty years Eimac has supported the amateur radio fraternity with the finest power tubes in the world. Started by radio amateurs, for radio amateurs, Eimac continues its tradition of dedication to amateur radio. The new 3CX800A7 and 3CX1200A7 are examples of this continual dedication to the development of tubes for amateur use.

The FCC now allows 1500 watts output power; these new tubes are tailored to the challenge. Enjoy the improving band conditions, the new WARC bands, and upgrade to 1500 watts output in your new linear.

varian  **eimac**

301 Industrial Way / San Carlos, CA 94070 / 415-592-1221

1678 South Pioneer Road / Salt Lake City, UT 84104 / 801-972-5000

KENWOOD

...pacesetter in Amateur Radio

3 Choices
70 W/45 W/25 W

Three Choices for 2m!

TM-2570A/2550A/2530A

Feature-packed 2m FM transceivers

The all-new "25-Series" gives you three RF power choices for 2m FM operation: 70 W, 45 W, and 25 W. Here's what you get:

- Telephone number memory and autodialer (up to 15 seven-digit phone numbers). **A Kenwood exclusive!**
- High performance GaAs FET front end receiver
- 23 channel memory stores offset, frequency, and subtone. Two pairs may be used for odd split operation
- 16-key DTMF pad with audible monitor
- Extended frequency coverage for MARS and CAP (142-149 MHz; 141-151 MHz modifiable)
- Center-stop tuning—a **Kenwood exclusive!**



- New 5-way adjustable mounting system
- Automatic repeater offset selection—**another Kenwood exclusive!**
- Direct keyboard frequency entry
- Front panel programmable 38-tone CTCSS encoder **includes** 97.4 Hz (optional)

- Big multi-color LCD and back-lit controls for excellent visibility

- The TM-3530A is a 25 watt version covering 220-225 MHz. The first full featured 220 MHz rig!



Introducing... Digital Channel Link

Compatible with Kenwood's DCS (Digital Code Squelch), the DCL system enables your rig to **automatically** QSY to an open channel. Now you can automatically switch over to a simplex channel after repeater contact! Here's how it works:

The DCL system searches for an open channel, remembers it, returns to the original frequency and transmits control information to another DCL-equipped station that switches **both** radios to the open channel. Micro-processor control assures fast and reliable operation. The whole process happens in an instant!

Actual size front panel



Optional Accessories

- **TU-7** 38-tone CTCSS encoder
- **MU-1** DCL modem unit
- **VS-1** voice synthesizer
- **PG-2N** extra DC cable
- **PG-3B** DC line noise filter
- **MB-10** extra mobile bracket
- **CD-10** call sign display
- **PS-430** DC power supply for TM-2550A/2530A/3530A

- **PS-50** DC power supply for TM-2570A
- **MC-60A/MC-80/MC-85** desk mics.
- **MC-48B** extra DTMF mic. with UP/DWN switch
- **MC-43S** UP/DWN mic.
- **MC-55** (8-pin) mobile mic. with time-out timer
- **SP-41** compact mobile speaker
- **SP-50B** mobile speaker
- **SWT-1** 2m antenna tuner

Complete service manuals are available for all Kenwood transceivers and most accessories. Specifications and prices are subject to change without notice or obligation. Specifications guaranteed on Amateur bands only.

KENWOOD

KENWOOD U.S.A. CORPORATION
COMMUNICATIONS & TEST EQUIPMENT GROUP
P.O. BOX 22745, 2201 E. Dominguez Street
Long Beach, CA 90801-5745
KENWOOD ELECTRONICS CANADA INC.
P.O. BOX 1075, 959 Gana Court
Mississauga, Ontario, Canada L4T 4C2

HAM RADIO

AUGUST 1989

Volume 22, Number 8

Publisher & Editor-in-Chief:
T.H. TENNEY, JR., W1NLB

EDITORIAL STAFF

Managing Editor:

Terry Northup, KA1STC

Technical Editor:

Marty Durham, NB1H

Consulting Editor:

Robert D. Wilson, WA1TKH

Associate Editors:

Tom McMullen, W1SL

Joseph J. Schroeder, W9JUV

Alfred Wilson, W6NIF

Production Editor: Susan Shorrock

Copy Editor: Peggy Tenney, KA1QDG

Editorial Assistant: Beth McCormack

Editorial Review Board:

Peter Bertini, K1ZJH

Forrest Gehrke, K2BT

Michael Gruchalla, P.E.

Bob Lewis, W2EBS

Mason Logan, K4MT

Vern Riportella, WA2LQQ

Ed Wetherhold, W3NQN

PUBLISHING STAFF

Assistant Publisher:

J. Craig Clark, Jr., N1ACH

Director of Advertising Sales:

Henry S. Gallup, N1GCF

Advertising Production Manager:

Dorothy Sargent, KA1ZK

Circulation Manager: Susan Shorrock

Circulation: Therese Bourgault

Traffic Manager: Phil Alix, N1FPX

Book Store: Maribeth Buchanan

On the Cover: Cushcraft HF and VHF antennas set against a late September sky at the QTH of WA1QFY.

See page 79 for the Ham Radio Magazine 1988-89 Sweepstakes Winners List.



W5JQE, page 30

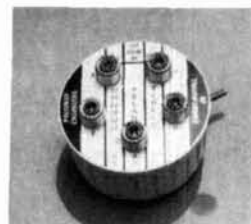

K4IPV, page 71

FEATURES

VIBRATION INDUCED YAGI FATIGUE FAILURES	9
<i>Dick Weber, K5IU</i>	
THE BATTLE OF THE BEAMS, PART 2	20
<i>D.V. Pritchard, G4GVO</i>	
The Weekender: VERSATILE TRANSISTOR/DIODE TESTER	30
<i>Jim Owens, W5JQE with G.D. Hanchett, W2YM</i>	
A HIGH PERFORMANCE DUOBAND YAGI FOR 15 AND 20 METERS	41
<i>David J. Rodman, M.D., KN2M</i>	
CQ WW DX PHONE CONTEST	47
<i>Mark Allen, WJ7X</i>	
Ham Radio Techniques: THE GAMMA MATCH: AN UPDATE	56
<i>Bill Orr, W6SAI</i>	
Practically Speaking: VERTICALLY POLARIZED HF ANTENNAS — PART 1	71
<i>Joseph J. Carr, K4IPV</i>	
Elmer's Notebook: VISUAL AIDS — LIQUID CRYSTAL DISPLAYS	81
<i>Tom McMullen, W1SL</i>	
The Weekender: AUTOMATIC ROTOR BRAKE DELAY	89
<i>Thomas V. Cefalo, Jr., WA1SPI</i>	

DEPARTMENTS

BACKSCATTER	4	HAM MART	92
COMMENTS	6	FLEA MARKET	94
HAM NOTEBOOK	66	ADVERTISER'S INDEX	98
PRODUCT REVIEW	84	READER SERVICE	98
NEW PRODUCTS	84,86,88		

HAM RADIO Magazine (ISSN 0148-5989) is published monthly by Communications Technology, Inc. Greenville, New Hampshire 03048-0498 Telephone: 603-878-1441. **Subscription Rates:** United States: one year, \$22.95; two years, \$38.95; three years, \$49.95. Canada and Mexico: one year, \$31.00; two years, \$55.00; three years, \$74.00. *All other countries:* one year, \$35.00 via surface mail only. All subscription orders payable in U.S. funds, via international postal money order or check drawn on U.S. bank. **International Subscription Agents:** page 70.

Microfilm copies are available from Buckmaster Publishing Mineral, Virginia 23117. Cassette tapes of selected articles from HAM RADIO are available to the blind and physically handicapped from Recorded Periodicals, 919 Walnut Street, Philadelphia, Pennsylvania 19107.

Copyright 1989 by Communications Technology, Inc. Title registered at U.S. Patent Office.

Second-class postage paid at Greenville, New Hampshire 03048-0498 and at additional mailing offices. *Send change of address to HAM RADIO, Greenville, New Hampshire 03048-0498.*

Backscatter

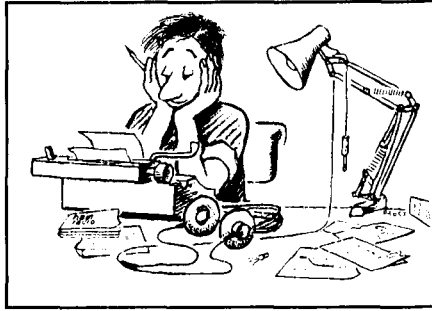

Ode to the Death of PRB-3

When PRB-3, the bill to allow special callsigns, was first announced I was overjoyed at the prospect of being able to get a coveted 1x2 callsign. No longer would I be asked if I belonged in the Extra part of the band. I could rightfully join my Extra class brethren as ?1??! Or so I thought.

I have never been overly attached to any of the three calls I've had. As a Novice, WN1IGG wasn't bad, but the phonetics were horrible — Weston's Number 1, I Go Goofy. Gratefully, I never went on the General bands with that one. When I finally passed the General in 1972, the FCC gave me WA1QWW. Now there was a call you could be proud of — WA1 Quarter Wave Whip. There was a nice ring to it on CW too. However, I was still searching for the "perfect" call. In 1978, it was time to move on and get my Advanced. Did I want a new call? Surely, I didn't want KA1sumthinorother. Group C calls sounded good, so I ended up with N1ACH.

When I got to HR in 1979, I felt duty bound to upgrade to Extra in keeping with our high tech image. It wouldn't look good for me to have *just* the Advanced. Sooooo, I got my Extra. But for some reason, I didn't put in for a callsign change. Maybe the 2x1's at the time didn't have enough pizazz to me.

That all changed when PRB-3 was announced. Whoopee! Now I can get the call I want. What would I get? I really liked the W1X series of calls. So, I went through the list to see what was available. Jim Kearman had let W1XZ go. That had a nice CW ring to it. So did a few others. But I felt I'd be taking someone else's property.

Then it hit me.

What better call to ask for than W1HR, Jim Fisk's old call. Now this call has pizazz! I felt it would be a fitting tribute to Jim's memory to carry on his call here at HR. Contests and DX circles would ring again with the familiar W1HR call. Could I get it? Would someone else beat me to the punch?

Getting ready for the FCC to implement PRB-3, I figured I would either FAX, FedX, or maybe even hand carry an application to the authorized "giver of callsigns." This was an opportunity I wasn't going to miss. I wanted W1HR so bad I could almost taste it.

At the Dallas ARRL 75th Anniversary Convention in June, the FCC announced that they had killed PRB-3. This dashed my hopes of ever getting that super special callsign I've been waiting for, once and for all. It also means that, unless there is a major change in the FCC, expired calls will never again be reissued. There are plenty of us who would be happy to reactivate those calls — but 'tis never to be.

Well one cannot be disappointed forever. Now I'm playing the waiting game for the next best thing — NX1?. If I time it right, mebbe I'll get NX1H. It's a roll of the dice at best, but it's all I have left to get that "special" callsign.

de NX1? dba N1ACH

KENWOOD

...pacesetter in Amateur Radio

DX-celence!

#1 Rated HF!

TS-940S Competition class HF transceiver

TS-940S—the standard of performance by which all other transceivers are judged. Pushing the state-of-the-art in HF transceiver design and construction, no one has been able to match the TS-940S in performance, value and reliability. The product reviews glow with superlatives, and the field-proven performance shows that the TS-940S is "The Number One Rated HF Transceiver!"

• 100% duty cycle transmitter.

Kenwood specifies transmit duty cycle **time**. The TS-940S is guaranteed to operate at full power output for periods **exceeding one hour**. (14.250 MHz, CW, 110 watts.) Perfect for RTTY, SSTV, and other long-duration modes.

• First with a full one-year limited warranty.

• **Extremely stable phase locked loop (PLL) VFO.** Reference frequency accuracy is measured in **parts per million!**

Optional accessories:

• AT-940 full range (160-10m) automatic antenna tuner • SP-940 external speaker with audio filtering • YG-455C-1 (500 Hz), YG-455CN-1 (250 Hz), YK-88C-1 (500 Hz) CW filters; YK-88A-1 (6 kHz) AM filter • VS-1 voice synthesizer • SO-1 temperature compensated

Complete service manuals are available for all Kenwood transceivers and most accessories. Specifications, features, and prices are subject to change without notice or obligation.

crystal oscillator • MC-43S UP/DOWN hand mic. • MC-60A, MC-80, MC-85 deluxe base station mics. • PC-1A phone patch • TL-922A linear amplifier • SM-220 station monitor • BS-8 pan display • SW-200A and SW-2000 SWR and power meters • IF-232C/IF-10B computer interface.

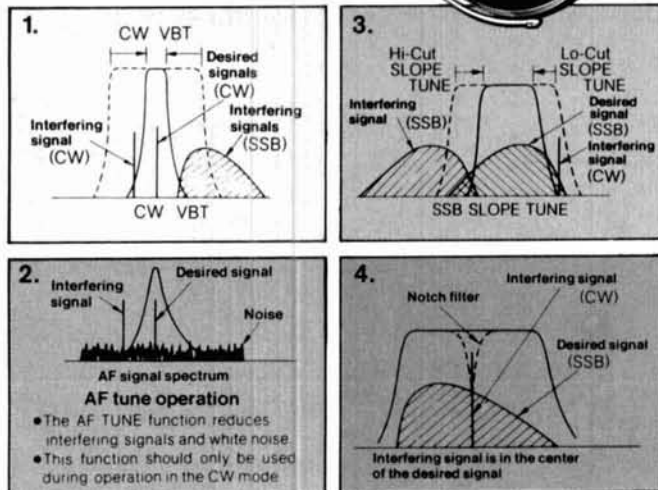

1) CW Variable Bandwidth Tuning. Vary the passband width continuously in the CW, FSK, and AM modes, without affecting the center frequency. This effectively minimizes QRM from nearby SSB and CW signals.

2) AF Tune. Enabled with the push of a button, this CW interference fighter inserts a tunable, three-pole active filter between the SSB/CW demodulator and the audio amplifier. During CW QSOs, this control can be used to reduce interfering signals and noise, and peaks audio frequency response for optimum CW performance.

3) SSB Slope Tuning. Operating in the LSB and USB modes, this front panel control allows independent, continuously variable adjustment of the high or low frequency slopes of the IF passband. The LCD sub display illustrates the filtering position.

4) IF Notch Filter. The tunable notch filter sharply attenuates interfering signals by as much as 40 dB. As shown here, the interfering signal is reduced, while the desired signal remains unaffected. The notch filter works in all modes except FM.

- **Complete all band, all mode transceiver with general coverage receiver.** Receiver covers 150 kHz-30 MHz. All modes built-in: AM, FM, CW, FSK, LSB, USB.
- **Superb, human engineered front panel layout for the DX-minded or contesting ham.** Large fluorescent tube main display with dimmer; direct keyboard input of frequency; flywheel type main tuning knob with optical encoder mechanism all combine to make the TS-940S a joy to operate.
- **One-touch frequency check (T-F SET) during split operations.**
- **Unique LCD sub display indicates VFO, graphic indication of VBT and SSB Slope tuning, and time.**
- **Simple one step mode changing with CW announcement.**
- **Other vital operating functions.** Selectable semi or full break-in CW (QSK), RIT/XIT, all mode squelch, RF attenuator, filter select switch, selectable AGC, CW variable pitch control, speech processor, and RF power output control, programmable band scan or 40 channel memory scan.

KENWOOD

KENWOOD U.S.A. CORPORATION
2201E, Dominguez St., Long Beach, CA 90810
P.O. Box 22745, Long Beach, CA 90801-5745

Comments

Learning CW a "plus" for all hams

Dear HR

Concerning the no-code proposal: I feel that some opposition should be laid out to avoid dangers to the Amateur Radio service. Some of the problems created by having no code as an enticement into the Amateur Radio ranks are as follows:

Having a lack of CW knowledge in a state of emergency can prove disastrous. The no-code proposal, if passed, will let flocks of hams into the VHF and UHF ranks. This may be nice for a while, but then it will be proposed for the HF ranks. Pretty soon, CW itself will be the "obsolete language" of ham radio.

Eliminating the code test makes a mockery out of all the hams who have studied so hard to join the elite ranks of Amateur Radio in the first place. New young hams? Why is the code so hard for them to learn? It seems to me that the complaints stem from the older hams who just can't grasp the language. I was licensed all the way to Extra by the time I was 13 years old.

Pointing to CW as a learning block for all of the new hams is absolutely wrong. Come on! How about all of the new computer programmers who want to get onto radio? Anyone who can program those machines of splendor and strength should be able to pass a CW test.

The problem of slowing Amateur Radio growth stems from the older, experienced hams not getting the new ranks involved. Walking down a city street, probably only 5 in 20 people know what ham radio really is! Let's get on our feet and wave the Amateur Radio banner.

Instead of standing around arguing whether we should pass a CW test or not, let's pass out the code tapes and get rolling! I have five new friends who are getting their licenses soon, CW capable of course. See you on the bands, CW no doubt!

**John Muhr, KTOF,
Littleton, Colorado**



Preservation — our right

Dear HR

The late great Radio Amateur, Col. Clair Foster, W6HM (who personally paid for the first state-of-the-art ARRL headquarters station, W1MK), used to stress an argument that strongly calls for retention and expansion of our ham bands:

"They are like our national parks," he said. "They provide for the exercise of a valuable national talent (see Sec. 1 of the FCC rules). We don't log our national parks, do we? Taking ham frequencies for commercial use should not be permitted any more than the despoiling of our national parks for profit."

**Louis R. Huber, W7UU,
Seattle, Washington**

A tradeoff

Dear HR

I just read Bill Orr's "What is the correct radial length?" portion of April's Ham Radio Techniques. Bill surmised that radial length as compared to wavelength may not be critical in the HF spectrum. I have to agree, since I often wondered just exactly what people mean when they refer to "resonant radials." Are there things? I didn't think that radial's exhibit any reactive characteristics which are necessary to qualify as a tuned circuit. Isn't the primary objective to reduce ground resistance as much as possible in order to capture the greatest amount of displacement currents?

When reading many of the antenna books one might assume that if you're

constructing a multiband vertical for HF you should cut radials at different lengths for the different bands. Not so, bury as many as you can and as long as your pocket book can afford. The impact on SWR should be dealt with *after* obtaining the highest efficiency possible. New hams would be well advised that a higher SWR due to an increase in length or number of radials is not indicative of a poor system. It simply means that since you have decreased ground resistance which results in increased efficiency, you must change *something* in the system that will "rematch" the transmission line and antenna.

**Patrick Bouldin, KM5L,
Lancaster, Texas**

Better management of HF bands needed

Dear HR

Enough is enough. I've been involved with ham radio for about 25 years. I spend all my radio time on the HF bands, especially 20 and 10. The atrocities that take place nowadays are demoralizing and the list is long: people tuning up on QSOs, running a carrier on DX, contacts on contacts as if 500 kc wasn't close enough, calling CQ without checking for a clear frequency first, deliberate malicious interference, not giving consideration to phone nets, RTTY on phone QSOs, etc. Even on CW some of the same problems exist.

It used to be the first time you did something wrong you received a letter from the FCC. Nowadays, nobody worries because they know that nothing is going to happen to them. After recent calls to my local FCC office and section manager I find this to be unfortunately true. I think it's time to admit that the Amateur community is not capable of handling the job of self-policing. If it comes down to the point where the FCC can't do the job because of money, then we're doomed to be no better off than the Cbers.

**Glenn Durant, KB0BHN,
Firestone, Colorado**

KENWOOD

...pacesetter in Amateur Radio

TH-55AT
1200 MHz
Here Now!

Compact Breakthrough!



TH-25AT/45AT

New Pocket Portable Transceivers

The all-new TH-25 Series of pocket transceivers is here! Wide-band frequency coverage, LCD display, 5 watt option, plus...

- Frequency coverage: **TH-25AT:** 141-163 MHz (Rx); 144-148 MHz (Tx). (Modifiable for MARS/CAP. Permits required.)
TH-45AT: 438-450 MHz.
- Automatic Power Control (APC) circuit for reliable RF output and final protection.
- 14 memories; two for **any** "odd split" (5 kHz steps).
- Automatic offset selection (TH-25AT).
- 5 Watts from 12 VDC or PB-8 battery pack.
- Large multi-function LCD display.
- Rotary dial selects memory, frequency, CTCSS and scan direction.
- T-ALERT for quiet monitoring. Tone Alert beeps when squelch is opened.
- Band scan and memory scan.
- Automatic "power off" circuit.
- Water resistant.
- CTCSS encoder / decoder optional (TSU-6).
- **Supplied accessories:** StubbyDuk, PB-6 battery pack for 2.5 watts output, wall charger, belt hook, wrist strap, water resistant dust caps.



Optional accessories:

- PB-5 7.2 V, 200 mAh NiCd pack for 2.5 W output • PB-6 7.2 V, 600 mAh NiCd pack • PB-7 7.2 V, 1100 mAh NiCd pack
- PB-8 12 V, 600 mAh NiCd for 5 W output • PB-9 7.2 V, 600 mAh NiCd with built-in charger • BC-10 Compact charger
- BC-11 Rapid charger • BT-6 AAA battery case • DC-1/PG-2V DC adapter • HMC-2 Headset with VOX and PTT • SC-14, 15, 16 Soft cases • SMC-30/31 Speaker mics • TSU-6 CTCSS decode unit • WR-1 Water resistant bag

KENWOOD

KENWOOD U.S.A. CORPORATION
2201E. Dominguez St., Long Beach, CA 90810
P.O. Box 22745, Long Beach, CA 90801-5745

Complete service manuals are available for all Kenwood transceivers and most accessories. Specifications, features, and prices are subject to change without notice or obligation.

MFJ TUNERS

Here is the finest 3 KW PEP Tuner money can buy with roller inductor, dummy load, new peak reading meter, antenna switch, balun and more ...

The MFJ-989C is not for everyone. However, if you do make the investment you get the finest 3 KW PEP tuner money can buy - one that will give you a lifetime of use, one that takes the fear out of high power operation and one that lets you get your SWR down to absolute minimum.

The MFJ-989C is a compact 3 KW PEP roller inductor tuner with a new peak reading Cross-Needle SWR/Wattmeter. The roller inductor lets you get your SWR down to absolute minimum.

With three continuously variable components - two massive 6 KV capacitors and a high inductance roller inductor - you get precise control over



MFJ-989C

\$349⁹⁵

SWR and the widest matching range possible from 1.8-30 MHz.

You get a new lighted peak and average reading Cross-Needle SWR/Wattmeter with a new more accurate directional coupler.

You get a giant two core balun wound with teflon wire for balanced lines and a 6-position antenna switch with extra heavy switch contacts.

Its compact 10³/₄x4¹/₂x15 inch cabinet fits right into your station.

You get a 50 ohm 300 watt dummy load for tuning your exciter, a tilt stand for easy viewing and a 3-digit turns counter plus a spinner knob for exact inductance control. Add \$10 s/h.

2-knob Differential-T™ Tuner



MFJ-986 The new MFJ-986 Differential-T™ 3 KW PEP 2-knob Tuner has a differential capacitor to make tuning foolproof and easier than ever. It ends constant retuning with broadband coverage and gives you minimum SWR at only one best setting. Covers 1.8-30 MHz.

The roller inductor lets you tune your SWR down to absolute minimum. A 3-digits turns counter lets you quickly return to your favorite frequency.

You get MFJ's new peak and average reading Cross-Needle SWR/Wattmeter with a new directional coupler for more accurate readings over a wider frequency range. It reads forward/reflected power in 200/50 and 2000/500 watt ranges. Meter lamp is front panel switched and requires MFJ-1312, \$9.95.

A new current balun for balanced lines reduces feedline radiation and forces equal currents into antenna halves that are not perfectly balanced for a more concentrated, stronger signal. Add \$10.00 s/h.

MFJ's Fastest Selling Tuner



MFJ-941D 300 watt PEP antenna tuner. Why? **\$109⁹⁵** Because it has more features than tuners costing much more and it matches everything continuously from 1.8-30 MHz.

It matches dipoles, vees, verticals, mobile whips, random wires, balanced and coax lines.

SWR/Wattmeter reads forward/reflected power in 30 and 300 watt ranges. Antenna switch selects 2 coax lines, direct or through tuner, random wire, balanced line or tuner bypass. Efficient airwound inductor gives lower losses and more watts out. Has 4:1 balun, 1000 V capacitors, 10x3x7 inches.

MFJ's Random Wire Tuner

MFJ-16010 **\$39⁹⁵**

You can operate all bands anywhere with any transceiver when you let the MFJ-16010 turn any random wire into a transmitting antenna. Great for apartment, motel, camping operation. Install a wire anywhere! Tunes 1.8-30 MHz. 200 watts PEP. Ultra small 2x3x4 in.



MFJ's Best 300 Watt Tuner



MFJ-949C The MFJ-949C gives you more precise matches than any tuner that uses two tapped inductors. Why? **\$149⁹⁵**

Because you get two continuously variable capacitors that give you infinitely more positions than the limited number on switched coils.

This gives you the precise control you need to get your SWR down to a minimum. After all, isn't that why you need a tuner? Covers 1.8-30 MHz.

You also get MFJ's lighted 2-color Cross-Needle SWR/Wattmeter, 6-position antenna switch, 50 ohm 300 watt dummy load and a built-in balun - all in a compact 10x3x7 inch cabinet that fits right into your station. Meter light requires MFJ-1312, \$9.95.

With MFJ's best 300 watt PEP tuner you get an MFJ tuner that has earned a reputation for being able to match just about anything - one that is highly perfected and has years of proven reliability.

MFJ's Mobile Tuner



MFJ-945C

\$89⁹⁵

Don't leave home without this mobile

tuner! Have an uninterrupted trip as the MFJ-945C extends your antenna bandwidth and eliminates the need to stop, go out and adjust your mobile whip.

You can operate anywhere in a band and get low SWR. You'll get maximum power out of your solid state or tube rig and it'll run cooler and last longer.

Small 8x2x6 inches uses little room. SWR/Wattmeter and convenient placement of controls make tuning fast and easy while in motion. 300 watts PEP output, efficient airwound inductor, 1000 volt capacitors. Mobile mount, MFJ-20, \$3.00.

144/220 MHz VHF Tuners

MFJ-921 **\$69⁹⁵**

MFJ's new VHF tuners cover both 2 Meters and the 220 MHz bands. They handle 300 watts PEP and match a wide range of impedances for coax fed antennas. SWR/Wattmeter. 8x2¹/₂x3 in. MFJ-920, \$49.95. No meter. 4¹/₂x2¹/₂x3 inches.



MFJ

MFJ ENTERPRISES, INC.

Box 494, Miss. State, MS 39762
(601) 323-5869; TELEX: 53 4590 MFJSTKV

MFJ's Artificial RF Ground

\$79⁹⁵ MFJ-931



You can create an artificial RF ground and eliminate

RF "bites", feedback, TVI and RFI when you let the MFJ-931 resonate a random length of wire and turn it into a tuned counterpoise. The MFJ-931 also lets you electrically place a far away RF ground directly at your rig -- no matter how far away it is -- by tuning out the reactance of your ground connection wire.

Barefoot/1.5 KW Linear Tuner



MFJ-962C

\$229⁹⁵

For a few extra dollars, the MFJ-962C lets you use your barefoot rig now and have the capacity to add a 1.5 KW PEP linear amplifier later. Covers 1.8-30 MHz. You get two husky continuously variable capacitors for maximum power and minimum SWR. And lots of inductance gives you a wide matching range.

You get MFJ's new peak and average reading Cross-Needle SWR/Wattmeter with a new directional coupler for more accurate readings over a wider frequency range. It reads forward/reflected power in 200/50 and 2000/500 watt ranges. Meter lamp is front panel switched and requires MFJ-1312, \$9.95.

Has 6-position antenna switch and a teflon wound balun with ceramic feedthru insulators for balanced lines. 10³/₄x4¹/₂x14 7/8 inches. Add \$10.00 s/h.

MFJ's smallest Versa Tuner

MFJ-901B

\$59⁹⁵

The MFJ-901B is our smallest -- 5x2x6 inches -- (and most affordable) 200 watt PEP tuner -- when both space and your budget is limited. Good for matching solid state rigs to linears.

It matches whips, dipoles, vees, random wires, verticals, beams, balanced and coax lines from 1.8-30 MHz. Efficient airwound inductor. 4:1 balun.

FOR YOUR NEAREST DEALER OR TO ORDER

800-647-1800

• 1 year unconditional guarantee • 30 day money back guarantee (less s/h) on orders from MFJ • Free catalog • Add \$5.00 s/h (except as noted)

VIBRATION INDUCED YAGI FATIGUE FAILURES

By Dick Weber, K5IU, Box 44, Prosper, Texas 75078

Yagi element failure can be attributed to two basic causes. The first type of failure occurs when an element isn't strong enough to hold up when forces are applied. These forces may be caused by a thick layer of ice, high winds, or a combination of the two. Under the stress of these forces, the element either bends or breaks off, with signs of bending in the area of the break.

The second type of failure takes place after an element has been fluttering, or vibrating, in a relatively low wind stream. The break caused by this kind of failure is quite different. There's no sign of bending in the area of the break; it's a jagged line through the element. In addition to element fluttering, boom fluttering (although not as common) can lead to the same failure.

Because there's no sign of bending you'll know that the stress levels in the material are relatively low, yet failure occurs. What causes an element to flutter in the wind? What causes a break although the stress levels are well below those required to bend the tube? And what methods will minimize or eliminate this type of failure?

Understanding flutter

Two key areas that must be explored to understand flutter are the vibratory aspects of the element and the forces that set it in motion.

An element has mechanical resonant frequencies which can be excited. **Figure 1** shows four modes of element vibration and the shape the element takes during oscillation in each mode. These resonant modes happen at discrete, not harmonically related, resonant frequencies. The element has stiffness and mass — the necessary ingredients for resonance. The modes are different situations where the ingredients blend properly to yield resonance. There's a separate resonant frequency with each mode. This means the element can have several resonant frequencies. Use the equations shown with each mode in **Figure 1** to calculate the resonant frequency for that mode. **Equations 1 through 4** are for an element made of one tubing size! Finding resonant frequencies for elements constructed of telescoped sections is best handled by computer finite element structural analysis programs. You can make approximations with the equations shown by selecting a tube diameter the same as the second or third smallest in the element. **Table 1** shows the resonant frequencies for vari-

FIGURE 1

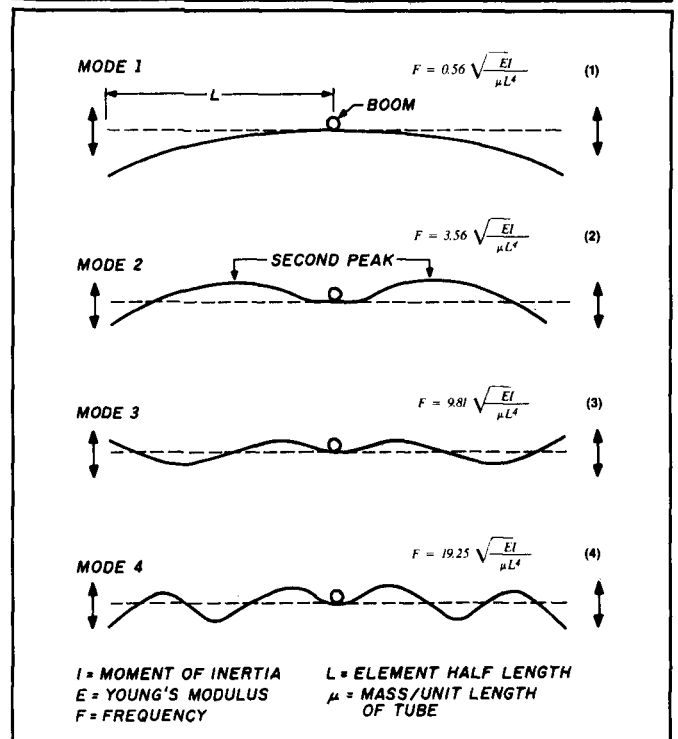

The four possible modes of element oscillation.

ous lengths and sizes of tubing for the first four modes. (Telescoped elements will have resonant frequencies in the ranges shown in **Table 1**.)

The mechanical resonances are lightly damped. Their behavior is exactly like high Q resonant electrical circuits. As a result, small exciting forces cause large displacement oscillations. For this to happen, and for flutter to be established, there has to be an exciting force at or very near one of the mode resonant frequencies. In addition, the excitation must be maintained to sustain the element oscillation. Where does this excitation come from? How can a mild wind stream provide a vibratory input to initiate and maintain an element oscillation?

Wind excitation

Several things can occur when air flows over a round tube. At low wind speeds nothing happens. The air flows around the tube creating no disturbances of any kind. At higher wind speeds, the air can't cling to the back side of the tube. This creates vortices, or swirls of air. At first the vortices form in pairs coming from both edges of the tube.

TABLE 1

Resonant frequencies of the first four modes for various element configurations.

Element Tube Diameter (inches)	Half Length (inches)	Wall Thickness (inches)	Mode 1 (Hz)	Mode 2 (Hz)	Mode 3 (Hz)	Mode 4 (Hz)
0.500	100	0.058	1.2	7.9	21.8	42.6
0.625	100	0.058	1.6	10.0	27.8	54.5
0.750	100	0.058	1.9	12.3	33.8	66.4
0.875	100	0.058	2.3	14.5	39.9	78.3
0.500	135	0.058	0.7	4.3	11.9	23.4
0.625	135	0.058	0.9	5.5	15.2	29.3
0.750	135	0.058	1.1	6.7	18.6	36.4
0.875	135	0.058	1.2	7.9	21.9	42.9
1.000	135	0.058	1.4	9.2	25.3	49.5
0.625	200	0.058	0.4	2.5	6.9	13.6
0.625	200	0.116	0.36	2.3	6.4	12.5
0.750	200	0.058	0.5	3.1	8.5	16.6
0.750	200	0.116	0.45	2.9	7.9	15.4
0.875	200	0.058	0.6	3.6	10.0	19.6
0.875	200	0.116	0.5	3.4	9.4	18.3
1.000	200	0.058	0.7	4.2	11.5	22.5
1.000	200	0.116	0.6	3.9	10.6	21.3
1.125	200	0.058	0.75	4.7	13.0	25.5
1.125	200	0.116	0.7	4.5	12.4	24.3
1.250	200	0.058	0.83	5.3	14.5	28.2
1.250	200	0.116	0.79	5.0	13.9	27.2

FIGURE 2

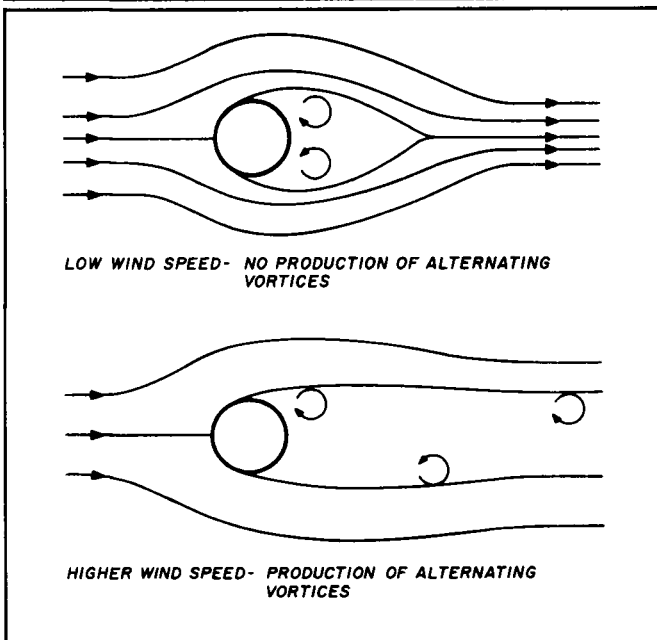

Diagram showing the cause of oscillation due to the creation of alternating vortices.

As the wind speed increases, the vortices leave first one edge of the tube and then the other. The formation of the vortices alternates back and forth between the two edges. The result is an oscillatory pressure loading on the tube. When the frequency of vortex formation is the same as the resonant frequency of one of the element vibratory modes, the element begins to flutter. **Figure 2** shows the various stages of vortex shedding.

As the wind stream velocity increases, the frequency of vortex formation accelerates. When the frequency of the vortex shedding builds up sufficiently, the element stops vibrating because the excitation is not at, or near, a mode resonant frequency. Similarly, as the wind speed decreases, either vortices cannot be shed or the frequency of shedding drops below a mode resonant frequency. The result is the same: the element stops vibrating.

As the wind speed continues to increase, vortices continue to be produced, but with greatly diminished amplitude. No effective excitation is produced above a certain air velocity. The result is a range of possible frequencies that can excite an element. The element will flutter only if the wind sheds vortices from the tube at or near an element mode resonant frequency.

Use **Equation 5** to find the shedding frequency.² The term Nr is an important parameter; it determines the interplay of the tube size, air velocity, air density, and air viscosity. Shedding occurs when Nr is in the range of 60 to 10,000.³ Although shedding can occur over this wide range of Nr , other conditions may not be suitable for the initiation of element flutter.

$$f = 3.52 \cdot \frac{V}{D} \cdot \left[1 - \frac{20}{Nr} \right] \tag{5}$$

$$Nr = 774 \cdot V \cdot D \tag{6}$$

f = frequency of vortex shedding (Hz)

V = wind velocity (mile/hour)

D = tube diameter (inches)

Nr = Reynolds number (dimensionless) (air parameters factored into coefficient)

TABLE 2

Wind and frequency ranges for vortex shedding		
Tube size (inches)	Wind speed range (mph)	Frequency range (Hz)
0.250	0.30—52	2.8—730
0.375	0.20—34	1.4—318
0.500	0.16—26	0.8—182
0.625	0.13—21	0.5—118
0.750	0.10—17	0.3—80
0.875	0.09—15	0.2—60
1.000	0.08—13	<0.2—46
1.125	0.07—11	<0.1—34
1.250	0.06—10	<1.1—28

Table 2 shows the wind speed ranges for tube sizes having the correct Nr range. There's no reason to consider wind speeds out of these ranges for a particular tube size when using Equation 5. This means that for the tubing sizes used in a Yagi element there's an upper and lower boundary to the frequencies which may start fluttering. If an element is made of several diameters of tubing, the upper and lower shedding frequencies are determined by the smallest and largest diameter tubes, respectively. Table 2 also lists the range of shedding frequencies for each tube size. The possible frequency range is, theoretically, extremely wide.

The extremely low wind velocities within the range of Nr offer little danger. There's generally insufficient energy in the wind stream to cause pressure loadings of any appreciable magnitude on the tube. In addition, at higher wind speeds the flow is so turbulent that the vortices don't all shed from one side of the tube and then the other. They come off the tube at about the same frequency, but not in an orderly fashion.³

What then is the proper range of wind speeds which can cause fluttering? My own experience and observations have been of wind speeds less than 35 mph. This still leaves a wide range of frequencies that can be generated by vortex shedding. I've seen many elements vibrate in mode 2 and several vibrate in mode 3. I've also seen elements vibrate at a fixed frequency even though the wind speed wasn't constant. This indicates that a broad band of frequencies can be generated by vortex shedding from the same element, not only because of multiple element diameters, but also because the shedding frequency isn't inherently stable. I have never seen mode 1. Either there's insufficient energy in the wind stream at these wind speeds, or the vortices detach themselves when the element begins to vibrate, and the element shuts itself down.

The possible range of exciting frequencies in Table 2 shows that these frequencies are in the range of the resonant frequencies of the various tube configurations in Table 1. Don't consider the lower frequencies in Table 2 too seriously; there's a very small level of energy in the corresponding wind streams. It also appears that elements should begin vibrating in any wind stream. In reality, this doesn't happen. Even in view of the anomalies, you can gain insight into the vibratory behavior of a fluttering element.

Element fatigue failure

An element that breaks as a result of sustained fluttering fails by a different mechanism than if it bends due to a very

high force. When an element bends or breaks off because of a very high wind or ice load, the yield stress of the material has been exceeded. An element can be deformed by a force below the yield stress, but when the force is removed the element will return to its original starting point. For example, if you pull a Yagi element with your hand, it will deflect several inches. When you let go, the element will return to its original shape. If you pull on the element enough to give it a permanent bend, you have stressed the material above its yield stress. Therefore, exceeding the yield stress results in a permanent bend. If the yield stress is greatly exceeded, the element will first bend and then break. An element which fails due to fluttering breaks for a different reason.

When aluminum is flexed at levels below the yield stress, no permanent bend results but damage accumulates. If the flexing is repeated enough times, the accumulated damage in the material results in a fatigue failure. The higher the load, the less load applications are needed to give a fatigue failure. The lower the load, the more cycles of application are needed to create the same accumulated damage. When an element flutters long enough, the accumulated damage in the material gets to the level where the element suffers fatigue failure.⁴ However, there's no sign of a bend or evidence indicating the material has exceeded its yield stress near the break.

Minimizing element failure

There are several things that can be done if an element flutters. You can attempt a modification to the element to limit the amplitude of the stress during fluttering. Try increasing damping in the element to extend its life. This will lower the Q of the mechanical resonance, which means that the tube will take many more load cycles to generate a failure. I've heard of people filling the inside of elements with foam intended for sealing and insulating cracks and holes in buildings. This method may work. But if you attempt this, take two identical elements and foam only one. After the foam has cured, shake both of them in your hand to see if there is an appreciable difference in how the element vibrates when excited. Shake the element to set up a mode 2 oscillation (see Figure 1). Once you have oscillation, stop moving your hand and see how long it takes for the element to stop shaking. If the foamed one damps out sooner, you may have a working solution.

You might also modify the shape of the element so that orderly vortices can't be shed. To do so, wrap a wire in a helix around the element.⁵ The wire diameter should be

TABLE 3

Resonant frequencies of the first four modes with 1/2" rope for various element configurations

Tube diameter (inches)	Element half length (inches)	Wall thickness (inches)	Mode 1 (Hz)	Mode 2 (Hz)	Mode 3 (Hz)	Mode 4 (Hz)
0.500	100	0.058	1.15	7.3	20.1	39.5
0.625	100	0.058	1.5	9.5	26.1	51.3
0.750	100	0.058	1.8	11.7	32.2	63.1
0.875	100	0.058	2.2	13.9	38.2	74.9
0.500	135	0.058	0.6	4.0	11.0	21.6
0.625	135	0.058	0.8	5.2	14.3	28.1
0.750	135	0.058	1.0	6.4	17.6	34.6
0.875	135	0.058	1.19	7.6	20.9	41.1
1.000	135	0.058	1.38	8.8	24.3	47.7
0.625	200	0.058	0.37	2.4	6.5	12.8
0.625	200	0.116	0.35	2.2	6.1	12.0
0.750	200	0.058	0.45	2.9	8.0	15.7
0.750	200	0.116	0.43	2.8	7.6	14.9
0.875	200	0.058	0.5	3.5	9.6	18.7
0.875	200	0.116	0.5	3.3	9.1	17.9
1.000	200	0.058	0.63	4.0	11.0	21.7
1.000	200	0.116	0.59	3.86	10.58	20.8
1.125	200	0.058	0.71	4.6	12.6	24.7
1.125	200	0.116	0.69	4.4	12.2	23.8
1.250	200	0.058	0.80	5.1	14.1	27.7
1.250	200	0.116	0.77	4.9	13.7	26.8

FIGURE 3

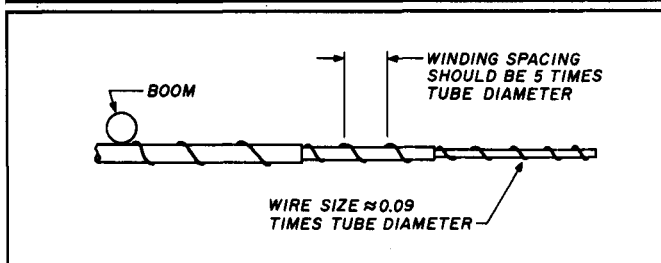

Experimental method for eliminating the creation of vortices by wrapping the elements with wire.

about 0.09 times the diameter of the element with the turns of the helix spaced about 5 times the diameter. (See Figure 3.) I don't know if anyone has tried this approach. I plan to experiment with it and I hope others will too. It offers the possibility of being the best solution. Rather than trying to accommodate the production of vortices, this approach may eliminate their generation. I know this idea has been applied successfully to various types of structures, like suspended pipelines and smoke stacks, but I'm not aware of its use with Yagi elements.

You can attempt to retune the mechanical resonances of the element out of the range of vortex shedding frequencies in two ways. One traditional method is to use damping ropes inside the elements. Actually, damping ropes provide both a slight mechanical retuning of the element and the addition of some amount of damping to lower the Q of the mechanical resonance. My experience with damping ropes has shown them to be of little value. I had four fatigue failures on a 20-meter Yagi and three on a 10-meter

Yagi in one year. All had ropes. After the first break on each, I changed the ropes to the largest possible size, with no success.

The amount of mechanical retuning that results from placing a rope inside an element is shown in Table 3. I've calculated the resonant frequencies with a 1/2-inch rope inside the entire element length. A comparison of Table 1 and Table 3 shows the resonant frequencies haven't been substantially altered. If anyone has had success with ropes, it probably has been due to a lowering of the Q of the mechanical resonance by providing some damping. This was probably a marginal case. Evaluate this method the same way you did the foamed elements. Perhaps you can enhance the damping provided by the rope by gluing its entire length to the inside of the element. You'll probably have to soak the rope in an adhesive and coat the inside of the element before pulling the rope through.

A weight fastened to the tip of an element can alter the resonant frequency appreciably. Table 4 shows the same element configurations, with a 3-ounce weight at the element tip. This table compares the first mode with and without the weight. There has been about a 40-percent reduction in resonant frequency. The second mode resonant frequency will be reduced further, while the higher modes' resonant frequencies will increase. I tested this on a 20-meter Yagi element and found that adding a 3-ounce weight cut the second mode frequency in half. The degree of retuning depends on element configuration and weight size.

Several years ago Dennis Peters, N5UA (now deceased), had a 10-meter beam which was losing an element about every two months even though he had ropes in the elements. After some discussion and much frustration on his part, he added weights to each element tip. Dennis used large washers secured with hose clamps; they did the trick.

DX-ing, contests, pile-ups, traffic handling. When you need to command attention, you will with the SB-1000 Linear Amplifier from Heath. And you'll do it for a cost that no one else can match.

From our recent DX-pedition to Taiwan, operators easily controlled pileups with the SB-1000 and nothing more than a dipole antenna. This means that when conditions are tough, you know you can depend on your SB-1000 to lift your signal above the rest. Whether you're using a dipole or stacked monoband beams.

Proven output power

We don't play games by using old rating methods to make you pay for input power you don't get at the antenna. What you do get is 1000 watt output of peak

envelope power on SSB and 850 watts on CW. Even 500 watt output on RTTY.

On the chance that someone might doubt our claims, at hamfests we demonstrate that with only 80 to 100 watts of drive, our SB-1000 develops more output than even the world-famous Heath SB-220!

Designed for today, the SB-1000 offers quiet, compact tabletop operation at rated output. That's only 1.7dB (or about 1/3 of an S-unit) below

the maximum legal power limit.

"I built it myself!"

Because you build the Heathkit SB-1000 Linear Amplifier yourself, you not only enjoy cost savings, you have the unique opportunity of knowing your equipment inside and out.

A top quality amplifier, cost savings, bragging rights, plus industry-recognized Heathkit manuals and technical assistance from our licensed ham consultants, should you ever need it. An offer that's hard to pass up.

See the SB-1000 and our complete line of amateur radio products in the Spring Heathkit Catalog. Call today for your free copy.

1-800-44-HEATH
(1-800-444-3284)

Best to start with.
Best to stay with.

Heath Company

Benton Harbor, Michigan 49022

Top
performance
for less than
80 cents
a watt



BAND



LOAD



Heathkit
SB-1000 LINEAR AMPLIFIER

MULTIMETER

PLATE CURRENT
HIGH VOLTAGE
POWER OUTPUT
ALC

TRANSMIT

PWR OPR

OFF STBY

© 1989, Heath Company.
Heathkit is a registered
trademark of Heath Company.
A subsidiary of Zenith
Electronics Corporation.



GET TWO BIRDS WITH ONE STONE DJ-500T DUAL BAND HAND-HELD

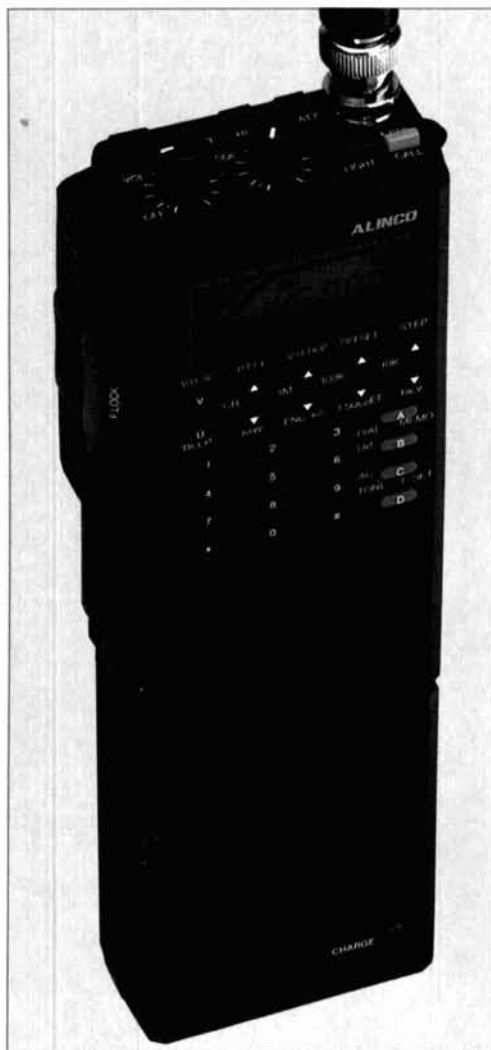

Engineered with the most advanced electronic technology, the Tiny, Tough and Terrific DJ-500T features two methods of Frequency Selection, Encode/Decode Subaudible Tones and a Single memory - 16 Digit Auto Dialer and the following plus:

- ▶ 144.00Mhz - 147.995 Mhz / 440-450 Mhz (Frequency Coverage is Modifiable[☆])
 - ▶ Ultra Compact: 2 5/16" (W) x 7 1/2" (H) x 1 1/2" (D)
 - ▶ Cross Band Full Duplex
 - ▶ High Power Output: 2.5W (VHF) / 2.0W (UHF) with Standard Ni-Cd battery
6Watts (VHF) / 5 Watts (UHF) with Optional Battery*
 - ▶ Two methods of Frequency Selection
Direct keyboard entry and small, quick up and down adjustments.
 - ▶ Automatic Battery Save Function
 - ▶ All Ni-Cd batteries have unique DC/DC converter for 13.8VDC input
 - ▶ Programmable Odd Offsets
- 20 Memory Channels (10 each band)
 - Multiple Battery Options
 - 10 db RF Attenuator
 - Illuminated LCD
 - Function Lock
 - Unique Priority Function
- [☆] CAP and MARS modifiable (Permit required)

2-Year Limited Factory Warranty

DJ-100T

2m FM Transceiver

- ▶ 3 Watts/Standard
- ▶ 6.5 Watts/Optional

DJ-200T

220Mhz FM Transceiver

- ▶ 2.5 Watts/Standard
- ▶ 5 Watts/Optional

- ▶ LCD read out
- ▶ 10 Memories
- ▶ Dipswitch Programmable Subaudible Tone built-in
- ▶ MARS and CAP modifiable (DJ - 100T) (Certificate required)



6 WATTS VHF
*** 5 WATTS UHF**

(* With Optional EBP-8NAZ or 13.8VDC input)

ALINCO'S Products are Carried by These Fine Dealers

A-Tech Electronics - Burbank, CA
 ACK Radio Supply - Birmingham, AL
 Amateur & Advance Comm. - Wilmington, DE
 Amateur Comm. ETC. - San Antonio, TX
 Amateur Electronic Supply - Milwaukee, WI
 Amateur Electronic Supply - Orlando, FL
 Amateur Electronic Supply - Clearwater, FL
 Amateur Electronic Supply - Las Vegas, NV
 Austin Amateur Radio Supply - Austin, TX
 Barry Electronics - New York, NY
 Colorado Comm. Center - Denver, CO
 Delaware Amateur Supply - New Castle, DE
 EL Original Electronics - Brownsville, TX
 Electro-Com - Tacoma, WA
 EEB - Vienna, VA
 Erickson Communications - Chicago, IL
 F & M Electronics - Greensboro, NC

Floyd Electronics - Collinsville, IL
 The Ham Station - Evansville, IN
 The Ham Hut - Amarillo, TX
 Henry Radio - Los Angeles, CA
 Hirsch Sales Co. - Williamsville, NY
 HR Electronics - Muskegan, MI
 Ham Radio Outlet - Anaheim, CA
 Ham Radio Outlet - Atlanta, GA
 Ham Radio Outlet - Burlingame, CA
 Ham Radio Outlet - Oakland, CA
 Ham Radio Outlet - Phoenix, AZ
 Ham Radio Outlet - Salem, NH
 Ham Radio Outlet - San Diego, CA
 Ham Radio Outlet - Van Nuys, CA
 Ham Radio Outlet - Woodbridge, VA
 HSC - Santa Clara, CA
 HSC - Sacramento, CA

HSC - Sunnyvale, CA
 International Radio Systems - Miami, FL
 Jun's Electronics - Culver City, CA
 KComm - San Antonio, TX
 KJI Electronics - Houston, TX
 Madison Electronics - Houston, TX
 Maryland Radio Center - Laurel, MD
 Michigan Radio - Mt. Clemens, MI
 Mission Communications - Houston, TX
 Missouri Radio Center - Kansas City, MO
 N & G Electronics - Miami, FL
 Omni Electronics - Laredo, TX
 Quement Electronics - San Jose, CA
 RF Enterprises - Merrifield, MN
 R & L Electronics - Hamilton, OH
 Radio World - Boulder City, NV

Reno Radio - Reno, NV
 Rivendell Associates - Derry, NH
 Rogus Electronics - Southington, CT
 Rosen's Electronics - Williamson, WV
 Ross Distributing Co. - Preston, ID
 Satellite City - Minneapolis, MN
 Soundnorth - S. Int'l Falls, MN
 Tel-Com Electronic Comm. - Littleton, MA
 Texas Comm. Center - Houston, TX
 Universal Amateur Radio - Columbus, OH
 VHF Communications - Jamestown, NY
 Williams Radio Sales - Colfax, NC

CANADA
 Canadian Distributor
 Texpro Sales Inc. - Burlington, Ontario
 (416) 332-5944

WANTED

\$100.⁰⁰ REWARD



\$50.⁰⁰ REWARD



For a limited time Alinco Electronics will give a \$100.00 "Reward" for your working, 2 meter or 70 centimeter Mobile Transceiver, or \$50.00 for your working 2 meter or 70 centimeter Hand-Held Transceiver.

The way it works is really quite simple. Just take or send your old, but working, transceiver to your favorite dealer for **TRADE-IN**. Whatever the dealer offers for Trade-In allowance, Alinco will increase the amount by either \$50.00 or \$100.00, depending on whether it's a Hand-Held or Mobile, **ON THE SPOT!** There are only two requirements:

- 1) The Trade-In "Reward" can only be used towards an Alinco DR-510T Dual Band Mobile or an Alinco DJ-500T Dual Band Hand-Held, on a Mobile for Mobile and Hand-Held for Hand-Held basis.
- 2) The Trade-In unit must be in good working order and salable.

Remember, the company that already gives you the best value for your dollar, and a two year factory warranty, now gives you something else that no other company does – A substantial Trade-In "Reward" for using our products!

OFFER GOOD AT TIME OF SALE ONLY. OFFER EXPIRES AUGUST 31, 1989

ALINCO ELECTRONICS INC.



If You Want the Most Advanced TNC Today...

In 26 countries around the world, tens of thousands of amateurs know that Kantronics is the leader in bringing tomorrow's technology to their stations today. They also know they will always be among the first to incorporate just-introduced features and modes with Kantronics software and firmware updates.

And, they know that Kantronics is unique in its ability to seek out, develop and incorporate the most advanced features into each of five different TNC models before anyone else. Why? Because every program Kantronics writes, and every unit Kantronics designs and produces are born right here at the factory in the U.S.A.

Meet Your Mailman

In this age of telco LANS, E-mail and FAX,



PBBS is just one of the firsts Kantronics delivered.

you will know you have mail in your **Personal Packet Mailbox™** when your KAM "STA" LED is blinking. New firmware level 2.85 has also added a handy automatic mailbox user-

connect. So save your computer and monitor life by turning them off when you are away, and never miss a beat on the airwaves.

Version 2.85 KAMs have increased Packet Cluster™ compatibility, **KA-NODE™** path preservation, **KA-NODE** recognition of the "NET" nodes and HF baud rates from 50 through 300! And there are three new mailbox commands: *List Mine, Read Mine* and *Kill Mine*.

and Tomorrow...

Will the Real Dual-Port Please Stand Up?

Read our lips. **The KAM™ is the only true dual-port when it comes to packet.** Your Personal Packet Mailbox™ is accessible from both HF and VHF! Version 2.85 has dual-port compatibility with RLI/MBL boards and KISS mode for both ports. You can monitor HF and VHF packet operations at the same time. Users can even gateway from HF to VHF (or in reverse) through your KAM.

Kantronics All-Mode™ (KAM) has Packet, WEFAX, ARQ, FEC, RTTY and CW reception. But we have five models to suit your particular taste. **Ask your dealer for the best choice today...and tomorrow.**

Kantronics
RF Data Communications Specialists

1202 E. 23rd Street Lawrence, Kansas 66046
(913) 842-7745

TABLE 4

Resonant frequencies of mode 1 without and with a 3-ounce tip weight.

Tube diameter (inches)	Element half length (inches)	Wall thickness (inches)	Mode 1, no tip weight (Hz)	Mode 1, with tip weight (Hz)
0.500	100	0.058	1.2	0.7
0.625	100	0.058	1.6	1.0
0.750	100	0.058	1.9	1.27
0.875	100	0.058	2.3	1.51
0.500	135	0.058	0.7	0.44
0.625	135	0.058	0.9	0.57
0.750	135	0.058	1.1	0.70
0.875	135	0.058	1.2	0.84
1.000	135	0.058	1.4	0.97
0.625	200	0.058	0.4	0.27
0.625	200	0.116	0.36	0.25
0.750	200	0.058	0.5	0.33
0.750	200	0.116	0.45	0.31
0.875	200	0.058	0.6	0.39
0.875	200	0.116	0.5	0.37
1.000	200	0.058	0.7	0.45
1.000	200	0.116	0.6	0.43
1.125	200	0.058	0.75	0.51
1.125	200	0.116	0.7	0.49
1.250	200	0.058	0.83	0.57
1.250	200	0.116	0.79	0.55

FIGURE 4

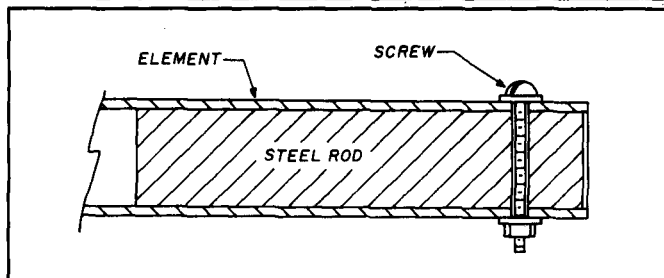

Adding weight to reduce the mechanical resonant frequency.

The antenna suffered no failures in the year before his station was dismantled.

Add weights by clamping them to the outside of the element or securing them to the inside. You can slip lengths of steel rod into the tip of an element and secure them with screws. (Figure 4 shows this method of attachment.) If you add weights, they can't be taped to the element. They must be hard mounted.

There are two preferred locations for adding weights. The first is at the tip. Another spot is about one-fifth of the way from the tip to the boom. The tip moves the most in modes 1 and 2; the second location moves substantially in mode 2. Adding weights loads these locations for the most dramatic retuning. Observe the shape the element takes when it's fluttering in order to determine weight placement. You'll see a displacement peak at the tip, and another part way to the boom. Put the second weight at the second peak. In Figure 1, the second peak is labeled for mode 2.

Boom flutter

I've seen booms fluttering on several occasions. One boom eventually failed at the mast end. This failure isn't as common as element flutter, but it does happen. The cases I've observed have all had boom support wires strung from the mast to the boom. For the boom in Figure 5, the resonant frequency with the support wires is 7.3 Hz. Without the support wires, the resonant frequency is 0.77 Hz. Getting rid of the wire drops the resonant frequency substantially, but a lack of support wires may not be acceptable. Fortunately, there's an easy solution to the problem. The key is to provide the support needed, but not the stiffness of the support wire. Install a spring in the support wire as shown in Figure 6. The softer the spring the better. Pick a spring, or series of springs, that won't be stretched excessively by the tension needed to support the boom. This will

FIGURE 5

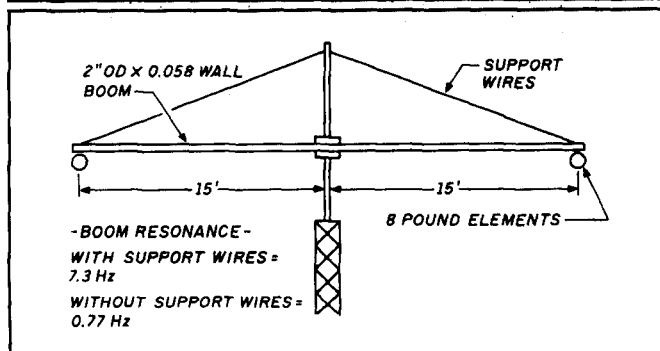

Case where boom with support is more prone to flutter.

FIGURE 6

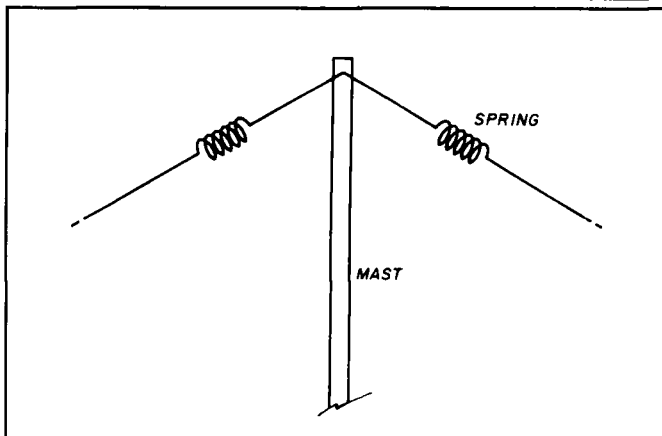

Installing stiff springs in the boom support lines to damp the resonant frequency.

decouple the stiffness of the support wire and still provide the needed tension. The shift in resonant frequency will most likely put the boom into an area where either the energy in the wind stream isn't sufficient to start flutter, or the boom resonant frequency is below the vortex shedding minimum.

Element design variations

I've had Yagis with severe fluttering problems. I've also had Yagis with no problems at all. Those having failures were very stiff when compared with their mass, while those that had no damage weren't as stiff when compared with their mass. In Equations 1 through 4, the term $\frac{EI}{u}$ appears.

EI is a stiffness term, and u is a mass term. The lower the "stiffness to mass" ratio, the lower the mode resonances. Based on the Yagis I have owned, I've concluded that elements with the lower resonant frequencies have the best chance of not fluttering. This suggests that retuning the element is indeed a viable approach, a fact supported by the experiences of Dennis Peters. I'd be very interested in hearing from any readers who have experienced problems with fluttering elements, whether you've been successful at solving them or not.

Summary

Elements and booms have mechanical resonant frequencies which can be put into oscillation by vortices shedding from the tube edges. There are several ways to reduce the likelihood of a fatigue failure. Damping can be added to reduce the amplitude of the stress. This would lengthen the life of the element. Adding damping ropes may help in marginal cases. Other methods have been tried, and there is certainly room for innovation. You can test an idea on the ground to see if it will reduce the Q of the mechanical resonance by noting the time it takes for oscillatory motion to damp out.

The most promising approach for minimizing element fatigue failures is to eliminate the orderly generation of vortices. The orderly formation of vortices will be disrupted in an element which is helically wound with a wire. To the best of my knowledge, this approach hasn't been tried with Yagis. It may prove to be the most effective remedy for fluttering elements.

There's a successful approach that's been used to eliminate element fatigue failures. Retuning the resonant frequencies of an element offers a means to prevent fatigue failure by moving the element resonances out of the shedding frequency range. You can do this by adding small weights. At minimum, the weights should be added at the element tips. A second location is on the span of the element, at the point with the largest displacement during a mode 2 oscillation. In addition, when selecting or designing a Yagi, keep in mind that elements which aren't very stiff in relation to their mass are less prone to vibration-induced fatigue failures.

Yagi booms are also subject to vortex shedding and fatigue failures. Booms with support wires have been observed to be most prone to fluttering. You can retune a boom with support wires by the adding springs in line with the wires. This lowers the resonant frequency of the boom and prevents it from fluttering. **77**

REFERENCES

1. C.M. Harris and C.E. Creede, *Shock and Vibration Handbook*, Second Edition, McGraw-Hill Book Company, 1976, pages 1-14
2. R.L. Daugherty and J.B. Franzini, *Fluid Mechanics with Engineering Applications*, Seventh Edition, McGraw-Hill Book Company, 1977, page 301
3. C.J. Richards, et al., *Mechanical Engineering in Radar and Communications*, D. Van Nostrand Reinhold Company, 1969, page 208
4. H.O. Fuchs and R.J. Stephens, *Metal Fatigue in Engineering*, John Wiley & Sons, 1980, page 14.
5. C. Scruton and D.E.J. Walshe, *A Means for Avoiding Wind-Excited Oscillations of Structures with Circular or Nearly Circular Cross Section*, Aero Report No. 335, N.P.L., Teddington, Middx 1957.

RFI KIT

Use ferrite beads to keep RF out of your TV, stereo, telephone, etc. Kit includes one dozen beads, one dozen toroids 1/2" to 1 1/4" diameter, three "split beads" and our helpful RFI tip sheet. Everything needed to fix most RFI problems. **\$15 + \$3 shipping U.S. and Canada. 7% in CA.**

Free catalog and RFI tip sheet on request.

PALOMAR ENGINEERS

Box 455, Escondido, CA 92025
Phone: (619) 747-3343

NEW!
The classic "Antenna Bible"
now in a thoroughly-revised, much-enlarged
edition

ANTENNAS

2nd edition
by John Kraus, W8JK
Ohio State University

Covers both theory and its applications to practical systems. With design formulas, tables and references. Over 1000 illustrations.

"Modern, complete, a classic", *Microwave Journal*.

917 pages, hardcover. \$51.95

Add \$2.50 per book for shipping and handling U.S., \$5.00 elsewhere.

CYGNUS-QUASAR BOOKS
P.O. Box 85, Powell, Ohio 43065
Tel. 614-548-7895

INDUSTRIAL QUALITY REPLACEMENT BATTERIES FOR COMMUNICATIONS

Nickel-Cadmium, Alkaline, Lithium, etc.

Repair Packs For
ICOM®, KENWOOD, YAESU,
SANTEC, AZDEN, TEMPO,
CORDLESS PHONES...AND MORE!

NEW! I.C.E. PACK \$49⁹⁵



E.H. YOST & CO.
EVERETT H. YOST KB9XI
7344 TETIVA RD.
SAUK CITY, WI 53583
ASK FOR OUR CATALOG
(608) 643-3194

HENRY RADIO IS THE PLACE ...THE BEST PLACE to fill all your data communications needs



The TEMPO MPP1

...a unique new mobile data printer, includes a packet controller and a 13.6 VDC printer that interfaces with any mobile radio. In a recent user test it proved to have about twice as much audio level range tolerance as other TNCs. It is also an ideal unit for emergency work and a commercial version is perfect for dispatching service, emergency and police vehicles.

The FSTV-430, AEA's newest

The exciting FSTV-430 fast scan television transceiver makes getting on ATV easy and inexpensive...live or taped. Almost any video camera can be used. Simply plug it into the FSTV-430, connect to your 70 cm antenna and you're on the air. Use a standard TV for receiving signals and, of course, an amplifier will extend your range. It's reliable, portable and light weight and can be used in-station or mobile from any 12 VDC source. The only license required is a technician or higher.



The PK-232 by AEA

...the only controller offering Morse Code, Baudot, ASCII, AMTOR, Packet, and facsimile Transmission & Reception plus the ability to monitor the new Navtex marine weather and navigational system...7 modes in one controller. The PK-232 makes any RS-232 compatible computer or terminal the complete amateur digital operating position. All decoding, signal processing and protocol software is on ROM. Only a simple terminal program (like those used with telephone modems) is required to interface the PK-232 with your computer.

Obviously, we can fill in a system that you have already started. Or we can furnish a complete system to fit your needs and budget. For example, here's some suggestions for the amateur just entering the exciting field of data communications, or: for the amateur who wants the best available.

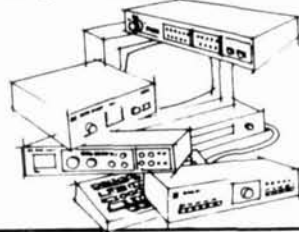

NO. 1 For the fun (and very affordable) mode, VHF Packet, AEA PK-88 with personal mailbox, 8K programmable memory and TCP-1 P compatibility. For serious 20 M world-wide DXing on Packet, 200 or 600-Hz shift...add the superb HAL ST-7000.

NO. 2. . .top of the line! The HAL ST-8000 or HAL ST-6000 and AEA's PK-232...the winning combination. You can't do better for all-mode, all-band enjoyment of hi-speed data communications.

If you have any questions concerning these units, or would like to discuss your requirements with a knowledgeable specialist, please call and ask for George Sanso, AB6A. We also carry a large selection of excellent commercial products for data communications and emergency systems as well as a complete inventory of amateur equipment and linear power amplifiers.



Henry Radio

2050 S. BUNDY DR. • LOS ANGELES, CA 90025 • (213) 820-1234
Toll free order number: (800) 877-7979 TELEX: 67-3625(Henradio) FAX (213) 826-7790

THE BATTLE OF THE BEAMS

PART 2

By D. V. Pritchard, G4GVO, 55 Walker Dr., Leigh on Sea, Essex SS9 3QT, England

As early as 1934, when *Knickebein* was in its infancy, a German scientist began to have doubts about its efficiency if exposed to jamming. He was Staatsrat (Privy Councillor) Dr. H. Plendl of the Deutsche Versuchsanstalt für Luftfahrt (German Aeronautical Research Establishment) and he began to produce designs for a new system for accurate blind bombing.

Under his leadership, a new department was formed at Rechlin (the German equivalent of Farnborough) which began research in June of that year. This was in cooperation with another department led by a Dr. W. Kühnold which was also engaged on beam techniques for blind landing. The beams of Kühnold's system, however, had an aperture angle of about 5°, corresponding to an 8-km beamwidth at a range of 100 km, and were clearly unsuitable for accurate pinpointing of targets. Obviously a beam width of not more than 0.1° was required and this (at that time) could be attained with reasonable antenna dimensions and suitable power only if a frequency between 66 and 77 MHz were employed. Accordingly, experiments were begun with an 80-watt transmitter designed by a Dr. Ochmann which was code named *Bertha 1*; as this was not powerful enough a second was designed, *Bertha 2*, which delivered 500 watts and was tunable over the required range.

Preliminary tests carried out over Lake Müritz near Mecklenburg in 1935 resulted in ranges of only 1500 meters. Stationary beam antennas which could be phased to swing through about 10° were used, and the airborne equipment consisted of two t.r.f. receivers developed at Rechlin and an analyzer for unlocking the 2000-Hz modulated dot/dash system of the adopted and improved *Knickebein* apparatus. Unfortunately, full details of both transmitter and receivers are no longer available.

Wotan 1

By 1938, the system had been greatly improved. Dr. Kühnold had developed ground installations capable of easy dismantling and removal, with an operating cabin and

antenna array mounted on a platform which could rotate through 360°. The antennas were mounted on a gantry and spaced at 14.75 meters (3.5 wavelengths). Originally, simple half-wave dipoles were employed, but before long directors and reflectors were added for extra power and range; these were energized with pulses at 120 per minute via a vacuum switch (soon replaced by a capacitor, nicknamed a "mill switch," designed by Dr. K. H. Fischer). The schematic block diagram of this system is shown in **Figure 1**. A half-wave Lecher line is used in conjunction with the "capacity" switch and its associated inductances to pulse both dipoles with the required dot/dash sequence.

The array generated a fan of 14 beams each with a bandwidth of 0.05° (**Figure 2**), and eight of these installations were erected in Germany, followed by many more on the coasts of occupied Europe. By now the airborne equipment had also been drastically improved by Dr. H. Hanel and Dr. Rücklin Telefunken, who had designed and developed a superhet for 66 to 77 MHz (code named *Anna*), while an analyzing system designed by Dr. Plendl known as the AVP (Anzeige-Verfahren von Plendl) was being mass-produced by Siemens.

At the same time a Dr. K. Müller set up a Mobile Research Unit which produced some versatile mobile stations under the code name *Möbelwagen* or "furniture vans." He was also responsible for the clever camouflaging of their antenna — a feature which was later to prove troublesome for British counterattacks.

The complete system was known as *Wotan 1*.

Principle of operation

One of the 14 beams was selected to act as a director beam which, on being aimed towards the target, provided a flight path for the aircraft; this system was similar to *Knickebein* in that the pilot could plot his course according to a direction-indicating meter which told him if he was to the right or left of the beam. The official German layout of the beam-approach system and its associated cross-beams at points before the target is shown in **Figure 3**. **Figure 4** represents not only the director beam and reserve beam, but also the cross-beams and the associated fans of beams which enabled stray aircraft to plot their courses to the correct one. The main beams of the system used for the devastating raid on Coventry in 1940 are shown in **Figure 5**, and **Figure 6** is another official German layout showing

FIGURE 1

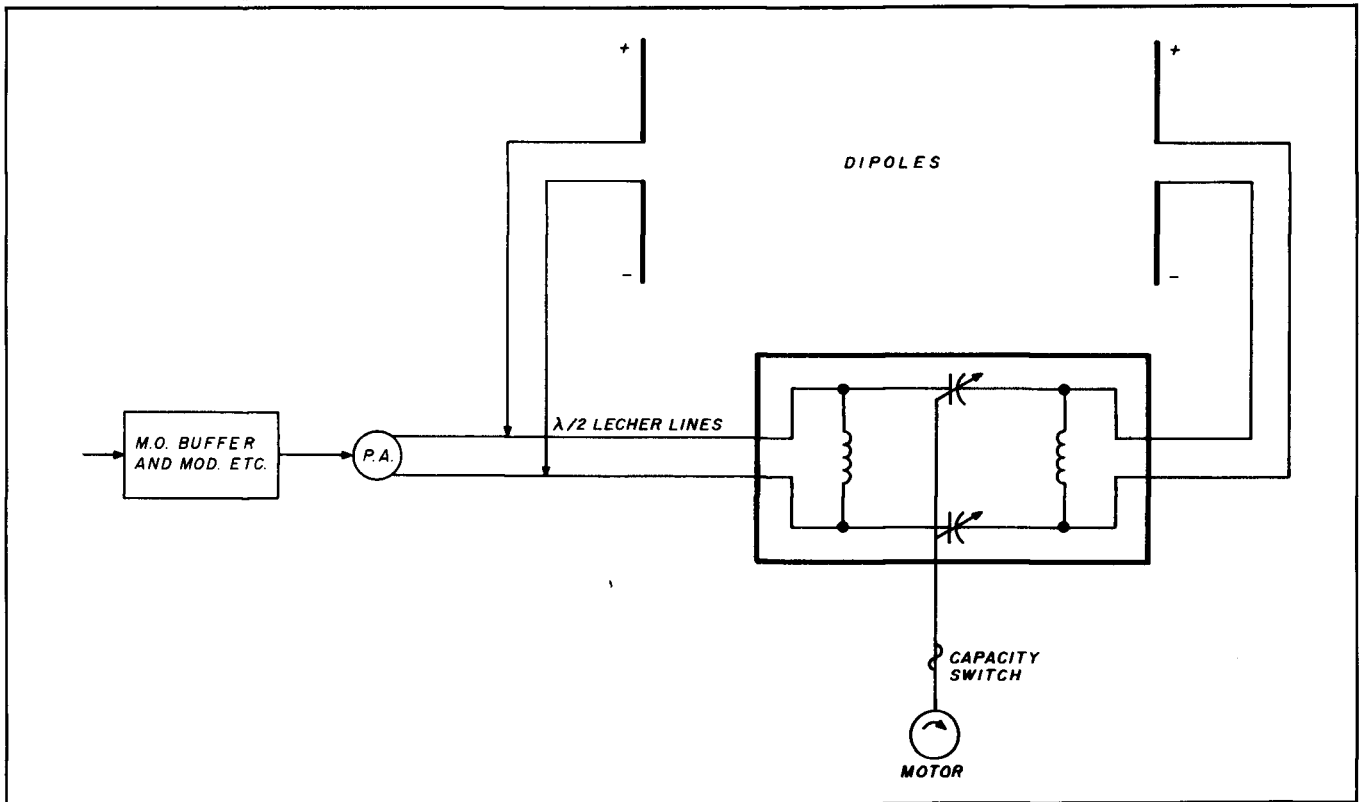

Block diagram of X-Gerät feed system and capacity switch for pulsing.

FIGURE 2

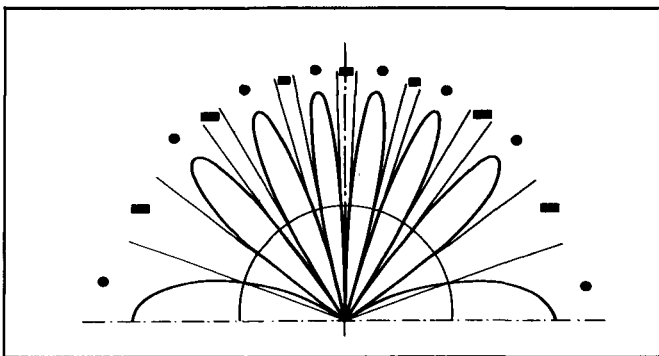

Antenna pattern of X-Gerät system.

the disposition of all beam systems in use at that time. (In this series the author has concentrated only on the more widely known systems.)

In practice the bombers did not fly along the director beam immediately after takeoff, but used either normal navigational methods or one of the fan beams, in order to present a smaller target for British radar and to try to cause confusion. The director beam was usually joined sometime after crossing the English coast.

At approximately 30 km before the target, the aircraft would encounter the coarse advanced cross-beam which, like the other beams, was similarly pulsed with dots and dashes — but on a different frequency. Before reaching this

FIGURE 3

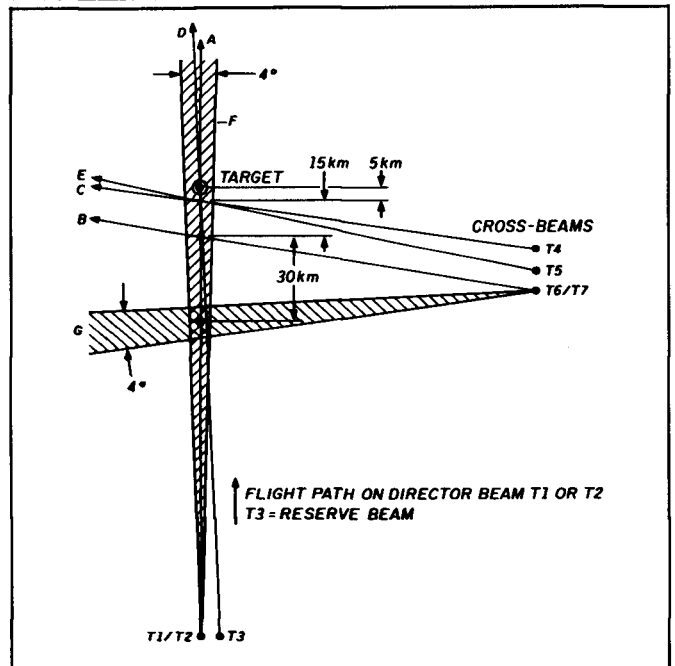

Official German layout of the X-Gerät system.

point, the bomber's radio operator would have consulted a table giving the characteristics of his particular type of



INSIDE VIEW — RS-12A

ASTRON POWER SUPPLIES

• HEAVY DUTY • HIGH QUALITY • RUGGED • RELIABLE •

SPECIAL FEATURES

- SOLID STATE ELECTRONICALLY REGULATED
- FOLD-BACK CURRENT LIMITING Protects Power Supply from excessive current & continuous shorted output
- CROWBAR OVER VOLTAGE PROTECTION on all Models except RS-3A, RS-4A, RS-5A.
- MAINTAIN REGULATION & LOW RIPPLE at low line input Voltage
- HEAVY DUTY HEAT SINK • CHASSIS MOUNT FUSE
- THREE CONDUCTOR POWER CORD
- ONE YEAR WARRANTY • MADE IN U.S.A.

PERFORMANCE SPECIFICATIONS

- INPUT VOLTAGE: 105-125 VAC
- OUTPUT VOLTAGE: 13.8 VDC \pm 0.05 volts (Internally Adjustable: 11-15 VDC)
- RIPPLE Less than 5mv peak to peak (full load & low line)
- Also available with 220 VAC input voltage



MODEL RS-50A



MODEL RS-50M



MODEL VS-50M

RM SERIES



MODEL RM-35M

19" \times 5 1/4" RACK MOUNT POWER SUPPLIES

MODEL	Continuous Duty (Amps)	ICS* (Amps)	Size (IN)		Shipping Wt. (lbs.)
			H	W \times D	
RM-12A	9	12	5 1/4	19 \times 8 1/4	16
RM-35A	25	35	5 1/4	19 \times 12 1/2	38
RM-50A	37	50	5 1/4	19 \times 12 1/2	50
• Separate Volt and Amp Meters					
RM-12M	9	12	5 1/4	19 \times 8 1/4	16
RM-35M	25	35	5 1/4	19 \times 12 1/2	38
RM-50M	37	50	5 1/4	19 \times 12 1/2	50

RS-A SERIES



MODEL RS-7A

MODEL	Continuous Duty (Amps)	ICS* (Amps)	Size (IN)		Shipping Wt. (lbs.)
			H	W \times D	
RS-3A	2.5	3	3	4 3/4 \times 5 3/4	4
RS-4A	3	4	3 3/4	6 1/2 \times 9	5
RS-5A	4	5	3 1/2	6 3/4 \times 7 1/4	7
RS-7A	5	7	3 3/4	6 1/2 \times 9	9
RS-7B	5	7	4	7 1/2 \times 10 3/4	10
RS-10A	7.5	10	4	7 1/2 \times 10 3/4	11
RS-12A	9	12	4 1/2	8 \times 9	13
RS-12B	9	12	4	7 1/2 \times 10 3/4	13
RS-20A	16	20	5	9 \times 10 1/2	18
RS-35A	25	35	5	11 \times 11	27
RS-50A	37	50	6	13 3/4 \times 11	46

RS-M SERIES



MODEL RS-35M

MODEL	Continuous Duty (Amps)	ICS* (Amps)	Size (IN)		Shipping Wt. (lbs.)
			H	W \times D	
• Switchable volt and Amp meter					
RS-12M	9	12	4 1/2	8 \times 9	13
• Separate volt and Amp meters					
RS-20M	16	20	5	9 \times 10 1/2	18
RS-35M	25	35	5	11 \times 11	27
RS-50M	37	50	6	13 3/4 \times 11	46

VS-M AND VRM-M SERIES



MODEL VS-35M

- Separate Volt and Amp Meters • Output Voltage adjustable from 2-15 volts • Current limit adjustable from 1.5 amps to Full Load

MODEL	Continuous Duty (Amps)			ICS* (Amps)	Size (IN)		Shipping Wt. (lbs.)
	@13.8VDC	@10VDC	@5VDC		H	W \times D	
VS-12M	9	5	2	12	4 1/2	8 \times 9	13
VS-20M	16	9	4	20	5	9 \times 10 1/2	20
VS-35M	25	15	7	35	5	11 \times 11	29
VS-50M	37	22	10	50	6	13 3/4 \times 11	46
• Variable rack mount power supplies							
VRM-35M	25	15	7	35	5 1/4	19 \times 12 1/2	38
VRM-50M	37	22	10	50	5 1/4	19 \times 12 1/2	50

RS-S SERIES



MODEL RS-12S

- Built in speaker

MODEL	Continuous Duty (Amps)	ICS* Amps	Size (IN)		Shipping Wt. (lbs.)
			H	W \times D	
RS-7S	5	7	4	7 1/2 \times 10 3/4	10
RS-10S	7.5	10	4	7 1/2 \times 10 3/4	12
RS-12S	9	12	4 1/2	8 \times 9	13
RS-20S	16	20	5	9 \times 10 1/2	18

FIGURE 4

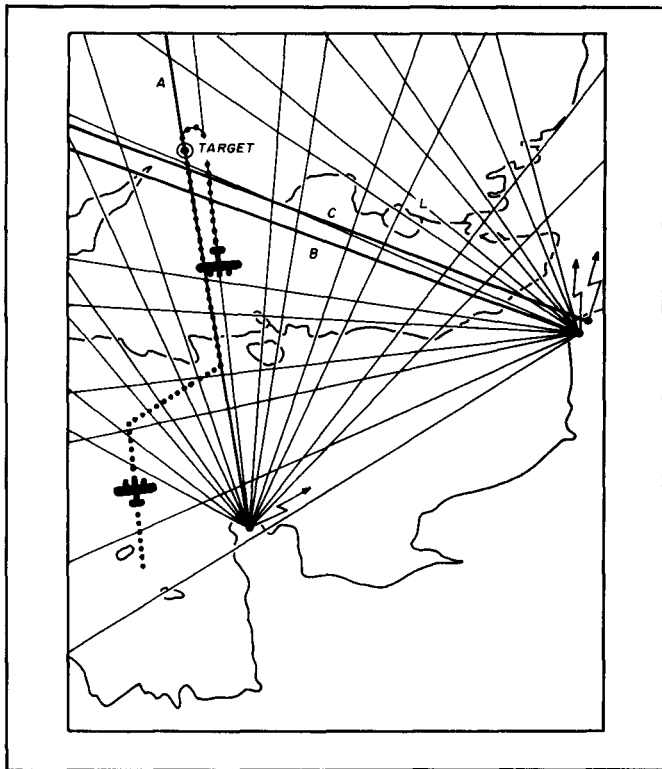

German layout of beams showing main beams and associated fans.

machine and fed them into a combined calculator and stopwatch called the *X-Uhr*, or "X-Clock." This was an incredibly accurate mechanism designed at Rechlin by a Dr. Hepper. A small upper dial on the left-hand side showed how long the instrument had been running, while the lower dial was used for calculating the "flight-path ratios." Information about the aircraft's type, height, and speed was inserted to give a flight-path ratio of, say, 2.78:1 for 18 km or 3:1 for 6 km, according to circumstances.

On arriving in the dash zone of the advanced cross-beam, the operator would listen for the (very brief) continuous note produced by the merging of dots and dashes, and press the clock's top button. This started the green "minute" hand and the black sweep hand simultaneously and, according to the inserted data, the time taken for the bombs to drop was now fed in.

At the "fore-cross signal" a button on the left was pressed, whereupon the green and black hands stopped and the red "hour" hand started. When the third button at the main cross-beam was pressed, the red hand would stop at the same point as the previous ones and, if the correct data had been given, the bombs would be automatically released.

After tests by a research squadron, the system was finally installed in Ju 52s and He 111s of *Kampf-Gruppe 100* — a group led by an outstanding Luftwaffe officer, Major Viktor von Lossberg. Quarter-wave whips were mounted on top of the fuselage behind the cockpit and these, in conjunction with the whip antenna for RT operation which was situated farther back, gave rise to the nickname "Three-master."

FIGURE 5

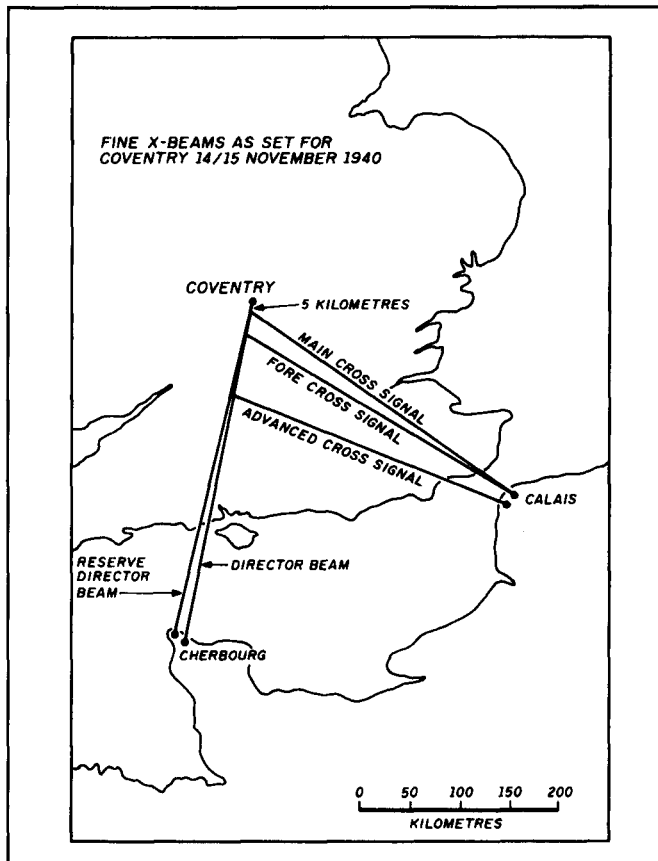

The X-Gerät system for Kampf-Gruppe 100.

The airborne equipment was installed in the radio operator's position, and repeaters for the course meters were fitted in the cockpit for the pilot's benefit. A motor generator fed from the aircraft's batteries (rotary converter) was placed at the bottom of the installation. Immediately above it were two audio units, to the left of which was the power distribution panel. The twin receivers for the director and cross-beams were above that and the Anna receiver was on the right.

Intelligence breakthrough

The phone shattered Dr. R. V. Jones's sleep in the early hours of a morning during the first week of September 1940.

"We've got something new here! God knows what it is, but I'm sure it's something for you!"

The excited voice of Professor Frederick "Bimbo" Norman, a cryptographer at Bletchley Park, shook Jones into consciousness. They had broken some new Enigma traffic in which radio beams were mentioned, including the information that the beam width was 8 to 10 seconds of arc, or an angle of 1:20,000, suggesting that *the beam was no wider than about 20 meters at 320 km!*

Then came the electrifying word X-Gerät! Whatever X-Gerät was, it was being installed in aircraft of *Kampf-Gruppe 100*, one of the Luftwaffe's crack squadrons.

Jones hustled the intelligence services into greater activity. Across the Channel the Resistance organizations

HITACHI SCOPES AT DISCOUNT PRICES



V-212

\$419

List \$560
Save \$141

20MHz Dual Trace Oscilloscope

All Hitachi scopes include probes, schematics and Hitachi's 3 year warranty on parts and labor. Many accessories available for all scopes.

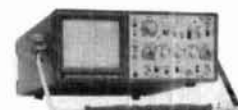

V-425
List \$995 **\$835**

- DC to 40MHz
- Dual Channel
- CRT Readout
- Cursor Meas
- DC Offset
- Alt Magnifier
- Compact Size



V-1060
List \$1595 **\$1,325**

- DC to 100MHz
- Dual Channel
- Delayed Sweep
- CRT Readout
- Sweep Time
- Autorangeing
- Trigger Lock
- 2mV Sensitivity

	LIST	PRICE	SAVE
V-223 20MHz	\$770	\$695	\$75
V-422 40MHz	\$875	\$725	\$150
V-423 40MHz	\$955	\$825	\$130
V-660 60MHz	\$1,195	\$1,025	\$170
V-1065 100MHz	\$1,895	\$1,670	\$225
V-1100A 100MHz	\$2,295	\$2,045	\$250
V-1150 150MHz	\$3,100	\$2,565	\$535

ELENCO PRODUCTS AT DISCOUNT PRICES

20MHz Dual Trace Oscilloscope

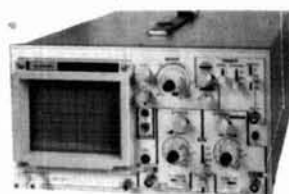

\$359
MO-1251

- 6" CRT
- Built in component tester
- TV Sync X-Y Operation

SCOPE PROBES

P-1 65MHz, 1x, 10x \$19.95

P-2 100MHz, 1x, 10x \$23.95

Fits all scopes with BNC connector

35MHz Dual Trace Good to 50MHz



\$495
MO-1252

- High luminance 6" CRT
- 1mV Sensitivity
- 6KV Acceleration Voltage
- 10ns Rise Time
- X-Y Operation • Z Axis
- Delayed Triggering Sweep

Top quality scopes at a very reasonable price. Contains all desired features. Two 1x, 10x probes, diagrams and manual. Two year guarantee.

Autoranging DMM



M-5000
\$45

- 9 Functions
- Memory and Data hold
- 1/2% basic acc
- 3 1/2 digit LCD

True RMS 4 1/2 Digit Multimeter



M-7000
\$135

- .05% DC Accuracy
- .1% Resistance with Freq. Counter and deluxe case

Multimeter with Capacitance and Transistor Tester



CM-1500
\$55

- Reads Volts, Ohms, Current, Capacitors, Transistors and Diodes with case

Digital Capacitance Meter



CM-1550
\$58.95

- 9 Ranges
- .1pf-20,000ufd
- .5% basic acc
- Zero control with case

Digital LCR Meter



LC-1801
\$125

- Measures Coils 1uH-200H
- Caps .1pf-200uf
- Res .01-20M

AC Clamp-On Current Adapter



ST-265
\$22

- 0-1000A AC
- Works with most DMM

Bench DMMS



M-3500
3 1/2 digit .1% accy

M-4500
4 1/2 digit .05% accy

SOLDERING STATION TEMPERATURE CONTROLLED



SL-30
\$135

- Digital display
- Temp range: 300F-900F
- Grounded tip
- Overheat prot

Solderless Breadboards



- 9430 1,100 pins \$15
- 9434 2,170 pins \$25
- 9436 2,860 pins \$35
- All have color coded posts

Low Cost Multimeter



M-1600
\$25

- 3 1/2 digit LCD
- 1% DC Accy
- 10A Scale
- Auto zero /polarity

Wide Band Signal Generators



SG-9000
\$129

- RF Freq 100K-450MHz
- AM Modulation of 1KHz
- Variable RF output

SG-9500 with Digital Display and 150MHz built-in Freq Ctr \$249

3 1/2 Digit Probe Type DMM



M-1900
\$39

- Convenient one hand operation with batteries and case
- Measures DCV, ACV, Ohms
- Audible continuity check, Data hold

Function Generator



#9600
\$28.95

- Provides sine, tri, squ wave
- From 1Hz to 1MHz
- AM or FM capability

Decade Blox



9610 or 9620
\$18.95

- #9610 Resistor Blox 47 ohm to 1M & 100K pot
- #9620 Capacitor Blox 47pf to 10MFD

Digital Triple Power Supply



XP-660
\$249

- Fully Regulated, Short circuit protected with 2 Limit Cont., 3 Separate supplies

XP-660 with Analog Meters \$175

Quad Power Supply



XP-580
\$59.95

- Fully regulated and short circuit protected

XP-575 without meters \$39.95

10MHz XT 100% IBM® Compatible

5 Year Warranty



\$595
MODEL PC-1000

- 5/10MHz Motherboard
- 8 Expansion Slots
- Math Compressor Slots
- 360K Floppy Drive
- AT Style Keyboard
- 150W Power Supply
- 256K RAM
- Expandable to 640K
- Monochrome Monitor
- Monographic Video Card
- Parallel Printer Port

FREE spreadsheet and word processor
3.XXMS DOS and GW Basic add \$75

Four-Function Frequency Counters



F-1000 1.2GH
\$259

F-100 120MH
\$179

- Frequency, Period, Totalize, Self Check with High Stabilized Crystal Oven Oscillator, 8 digit LED display

GF-8016 Function Generator with Freq. Counter



\$239

- Sine, Square, Triangle Pulse, Ramp, .2 to 2MHz
- Freq Counter .1 - 10MHz

GF-8015 without Freq. Meter \$179

WE WILL NOT BE UNDERSOLD!

UPS Shipping: US 5%

(\$10 Max) IL Res., 7% Tax



C & S SALES INC.

1245 Rosewood, Deerfield, IL 60015

(800) 292-7711 (312) 541-0710

15 Day Money Back Guarantee

2 Year Warranty

WRITE FOR FREE CATALOG

FIGURE 6

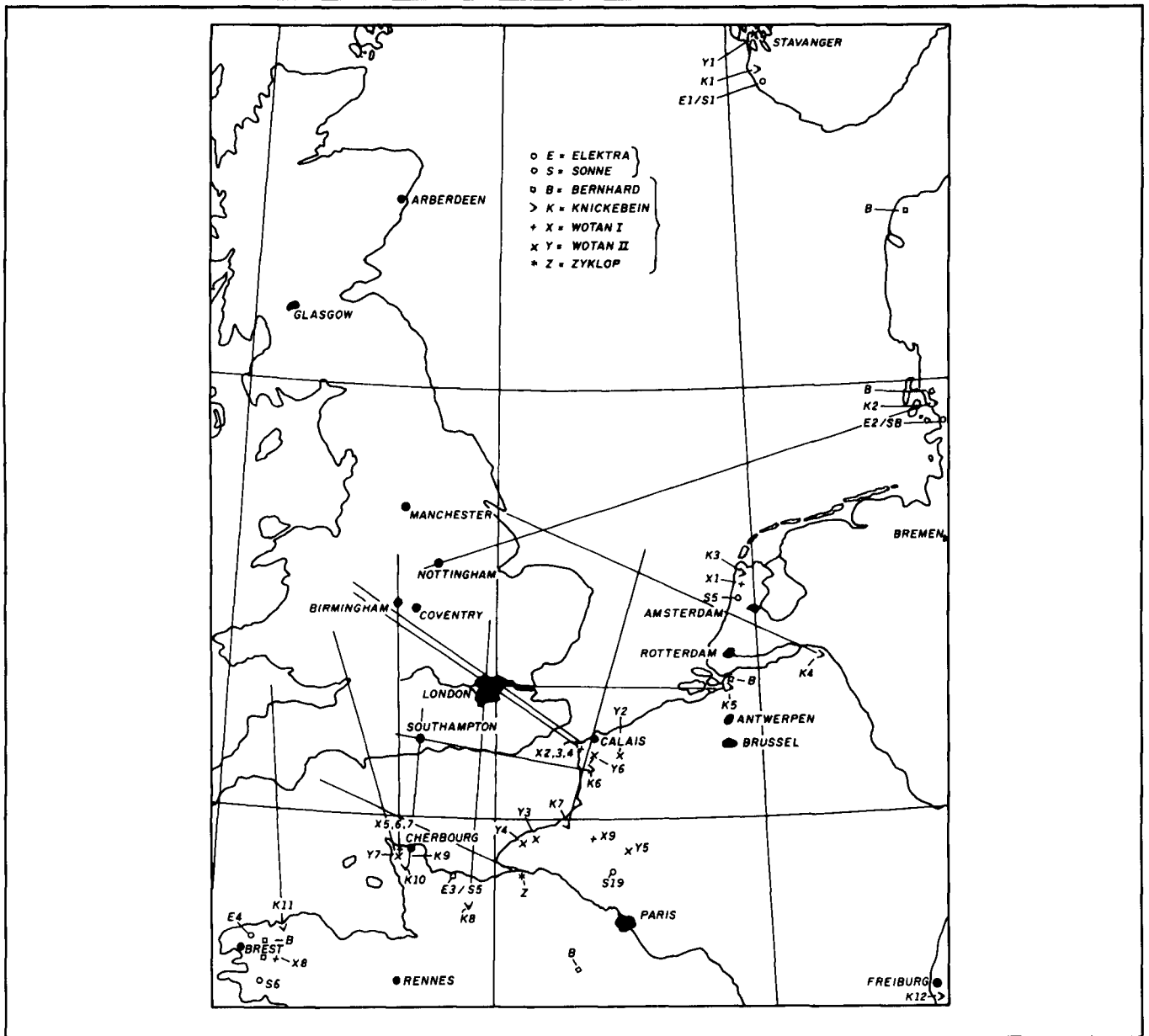

Official German layout showing the disposition of all beam systems in use at that time.

pulled out all the stops, and British Signals Intelligence (including Voluntary Interceptors — a body of dedicated Radio Amateurs) doubled their efforts. Their activities prompted Jones to record his appreciation: "Our community of Radio Amateurs in Britain was to prove an invaluable reserve, both in Signals Intelligence and Signals proper, as well as furnishing many of the staff for our rapidly increasing number of radar stations."

It was that well-known Amateur of his day, Rowley Scott-Farnie, G5GI, then an officer in RAF Signals Intelligence and a close friend of Jones, who reported beam signals from the Calais and Cherbourg areas around 70 MHz. By September 24, six beam stations were identified: two northwest of Cherbourg, three near Calais, and the last near Brest. The Germans had code named them *Weser*, *Spree*,

Rhein, *Elbe*, *Isar*, and *Oder*. Evidently Kampf-Gruppe 100 was working through a book of numbered targets, and by the time the stations were identified Jones had the actual directions for the beams — and even that the Germans had specified them to the nearest 5 seconds of arc, an accuracy of about 10 meters at 320 km! (See Figure 7).

But how could such an accuracy be possible on 70 MHz?

The "Anna" numbers

Further decoded German transmissions revealed the existence of coarse and fine beams, including a mention of centimeters. This latter, however, referred to the precision with which a monitoring vehicle had to be positioned to orientate the director beam. Frequent mention of something called "Anna" was made, usually associated with a num-

ber between 10 and 85, and often a multiple of 5. By October 17, Jones had collected 10, 15, 25, 30, 35, 44, 47, 55, 60, 75, and 85. Another set of numbers gave crystal frequencies (typically 8750 kHz, since $8750 \text{ kHz} \times 8 = 70 \text{ MHz}$) and he suspected that Anna referred to the dial on the aircraft receiver, if not the aircraft itself. Since one set of numbers ended in 0 or 5, and the other in 0 or 0.5, simple deduction showed that the Anna reading had to be divided by 10 and either added to, or subtracted from, a constant number.

Learning from the Enigma traffic that a certain Feldwebel Schumann at a beam station at den Helder had signed a return for 3 crystals for 69.5, 70, and 71.1 MHz and that his station was ordered to transmit on Anna numbers 30 and 35, it was clear that the constant had to be 66.5 if one-tenth of the Anna number had to be added, or 73 if it had to be subtracted. As he knew that crystals for 75 MHz existed, the second possibility could be dismissed; when he obtained further confirmation from the two crystals whose frequencies were not exact or half integers, the problem was solved. Other information that emerged from the Anna numbers was that both the coarse and fine beams lay between 66.5 and 75 MHz.

Measurement inaccuracy

The immense value of Anna numbers was that if the transmitted orders to the beam stations could be decoded in time, he could then tell 80 Wing the frequencies to be jammed. Incredibly, his interpretation of the numbers was rejected because our monitoring services thought there were frequencies outside the range he had found. Dr. Jones's hackles rose — a posture they were seldom slow in assuming — and plain words were spoken. *"These, it transpired, were due to bad measurement of the frequencies of the German beams on the part of the countermeasures organization, a feature that was to plague us through the whole battle. The fault in this case probably lay not with the observers, but with the calibration of our receivers which were not up to the German standard of precision."* His findings were accepted.

Dr. Robert Cockburn of the Telecommunications Research Establishment, having successfully prescribed "Aspirins" for the Knickerbein "Headaches," now developed "Bromides" for this new system which was code named "Ruffian." We now knew that the director beam was radiated from near Cherbourg and the cross-beams from the Calais area. As insurance against the failure of the main director beam (Weser), a reserve beam was provided by the adjacent station (Spree). The accuracy of the beams was so great that in calculating their paths it was necessary to take into account that the earth is not a sphere, but flattened towards the poles; this made a difference of 275 meters in where a beam from Cherbourg would cross London!

Countermeasures and counter arguments

Cockburn's jammers came into operation in October, but at this time Kampf-Gruppe 100 began to drop flares over its targets. This was hailed by some of Jones's antagonists as proof that the beams didn't work, or that the Germans were so unsure of them that they were using flares to find

FIGURE 7

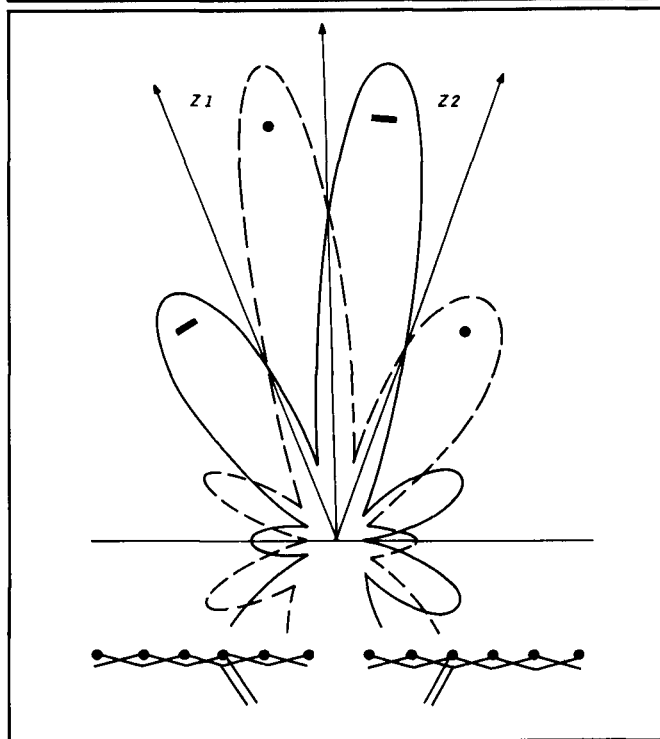

Beam patterns of mobile X-Gerät.

out where they were. However, Jones silenced these critics by pointing out that there was no evidence that Kampf-Gruppe 100 was upset by our countermeasures (which was true) and were not only using the system, but acting as pathfinders for other Luftwaffe groups.

Yet other problems had to be overcome.

If the Enigma transmissions to the beam stations (usually sent out in the afternoon preceding a raid) could be broken in time, we would know where and when Kampf-Gruppe 100 was going to attack, and our fighters could be ready for them. Our jammers, too, could be set on the correct frequencies. For this to be possible the cryptographers at Bletchley Park strained all their resources — and it was a magnificent effort, for they achieved this incredible feat late in October. Dr. Jones was then able to tell Fighter Command the exact place of the attack, the time of the first bomb to within 10 minutes, the exact speed of the bombers, their line of approach to within 90 meters, and their height to within two or three hundred meters!

Yet our night fighters repeatedly failed to find the enemy. Jones wrote: *"I almost began to wonder whether the only use the Duty Air Commodore made of my telephone calls was to take a bet with the rest of the Command as to where the target would be for that night."* On top of this was the growing suspicion that our jamming was not working. Why not?

The answer soon came, but not before tragedy struck.

Moonlight Sonata

On November 10 Jones received an Enigma decrypt of a transmission to the beam stations which told them to prepare operations against target numbers 51, 52, and 53, giv-

NYE

Takes the fear out of full power antenna tuners, and the guesswork out of PEP measurement with these two MUST SEE PRODUCTS!!

MB-V-A



Discover this durably built, feature packed MB-V-A Antenna tuner. You'll find operating conveniences that make antenna tuning a snap and value engineered to do the job over wide operating ranges. Compare quality, features and the NYE VIKING TWO YEAR WARRANTY.

RFM-003



Get correct easy to read measurements of PEP for SSB, AM, and Pulse along with full time completely automatic SWR display with this unique Power Monitor System. Two models to choose from: The RFM-003 for 3KW indication and The RFM-005 for 5KW.

CHECK THE FEATURES:

- **Pi Network.** Low Pass Pi Network tuning 1.8-30 MHz. Heavy duty silver plated continuously variable inductor with 25:1 vernier dial, 7000 volt variable capacitor and 10,000v switch selected fixed capacitors on output side. Tunes 40-2000 ohms loads. Good Harmonic suppression!
- **Automatic SWR.** Hands free metering of SWR. No reset or calibration needed. Separate power meter—300 or 3000 w f.s. automatically switched. Easy to read 2.5" recessed and back-lighted taut band meters.
- **Antenna Switch.** PUSH-BUTTON antenna switching to (4) antennas (2 coax, single wire and twin lead). Coax bypassed on first coax output. We designed this switch to take the power. Rated at 10KV and 20 amps.
- **3 KW Balun.** Trifler wound triple core torroid gives balanced output to twin feeder from 200 to 1000 ohms and unbalanced output down to 20 ohms.
- **Maximum Power Transfer.** Match your transmitter output impedance to almost any antenna system for maximum power transfer. Amplifiers only run at their designed Q when properly matched.
- **Model Options.** MB-IV-A1 includes all MB-V-A features less antenna switch and balun. MB-IV-A2 is identical to MB-IV-A1 with the addition of a triple core balun.
- **1.8 MHz** will not tune on some antennas.
- **(3) Modes** — Peak Average and Peak and Hold with a unique non-drift Sample & Hold Analog memory circuit.
- **(2) Ranges** — Automatically switched power scales to 5 KW.
- **Fully Automatic SWR** — Full time meter displays ratios directly without drift.
- **Built-in ALD** — Protect your amplifier tube investment with this fast acting lockout.
- **Remote Couplers** — Six feet remotes the interchangeable calibrated couplers.
- **True RMS Conversion** — H.F. couplers use forward biased full wave detection.
- **Rugged Construction** — Heavy gauge aluminum construction. Top quality glass epoxy PCB. This meter is built to last.
- **Accuracy** — Guaranteed to $\pm 5\%$ F.S.
- **Warranty** — TWO FULL YEARS.
- **Added Features** — Switchable reverse power all mode metering — Full status LED Display — Adjustable ALO is switchable SWR/REFL power — Heavy duty Nicad batteries charged by the applied RF for the field and a charger is supplied for fast charging and backlighting of the taut band meters for the ham shack.

OTHER NYE VIKING PRODUCTS

Phone Patches — Electronic and Memory Keyers — Squeeze Keys — Straight Keys — Code Practice Sets — SWR Wattmeter for the blind — Low Pass Filters — All Band Antennas and more . . .
ASK FOR A FREE FULL LINE CATALOG.

TO ORDER, CALL YOUR FAVORITE DEALER

Amateur Electronic Supply
Ham Radio Outlet
Henry Radio
Madison Electronics
EGE
R&L Electronics
rf enterprises
Barry Electronics

C-Comm
Ross Distributing
Quement Electronics
LaCue Communications
Ham Station

In Europe: Kneisner & Doering,
Braunschweig, W-Germany



Wm. M. Nye Co. Inc.
1614 130th Ave. N.E.
Bellevue, WA 98005
TEL: (206) 454-4524
FAX: (206) 453-5704

- Lowest NF GaAs FET Preamp
- Finest Quality Military Construction
- Off-The-Shelf Dealer Delivery



For the past five years, Amateurs worldwide have sought quality amplifier products from TE Systems. Renowned for the incorporation of high quality, low-noise GaAs FET preamplifiers in RF power amplifiers, TE Systems offers our fine line of products through select national distributors.

All amplifiers are linear (all-mode), automatic T/R switching with adjustable delay and usable with drive levels as low as 1/2 Watt. We incorporate thermal shutdown protection and have remote control capability. All units are designed to ICAS ratings and meet FCC part 97 regulations. Approx. size is 2.8 x 5.8 x 10.5" and weight is 5 lbs.

Consult your local dealer or send directly for further product information.

TE SYSTEMS
P.O. Box 25845
Los Angeles, CA 90025
(213) 478-0591

SPECIFICATIONS

Model	Freq. MHz	Power Input	Power Output	Preamp NF-dB	Preamp Gain-dB	DC +Vdc	Power A	RF Conn.
0508G	50-54	1	170	.6	15	13.6	28	UHF
0510G	50-54	10	170	.6	15	13.6	25	UHF
NEW! 1409G	144-148	2	160	.6	15	13.6	25	UHF
1410G	144-148	10	160	.6	15	13.6	25	UHF
1412G	144-148	30	160	.6	15	13.6	20	UHF
2210G	220-225	10	130	.7	12	13.6	21	UHF
2212G	220-225	30	130	.7	12	13.6	16	UHF
4410G	420-450	10	100	1.1	12	13.6	19	N
4412G	420-450	30	100	1.1	12	13.6	19	N

Models also available without GaAs FET preamp (delete G suffix on model #). All units cover full amateur band - specify 10 MHz bandwidth for 420-450 MHz amplifier.

Amplifier capabilities: 100-200 MHz, 225-400 MHz, 1-2 GHz, Military (28V), Commercial, etc. also available - consult factory.

Engineering Consulting's computer controlled Ham Shack See system variables, control & reprogram all via packet! **Ultra Comshack 64 Repeater Controller** HF & VHF Remote Base* Autopatch* CW Practice* Rotor Control *Voice Meters* Paging* Logging* Polite ID's* Packet Voice B.B.S.

Model CS64S \$359.95
Includes: Interface, disk, cables, Manual
Ultra Options

FT 757, 767, 960, 736, 747
TS 440, 940, 140
IC 735, 761
FT 727R, 767, 736
TS 711, 811, 680

Controller Features
*Change variables remotely from touchtones or Packet
*Unlimited voice vocabulary!
*Alarm Clock, auto execute
*Individual 4 digit user codes
*Disk & Printer logging of users, tel #'s, lapsed time
*18 Rotating Polite ID's
*16 External relay controls
*2-tone & sub tone Paging
*CW Practice with voice
*Security mode, T.tone mute
*Voice announces each user call sign when logging on

Autopatch & Reverse
*1000 (18 digit) tel #'s stored
*Quick dial & quick answer
*Directed, general page
*Selected restricted patch
*Telephone control input
Dual Combined Remotes
*18 Macro/Scan memories
*Scan up/down; 100Hz steps
*Monitor & lock modes
*Operate splits, combine HF & VHF radios as Dual VFO's
*Automatic mode selection
*Talking S Meter; Voltmeter
*Voice Beacon rotating msg

NEW! Add Duplex Remote Base operation & monitor mode from any telephone.....TLCN.....\$159.95
External relays: 3 DPDT relays +5
Open Col. Trans. Sw...CS 8...\$89.95
*Rotor control D.C. to digital display & Voice; for all rotors...HM1...\$59.95
*Packet & BBS; Voice Meters & Alarm Inputs; 8 On/Off. PK8...\$159.95
*Slave Packet interface & cable Links PK8 to 2nd C64...PK1...\$89.95
*EPROM Autoboot CART, custom with your system.....CART...\$109.95
*C64 & 1541 12V. Switching supply crystal controlled...DCPS...\$129.95
*Manual (REFUNDED) MN1...\$20.00

Computer Control YAESU FT-727R Mini Cat
Allows H.T. to scan 100 Channels & programs
H.T. for field use! Digital "S" Meter; comment fields; auto resume & delay; Scan Lock-outs; Loads FT727 in 15 sec. Hardware, cables, & disk included for C64 or IBM
Model 727 \$49.95

Touchtone Decoder
4 digit sequence; & QUAD expansion 4 relay option
2"x3" TSQO
8/20 V & audio in; Field Program 50,000 Codes; Mom. & Latching; DPDT Relay; Wrong digit reset; LED for digit valid & latch; inc. 24 Pin connector
QUAD option adds: four 2 Amp. relays; 5 digit master on/off control for each relay.
TSQO \$89.95 QUAD \$99.95

Decode-A-Pad
Touchtone to RS232 300 Baud Interface
Use with all computers
Decodes 16 touchtones
Includes Basic program
DAP \$99.95

12 Volt C64 SWITCHER
Crystal 60Hz
9VAC 5V. 2A.
C64 & 1541
DCPS \$129.95

AUDIO BLASTER IC02;04;2AT;FT-727R
411;209;470;73;23;U16
←Miniature Audio Amp.
Module installs inside all H.T.'s
1 watt audio amp! When it needs to be loud! Installs in 15 Min. Used by police, fire!
Model AB1S \$24.95

New C64 "Packet Talker"
Stores messages on disk for up to 300 users; touchtone commands recall & speak your stored messages on repeater or packet freq. Works with all Packet TNC's; Converts all packet messages to VOICE!
Inc. disk & Interface **PKTA \$189.95**

ENGINEERING CONSULTING
583 CANDLEWOOD ST.
BREA, CA. 92621
TELEPHONE: 714-671-2009
FAX: 714-255-9984

We accept: C.O.D.'s
MasterCard, VISA, Disc
American Express
add \$3.00 S/H U.S.A.
Ca. residents add 6%

Make the most of your general coverage transceiver with **Monitoring Times!**

Every month Monitoring Times brings everything you need to make the most of your general coverage transceiver: the latest information on international broadcasting schedules, frequency listings, international DX reports, propagation charts, and tips on how to hear the rare stations. Monitoring Times also keeps you up to date on government, military, police and fire networks, as well as tips on monitoring everything from air-to-ground and ship-to-shore signals to radioteletype, facsimile and space communications.

ORDER YOUR SUBSCRIPTION TODAY before another issue goes by. In the U.S., 1 year, \$18; foreign and Canada, 1 year, \$26. For a sample issue, send \$2 (foreign, send 5 IRCs). For MC/VISA orders (\$15 minimum), call 1-704-837-9200.

MONITORING TIMES
Your authoritative source,
every month.
P.O. Box 98 A
Brasstown, N.C. 28902

ing the beam settings at the same time. It took only a few minutes to work out that 51 was Wolverhampton, 52 was Birmingham, and 53 was Coventry. Then another signal was passed to him which contained orders for a major operation under the code name *Moonlight Sonata*. Four target areas were mentioned but there was no indication of the order of the attacks. Frantic guesses were made by the Air Staff and the best they could come up with was that Moonlight Sonata might mean a target in southern England. Strangely, no attack had been made on Wolverhampton, and on November 14 everyone braced themselves for the coming night and whatever Moonlight Sonata might mean.

Tragically, it was one of those afternoons when Bletchley Park failed to break the Enigma signals in time, and 80 Wing asked Jones which frequencies they should set their jammers on, giving a list of frequencies as determined by our monitoring aircraft. *"I could see at once that the measurements must be wrong, in that they did not match up with the figures I knew from the Anna code. I therefore made a mental correction of the measurements as far as I could. For example, 68.6 should have been 68.5, if our receivers had been properly calibrated, or 70.9 should have been 71.0. But deciding what, for example, 66.8 meant was more of a lottery. The only other clue that I spotted was that there seemed to be a convention that the director beams would generally be on frequencies between 66.5 and 71.5 and the cross-beams between 71.5 and 75 MHz — the division being presumably due to operational convenience. Remembering that we needed to knock out the main and reserve director beams and at least one of the cross-beams, I then made my mental gamble and suggested a set of frequencies to Addison which he said he would adopt. All this took no more than five minutes on the telephone, but I was well aware that in these snap decisions I was probably gambling with hundreds of lives. Sobering though this thought was, the fact remained that someone had to do it, and I was easily in the best position."*

Then on the night of November 14th Coventry was attacked, with heavy civilian casualties. What had gone wrong? The next day the decoded Enigma signals to the beams stations arrived and Jones's wretchedness turned to bewilderment. He had guessed the frequencies correctly — so where was the failure?

Incompetence and carelessness

The failure arose originally from a silly interservice squabble which led on to a ghastly mistake. On November 6 one of Kampf-Gruppe 100's Heinkels became lost over southern England and ditched on Chesil Beach. The Army took over, secured a rope around the fuselage and set about salvaging it, when a naval inshore vessel arrived and demanded to know what the Army thought it was doing. As the aircraft was in the water, salvage was a Navy matter, and taking the rope aboard they dragged the aircraft deeper into the sea, breaking the rope in the process. The X-Gerät equipment aboard, now heavy with silt and corrosion, was fortunately discovered and rushed to 80 Wing and then on to Farnborough for investigation.

On November 21 Jones, accompanied by Scott-Farnie and their assistants, went to see it for themselves. They learned that Farnborough had examined the audio filter and

found it set to 2000 Hz. But our jammers had been modulated at 1500 Hz, which meant that while our carrier frequencies were correct the modulation tone had no effect on the beams.

"It was one of those instances, of which I have since found many, where enormous trouble is taken to get the difficult parts right and then a slip-up occurs because of lack of attention to a seemingly trivial detail. Of all the measurements in connection with the German beams, easily the simplest to determine was the modulation note, because this could be done at any time in comfort; and yet whoever had done it had either been tone deaf or completely careless, and no one had ever thought of checking his measurements. I was so indignant that I said whoever had made such a mistake ought to have been shot." It is hard to believe that the citizens of Coventry would have disagreed with this opinion.

Jones's anger was further increased by the fobbing-off he encountered. He was told that the modulation note was originally 1500 Hz but the Germans had changed their filters to avoid jamming. This ridiculous excuse was countered by Jones who pointed out that if that had been the case he would obviously have heard the change in note for ourselves. In any event he was able to prove that Kampf-Gruppe 100 had been using the same filters since the start of their operations.

On his insistence the jamming modulation frequency was changed and when the Germans later attacked Birmingham their bombs fell wide of the target, most of them outside the city. Gradually they came to realize we had broken X-Gerät and their confidence in the system diminished, and Britain which knew nothing about Dr. Jones and his scientific war went on with "business as usual."⁷⁷

Reprinted with permission from *Practical Wireless*, PW Publishing Ltd., February 1988. Ed.



**GREAT
GIFT
IDEA**

HAM RADIO LOG BOOKS

back by popular demand!

Room for over 2100 QSO—that's over twice as many as the other log books. For contesters, each page contains 30 QSO's for easy counts. You also get the latest up-to-date frequency spectrum chart. ITU callsign list and ARRL DXCC list. Spiral bound to lay flat on your desk. Unquestionably the best log book value around. © 1988.

HR-LB.....Spiralbound \$2.95
HR-3LB Special Buy 3
Save 22%.....Get 3 \$6.95



Please add \$3.75 for shipping and handling.



**HAM
RADIO**
GREENVILLE, NH 03048

BOOKSTORE
(603) 878-1441

VERSATILE TRANSISTOR/DIODE TESTER

By Jim Owens, W5JQE, 20594 CR-150, Flint, Texas 75762 with G. D. Hanchett, W2YM

This simple and inexpensive transistor/diode tester shows shorts, opens, leakage, saturation and junction voltage, and relative gain or DC beta. It works on NPN and PNP bipolars, Darlington pairs, signal and power diodes, and FETs with junction or insulated gates in *n*- or *p*-channel, depletion or enhancement types. The tester also lets you solder and unsolder delicate FETs in chassis safely, using an ordinary ungrounded soldering iron. In the circuit diagram (shown in the off position) in **Figure 1** note that the RED (+), the RED (-), and the black base/gate (BG) leads are all connected together. You simply connect the micro clips to the transistor terminal wires in the following order: (-) to source, (+) to drain, and one or both of the (BG) clips to the gate terminal(s), and solder. Reverse the order when disconnecting the clip leads. Incidentally, all designators shown in parentheses — (+) and (-) and (BG), for example — conform to markings on the front panel and in the circuit diagram.

To understand how the tester works, set ganged switch S1-3 to the bipolar position (BP). Now trace the current path from the positive end of the AAA cells through CR1, CR2, R2, S1, R4, R5, the meter, R6, CR3, CR4, and S3 to the negative end of the AAA cells. The current drain of the R1 (BIAS) control on the batteries and the loading effect of the meter with its multipliers, along with R8 and R9, produce a voltage drop across the four diodes and the two 1000-ohm load resistors. This voltage drop lets you adjust R4 for 200 μ A which registers full-scale deflection on the meter. The actual voltage between the RED (+) lead and the RED (-) lead will be approximately 2 volts. Note the (READ 2 VOLTS) label on the front panel of the tester.

The current drawn by the semiconductor device increases the voltage drop in the tester circuit, so the meter reads the voltage across the device instead of the current through it. This makes the tester versatile, easy to build, and reliable.

Testing procedures

Try testing an NPN bipolar transistor. Set the S1-3 switch to (BP) and the (BIAS) control to its (-) end. Connect the test clips as follows: RED (-) to the emitter, RED (+) to the collector, and one of the (BG) clips to the base. The meter should read full scale, 2 volts, because the transistor is biased beyond cutoff. Now advance the (BIAS) control toward its (+) end. At some point the transistor will start to conduct; this will increase the voltage drop across R2 and R6, and lower the meter reading. At or before full drive, the meter should read 0.1 or 0.2 volt. It will be drawing about 2 mA and reading the saturation voltage of the transistor under the test conditions. This reading indicates a good transistor. A shorted transistor will read zero; an open transistor will read full scale. The (BIAS) control has no effect on either reading.

The test for a Darlington NPN is the same as for the regular bipolar, but there will be a difference in the meter reading. The Darlington saturates at about 0.5 volt. Transistors are somewhat bidirectional. They conduct and amplify in both directions, but have much lower gain in the wrong direction. So test any unknown unit in both directions.

How do you tell an NPN from a PNP? Picture a bipolar transistor as two diodes in series. An NPN has its diodes back-to-back, arrows pointing outward. If you connect the (+) clip to the base and the (-) clip to the emitter or collector, there will be conduction with a drop in the meter reading. Conversely, a PNP has its diodes connected face-to-face, arrows pointing inward. So when you connect the (-) to the base and the (+) to the emitter or collector, there will be conductivity and a drop in the meter reading. However, if you connect the test clips to a PNP as an NPN, or vice versa, there will be little or no conduction and the meter will remain at or near full scale.

The test for a PNP bipolar is the same as for an NPN, except that the RED (+) clip goes to the emitter and the RED (-) clip to the collector. The rotation of the (BIAS) control is reversed.

KENWOOD

...pacesetter in Amateur Radio

Affordable
Breakthrough!

Dual Band Afford-ability!

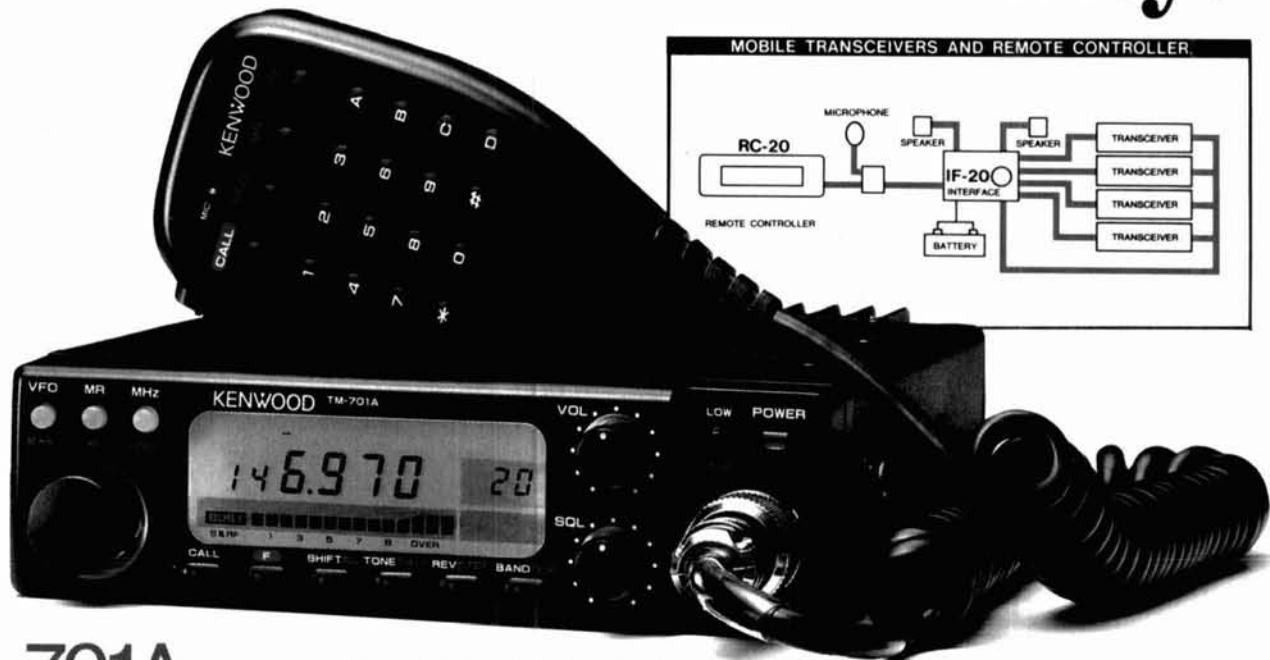

TM-701A

Dual Bander

The TM-701A combines two radios into one compact package. You get 25 watts on 2 meters and 70cm, 20 memory channels, tone encoder built-in, multiple scanning, auto repeater offset selection on 2 meters, and a host of additional features!

- **20 multi-function memory channels.** 20 memory channels allow storage of frequency, repeater offset, CTCSS frequency, frequency step, and Tone On/Off status, CTCSS and REV, providing quick and easy access during mobile operation.
- **25W on 2m and 70cm.**
- **Selectable full duplex-cross band (Telephone style) operation.**
- **Easy-to-operate front panel layout.**
- **Multi-function DTMF mic. supplied.** Controls are provided on the microphone for CALL (Call Channel), VFO, MR (Memory Call or to change the memory channel) and a programmable function key. The programmable key can be used to control one of the following functions on the radio: MHz, T. ALT, TONE, REV, BAND, or LOW power.
- **Easy-to-operate illuminated keys.** A functionally designed control panel with individually backlit keys increases the convenience and ease of operation during night-time use.

- **Optional full-function remote controller (RC-20).**

A full-function remote controller using the Kenwood bus line may be easily connected to the TM-701A and mounted in any convenient location. The new controller is capable of operating all front panel functions.

- **Built-in dual digital VFO's.**

a) **Frequency step selection (5, 10, 15, 20, 12.5, 25kHz)**

b) **Programmable VFO**

The user friendly programmable VFOs allow the operator to select and program variable tuning ranges in 1 MHz band increments.

- **Programmable call channel function.** The call channel key allows instant recall of your most commonly used frequency data.

- **Programmable tone encoder built-in.**

- **Tone alert system—for true quiet monitoring.**

When activated this function will cause a distinct beeper tone to be emitted from the transceiver for approximately 10 seconds to signal the presence of an incoming signal.

- **Easy-to-operate multi-mode scanning.**

a) **VFO scan**

Band scan, Programmable band scan.

b) **Memory scan plus programmable memory channel lock-out**

c) **Dual scan**

Dual call channel scan
Dual memory scan
Dual VFO scan

d) **Scan stop modes**

Time operated scan (TO)
Carrier operated scan (CO)

e) **Scan direction**
f) **Alert**

When the AL switch is depressed memory channel 1 is scanned for activity at approximately 5 second intervals.

- **MHz switch.**
- **Lock function.**
- **Repeater reverse switch.**

Optional Accessories

- **RC-20** Full-function remote controller
- **RC-10** Multi-function remote controller
- **IF-20** Interface unit handset
- **MC-44** Multi-function hand mic.
- **MC-44DM** Multi-function hand mic. with auto-patch
- **MC-48B** 16-key DTMF hand mic.
- **MC-55** 8-pin mobile mic.
- **MC-60A/80/85** Desk-top mics.
- **MA-700** Dual band (2m/70cm) mobile antenna (mount not supplied)
- **SP-41** Compact mobile speaker
- **SP-50B** Mobile speaker
- **PS-430** Power supply
- **PS-50** Heavy-duty power supply
- **MB-201** Mobile mount
- **PG-2N** Power cable
- **PG-3B** DC line noise filter
- **PG-4H** Interface connecting cable
- **PG-4J** Extension cable kit
- **TSU-6** CTCSS unit

KENWOOD

KENWOOD U.S.A. CORPORATION
COMMUNICATIONS & TEST EQUIPMENT GROUP
P.O. BOX 22745, 2201 E. Dominguez Street
Long Beach, CA 90801-5745
KENWOOD ELECTRONICS CANADA INC.
P.O. BOX 1075, 959 Gana Court
Mississauga, Ontario, Canada L4T 4C2

PLUG INTO PACKET!

Simple and Easy.

Here's the easiest packet radio yet, you don't even have to buy a TNC to join the digital revolution. Just let your PC do the work. Plug a PC Packet Adapter into any expansion slot and get on the air in minutes, just like an expert. And you'll still be able to use the PC for other work! The complete VHF system is only \$139.95!

Sophisticated, Too.

When you've mastered the basics, use the PC*Packet Adapter for simultaneous dual-band HF/VHF, multiconnect, BBS, TCP/IP, DXer's PacketCluster, 2400 baud (and higher). Even use the Developer's Package to write your own packet application.

Software Included.

Unlike others, DRSI includes all the software you need. The THS terminal package has split screen, file save/send, binary file transfer, print, scroll, review and more.

2400 BAUD

Many areas are upgrading their packet nets to this higher speed. DRSI's M-24 modem for 2400 baud connects simply with no modifications to your rig and lets you operate both 1200 and 2400 simultaneously with your present radio. Step up to this new speed for just \$79.95, today!

**Call or Write
for complete
Product Catalog**

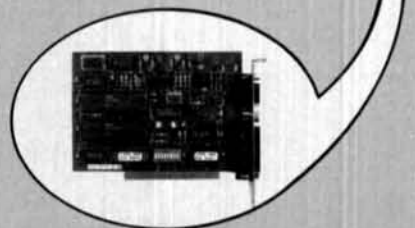

DRSI

2065 Range Road
Clearwater, FL 34625
ORDERS: 1-800-999-0204

✓ 120

Kenwood TH-75A



The **Kenwood TH-75A** dual band HT features 2 m and 70 cm in one compact package. Dual LCD display, full duplex operation, tone alert, ten multifunction memories, multi mode scanning plus many more features. Comes with antenna, PB-6 nicad and charger.

Only \$469.99 (+\$5 UPS)

Order #HR-2179

➔ **EXTRA PB-6 Battery only \$19.99**
with purchase of TH-75A.

Limit one per purchase while supply lasts.

Informative Catalogs

AMATEUR CATALOG
This 48 page catalog covers all major lines of ham gear including Kenwood, Icom, Yaesu, AEA, Kantronics, and Hustler. With prices!
Only \$1 Postpaid

SHORTWAVE CATALOG
52 pages of everything that is new for the SWL, including receivers, portables, antennas, RTTY & FAX decoders, books and accessories.
Only \$1 Postpaid

Universal Radio

1280 Aida Drive Dept. HR
Reynoldsburg, OH 43068
Toll Free: 800 431-3939
In Ohio: 614 866-4267

Universal has been serving the ham community since 1942. We are an authorized dealer and service center for Kenwood, Icom and Yaesu.

WHAT'S THE BIGGEST ISSUE IN HAM TV TODAY?

THE NEXT ISSUE OF AMATEUR TELEVISION QUARTERLY

- ACCURATE reporting
- TECHNICAL information
- VALUABLE content
- QUALITY production

SUBSCRIPTIONS:

1 Year \$15 U.S., \$20 Canada, \$25 Elsewhere

1545 Lee Street, Suite 73
Des Plaines, Illinois 60018
(312) 298-2269

FIGURE 1

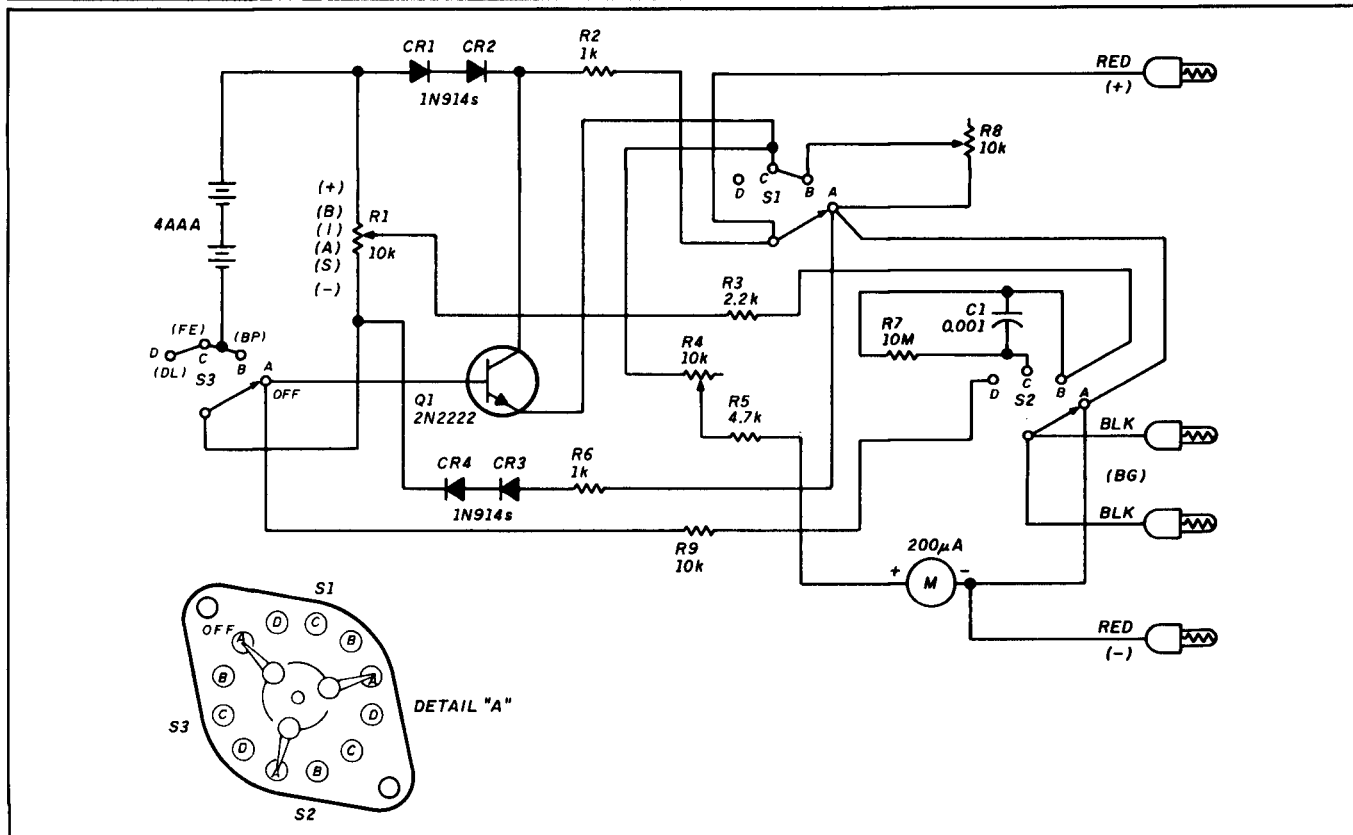

Schematic diagram of the diode/transistor tester.

PARTS LIST

CAPACITORS

C1 0.001 ceramic

RESISTORS

R4, R8 10-k potentiometer (RS 271-335)
 R2, R6 1 k
 R3 2.2 k
 R5 4.7 k
 R7 10 meg
 R9 10 k
 R1 10-k potentiometer (RS 271-1715)

SEMICONDUCTORS

CR1-4 1N914
 Q1 2N2222 (RS 276-2009)

MISCELLANEOUS

Meter (no. 20-907 Circuit Specialists)
 Case (RS 270-222)
 Knobs (RS 274-403)
 Test leads (RS 278-016 cut in half to provide four leads)
 S1-3 four-position triple-gang switch (10YX034 Circuit Specialists)

Possible parts suppliers

Circuit Specialists, Box 3047, Scottsdale, Arizona 85257
 Mouser Electronics, Box 699, Mansfield, Texas 76065
 DC Electronics, Box 3202, Scottsdale, Arizona 85257
 Madison Electronic Supply, 3621 Fannin, Houston, Texas 77004

Test all bipolar transistors for leakage in the same manner. Remove the (BG) clip from the base following the saturation test, allowing the unit to self-bias beyond cutoff. If there's no collector-to-base leakage, the meter immediately rises to full scale. You can expect germanium units to show some leakage — the meter won't rise all the way to full scale. However, these units may still operate satisfactorily in circuits designed for them.

Selecting matched pairs is easy. Test the first one with the (BIAS) control set for a reading a little above the saturation voltage. Then try others; don't move the (BIAS) control. Choose the two with the nearest to identical readings.

Testing J-FETs and MOSFETs

Test field-effect transistors as you would bipolars, but place the S1-3 switch in the (FE) position. This puts a 10-meg resistor in series with the gate. Try a junction gate for your first test. Connect the RED (-) to source, the RED (+) to drain, and one of the (BG) leads to the gate. Rotate the (BIAS) control from cutoff to saturation. As with a bipolar, this occurs at about 0.1 or 0.2 volt. However, if you drive the gate into conduction, the voltage at the source will drop to near zero. To test for leakage, readjust the (BIAS) control for a mid-scale reading and then switch from (FE) to (BP). There will be no change in the reading if there's no leakage. Next, test a dual gate FET like the 40673. Connect the RED (-) clip to the source substrate terminal, the RED (+) clip to the drain terminal, and the (BG) clips to the gate terminals. It will saturate at the same level as the junction FET. Use the same test for leakage. Follow the same procedure for testing a single gate, but expect the saturation voltage to be double that of the dual gate.

coaxial R. F. antenna switches

**Heavy Duty switch for true
1 Kw POWER – 2 Kw P.E.P.
Ceramic with Coin Silver
Switch Contacts**

#CS-3G



Single Pole, 3 Position.
Desk or wall mount
All unused positions grounded

#CS-3G – UHF connectors / \$36.50*
#CS-3G-BNC – BNC connectors / \$43.95*

#CS-6G



Single Pole, 5 Position.
All unused positions grounded

#CS-6G – UHF connectors / \$46.50*
#CS-6G-BNC – BNC connectors / \$59.50*

*Shipping and handling for any
item add \$2 each.

ALL OUR PRODUCTS MADE IN USA



BARKER & WILLIAMSON

Quality Communication Products Since 1932
At your Distributors write or call
10 Canal Street, Bristol PA 19007
(215) 788-5581



W6SAI BOOKS

published by Bill Orr, W6SAI and Stu Cowan, W2LX

BEAM ANTENNA HANDBOOK

Completely revised and updated with the latest computer generated information on BEAM Antenna design. Covers HF and Yagis and 10, 18 and 24 MHz WARC bands. Everything you need to know. 204 illustrations, 268 pages. ©1985. Revised 1st edition.
□RP-BA **Softbound \$11.95**

ALL ABOUT VERTICAL ANTENNAS

Theory, design, construction, operation—are fully covered. Here's what this exciting book covers: Horizontal vrs vertical—which is best? Top loaded and helical antennas, 5 high efficiency Marconi antennas for 80 and 160, verticals and TVI—Is there a problem? The effects of ground on vertical antennas and a how to make an effective ground system, the Bobtail beam, construction data for 25 different antennas, matching circuits of all descriptions—which is best, plus P-L-E-N-T-Y more! 1st edition, 192 pages © 1986

□RP-VA **Softbound \$10.95**

RADIO HANDBOOK 23rd Edition

Here are some of the highlights of this exciting new edition: New easy-to-use charts for Chebyshev and elliptic filter configurations, new data on power MOS-FETS, how to use state-of-the-art OP-AMPS, and home computer RTTY to name just a few examples. New projects include: GaAsFET preamps for 902 and 1296 MHz, easy-to-build audio CW filter, Economy two 3-500Z, 160 meter amplifier, multiband amp using two 3CX800A7's, and a deluxe amplifier with the 3CX1200A7 tube. New antenna projects include: efficient Marconi design for 160 and 80 meters, computer generated dimensions for HF-Yagis, and a 2 meter slot beam. Get your copy today. 23 edition © 1986

□22424 (Reg. \$29.95) **Hardbound \$26.95**

THE RADIO AMATEUR ANTENNA HANDBOOK

A wealth of projects that covers verticals, long wires, beams as well as plenty of other interesting designs. It includes an honest judgement of gain figures, how to site your antenna for the best performance, a look at the Yagi-Quad controversy, baluns, slopers, and delta loops. Practical antenna projects that work! 190 pages. ©1978. 1st edition.

□RP-AH **Softbound \$11.95**

Please enclose \$3.75 for shipping and handling.

**HAM
RADIO**

GREENVILLE, NH 03048

BOOKSTORE

(603) 878-1441

PHOTO A

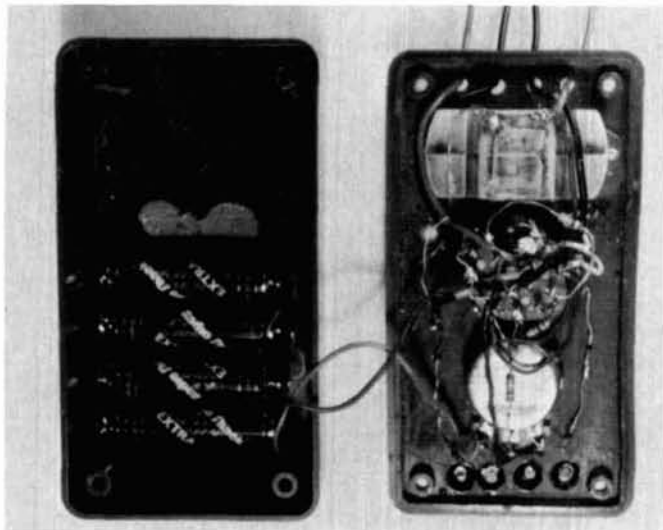

Inside view of the tester.

PHOTO B

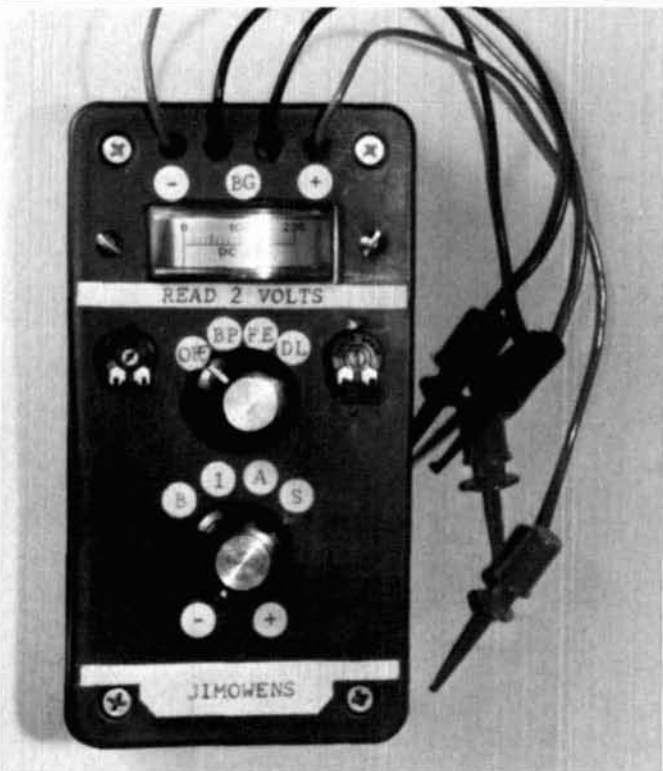

Completed tester, front panel view.

Diodes and rectifiers

Semiconductor manufacturers test diodes and rectifiers for forward bias voltage drop (a measure of junction voltage). In the shop or shack, junction voltage is the best indicator of the character of any diode. This measurement is easy to make. Put switch S1-3 in the (BP) position, then connect (+) to anode and (-) to cathode. A zero reading indicates a short; a full-

SATELLITE ESSENTIALS

Satellite TV is still full of the wonderment that made it so popular in the early '80s. The tinkerers are there, the programming is there, and never has the cost of becoming a dish owner been so low.

So, how do you find out about this exciting entertainment?

Through publications devoted specifically to satellite TV, that's how!

OnSat

America's Weekly Guide To Satellite TV

OnSat is unsurpassed for the most up-to-date listings of satellite programming. Dr. Dish, Mailbag, and the Transponder Service Watch are all geared to help you make the best use of your satellite TV system. A sample issue can be obtained for only \$1.

STV GUIDE

The Complete Monthly Guide To Satellite TV

STV Guide contains over 300 pages of programming information, product reviews, home troubleshooting, and information about satellite TV. A sample issue can be obtained for only \$2.

Both OnSat and STV Guide contain listings for over 120 channels and Prime Time Grids for over 50 channels. Subscribe to either the weekly OnSat or the monthly STV Guide for only \$48 per year.

To start receiving the best in satellite TV guides and information, call toll-free (800) 234-0021. VISA® and MasterCard® accepted.

STV Guide/OnSat
PO Box 2384 • Shelby, NC 28151-2384

ARE COMMUNICATIONS

Add HF To Your IC-R7000



With ARE's New — "2 in 1" Kit EXCLUSIVE TO ARE COMMUNICATIONS

500Hz to 2GHz CONTINUOUS receive in one unit. Using the ICR7000 multimode receiver, this kit makes the "2 in 1" ICR7000HF Receiver the most versatile scanner available today. Because of the enormous frequency coverage, the ICR7000HF has 200 mode sensitive channels for increased flexibility.

With excellent strong handling characteristics, using a direct fed Double Balance Mixer, the need for a pre-amp is unnecessary.

Available from stock, the new ICR7000HF kit. Complete with installation instructions.

Only \$149.00 including shipping.

Phone London 0044 1 997 4476 or
fax 0044 1 991 2565, quoting your credit card
number (Master Card/VISA/American Express)
and shipping details for immediate attention.

DEALER INQUIRIES WELCOME



ARE

Communications Limited, 6 Royal Parade,
Hanger Lane, Ealing, London W5A 1ET, England

Fax 44-01-991-2565

Tel 44-01-997-4476

scale reading indicates an open. Silicons read approximately 0.6 volt and germaniums read approximately 0.3 volt. Find matched pairs by selecting units with near identical junction voltage. Junction voltage is a more reliable figure of merit than the common ohmmeter resistance reading, in which one scale belies another.

Semiconductor manufacturers specify reverse bias diode leakage in microamperes. Hams talk about it in terms of kilohms or megohms, because we have only our ohmmeters to assess it. Actually, the resistance measurements correlate quite well if they are made above the voltage or current knee. To perform the test, set switch S1-3 in the (DL) position, connect the (+) clip to the cathode, and one of the (BG) leads to the anode. Germanium diodes have reverse bias leakage resistances ranging from thousands to millions of ohms. The usual range for rejection or acceptance lies between these extremes. This calls for a nonlinear meter scale, expanded on the high end and compressed on the low end, with a midpoint of about 500 kilohms. Exact readings aren't important; a point-to-point table will do. (You can glue it to one side of the instrument case.) The following is a tabulation of scale readings versus resistance values which I made for the model.

- 200 = zero ohms = full scale
- 150 = 180 k = 3/4 scale
- 100 = 560 k = 1/2 scale
- 50 = 1 meg = 1/4 scale
- 0.05 = 20 meg = no movement

The high resistance point at half division is useful mostly for checking silicon diodes. Silicon diodes are rated at near-infinite resistance; any unit that barely moves the meter is technically a reject. Compare that with a germanium 1N34 which is acceptable with a leakage resistance as low as 100,000 ohms.

In-circuit testing

It is important that an in-circuit tester be nondestructive. With this in mind, I like to use out-of-circuit procedures in an orderly system as follows:

- Connect the transistor as you would out of circuit.
- If the transistor tests OK, move on.
- If the transistor tests NG, unsolder the base or gate and repeat the test.
- If the transistor tests OK now, move on. If not, unsolder the collector or drain, and make one final test. This one is conclusive.
- If you are testing an FET, use the soldering/desoldering technique described at the start of this article.

Construction

All wiring is point-to-point. Figure 1 is drawn to be a mechanical as well as an electrical diagram. Note that the (OFF) post on S3 is a tie point for Q1's base and R9. Q1 is an emitter-follower current amplifier which drives the meter directly. R9 attenuates the drive to Q1 so that a short between RED (+) and (BG) makes the meter read full scale.

I made the round panel markers from a self-stick file folder label. You can also use ordinary typing paper with a speck of glue. Mark them with a typewriter or fine-tip pen. Use a 1/4-inch punch to extract the markers from the label. (Rub-on lettering is another possibility. Ed.)

R8 is used to load the supply to get 2 volts between (+) and (-). R4 sets the meter to read full scale. There is some interaction between them. Figure 1 and Detail A show switches S1-3 going counter-clockwise from (OFF), as seen from the rear of the panel while you're doing the wiring. From the front of the panel, the rotation is clockwise. Photos A and B show an inside view and the completed tester. 

THE MULTIPLE RECEIVER SOLUTION

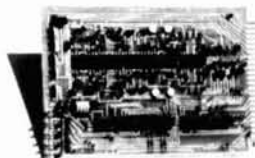

4 Channel Signal-to-Noise Voter

- Expandable to 32 Channel by Just Adding Cards
- Continuous Voting
- LED Indicators of COR and Voted Signals
- Built-in Calibrator
- Remote Voted Indicators Pinned Out
- 4 1/2 x 6 Double Sided Gold Plated 44 Pin Card
- Remote Disable Inputs
- MORE

Built, tested and calibrated with manual

\$350.00

Telephone interface now available
For more information call or write

DOUG HALL ELECTRONICS
Voter Department
815 E. Hudson Street
Columbus, Ohio 43211
(614) 261-8871

✓ 127

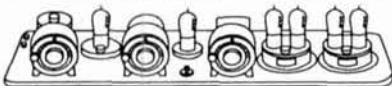

**IF YOU BUY, SELL OR COLLECT
OLD RADIOS, YOU NEED...**

ANTIQUE RADIO CLASSIFIED

*Antique Radio's
Largest-Circulation
Monthly Magazine*



FREE SAMPLE COPY!

Classifieds - Ads for Parts & Services
Articles - Auction Prices-Flea Market Info.
Also: Early TV, Ham Equip., Books, Telegraph,
Art Deco, 40's & 50's Radios & more...

Free 20-word ad each month. Don't miss out!

6-Month Trial - \$11.

1-Year: \$19 (\$28 by 1st Class)

Foreign by air - Canada: \$30; Mexico: \$28; Other: \$55.

A.R.C., P.O. Box 2-A4, Carlisle, MA 01741

✓ 126





Sparky J Antennas

Balanced J-pole antennas that roll up small enough for your pocket or briefcase, yet have the punch of a full size half-wave radiator. A great answer for apartment dwellers or as a super emergency antenna. Don't leave home without one, because nobody beats these J's—nobody!

Ant here is a Sparky J

20 M	-\$49.95
15 M	-\$43.95
10 M	-\$39.95
5 M	-\$32.95
2 M	-\$29.95
7 M	-\$24.95
Add \$5 S & H	

Sparrow Hawk Communications
450-H Westfield Rd Alpine, UT 84004
Order direct from the factory (801) 756-7842

✓ 124



PORTA-BEAM

At last! A completely portable 2 meter three element Delta loop beam. Easy to set up with no small parts to lose. Low VSWR over entire 2 meter band. Gain equivalent to a 4-element Yagi. All elements and feed line with BNC connector store inside a 3 ft boom. An ideal emergency antenna, backpackable (18 oz.), general field use with accessory mast. Money back if not fully satisfied.

Model DL-146

\$84.95
(Free shipping US/CAN)

SUMMITTEK
P.O. Box 520011-H
Salt Lake City, UT 84152 AM (801) 277-4205



✓ 125

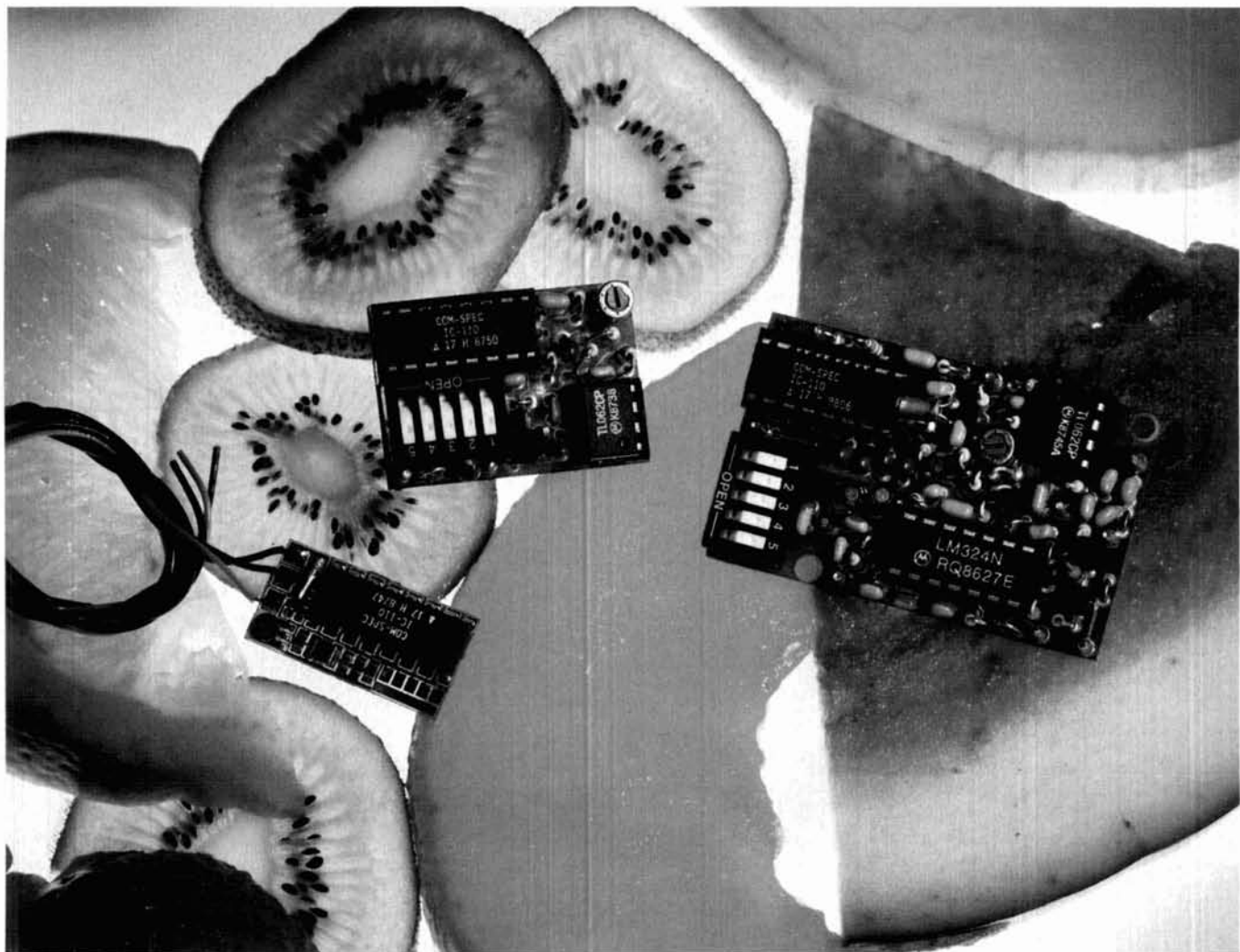

Choice Selection.

Now you can have it all! Take all the qualities you've come to depend on in our programmable CTCSS tone equipment: Astonishing Accuracy, Instant Programming, Unequaled Reliability; and add full spectrum tone versatility, multi-tone capability without diodes, a reprogrammable memory...It's our new harvest of CTCSS tone equipment.

The choice is yours! If standard CTCSS EIA tones do not suit your taste, select any 32 tones of your liking from 15.0Hz to 255.0Hz. And if you change your mind, no problem; the memory can be changed in your shop with our HHP-1 programmer, or at our factory for free. Your working tone is accessed by a simple DIP switch, so there's no fussing with counters or other test equipment.

Call today toll-free and find out more about this fresh new flexibility in tone signalling, and don't forget to ask about multi-tone switching without cumbersome diode networks or binary switches.

It's all brought to market by the people who introduce the freshest ideas in tone signalling, and of course our customary same day shipping and one year warranty apply.

TS-32P CTCSS ENCODER-DECODER Based on the time proven TS-32, the industry standard for over a decade. The TS-32P gives you the added versatility of a custom, changeable memory base. A low price of \$57.95 makes it an even sweeter deal.

SS-32P ENCODER Based on the equally popular SS-32 encoder. Available for CTCSS, or audible burst tones up to 6550.0Hz. Price is \$28.95.

SS-32SMP SUB-MINIATURE ENCODER Our smallest encoder for handheld applications. Now you can satisfy that customer that needs to access multiple repeater sites with a radio that has precious little space inside. At \$27.95, the price is small too.

HHP-1 HANDHELD PROGRAMMER For programming the 32 memory locations in any of our new programmable products, including our SD-1000 Two-Tone Sequential decoder. The HHP-1 is battery operated for field use, and will program ANY 32 tones from 15.0 to 6550.0Hz in .1Hz. increments. Price is \$199.95.



COMMUNICATIONS SPECIALISTS, INC.
426 West Taft Avenue • Orange, CA 92665-4296
Local (714) 998-3021 • FAX (714) 974-3420 • Entire U.S.A. 1-800-854-0547

For A HRO 72 Page
Communication Equipment Catalog
Send \$1.00 to any HRO Store

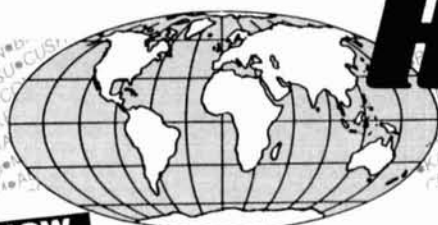

HAM RADIO OUTLET

LARGEST HAM OUTLET IN THE WORLD

NOW

9 STORE BUYING POWER



GEOCHRON
GLOBAL
TIME
INDICATOR

SALE

- Detailed illuminated map shows time, time zone, sun position and day of the week at a glance for any place in the world.
- Continuously moving - areas of day and night change as you watch.
- Mounts easily on a wall. Size: 34 1/2" x 22 1/2".

~~\$1295~~ **\$1159.95 DELIVERED IN U.S.**



A3 DX THAT STANDS OUT FROM THE CROWD

10, 15, 20 Meters

cushcraft

Whether busting pileups, rag chewing or hunting rare DX, the A3 stands out from the crowd with the perfect combination of easy assembly, the right size, rugged durability and great performance.

Mast not included

REG. 399.00

SALE 269.95

Plus Shipping

SALE

- Boom Length 14 ft., Weight 27 lbs.
- Wind Surface Area 4.36 ft.

concept



VHF/UHF SOLIDSTATE AMPLIFIERS

Contemporary design, quality and a 5 year warranty on parts and labor. 6 months on the RF Final transistors. All amplifiers have GaAsFET receive pre-amps and high SWR shutdown protection.

US TOWER CORPORATION

MA-40
40' TUBULAR TOWER

~~\$809~~ **SALE! \$629**

MA-550
55' TUBULAR TOWER

~~\$1369~~ **SALE! \$999**

- Handles 10 sq. ft. at 50 mph
- Pleases neighbors with tubular streamlined look

TX-455
55' FREESTANDING CRANK-UP

- Handles 18 sq. ft. at 50 mph
- No guying required
- Extra-strength Construction
- Can add raising and motor drive accessories

Shown with optional MARB rotor base

TOWERS RATED TO EIA SPECIFICATIONS
OTHER MODELS AT GREAT PRICES
IN STOCK FOR QUICK DELIVERY

TEN-TEC

MADE IN U.S.A.



PARAGON 585

- Ten-Tec QSK cw, real FSK and sideband audio
- Select any filter in any mode
- TX 160 through 10 meters • All mode superiority
- RX 100 kHz to 30MHz • A premier HF rig



TITAN 425

- Pair 3CX800A7 • External Power Supply
- Performance at legal limit
- 3 MS QSK, 1.6 to 22 MHz • Assures "Loaf Along"
- With authorized modification through 29.999 MHz

IN STOCK NOW! FREE SHIPMENT!

AEA

Advanced Electronic Applications

PK-232 Multi-mode Data Controller

SALE CALL



- NEW IBM Fax Screen Display Program Available
- Transmit/Receive on Six Modes
- CW/RTTY/ASCII/AMTOR/Packet/FAX
- IBM and Commodore terminal programs available
- Radio Ports for HF and VHF

In Stock for Quick Delivery
Free Shipment

Kantronics/KAM



True dual port - simultaneous HF/VHF packet operation

- Personal Bulletin Board
- RTTY/ASCII/AMTOR/CW/Weather Fax
- Programmable MARK and SPACE tones
- Terminal programs for PC compatibles and Commodore
- WEFAX programs for PC, Commodore, and Macintosh

One-year Warranty

CALL FOR LOW, LOW PRICE

FREE SHIPMENT
Most items over \$100 UPS surface

All Major Brands in Stock Now!

Call any of our 800 numbers coast to coast from most parts of the country.

CALL TOLL FREE
IN CALIFORNIA CALL STORE NEAREST YOU

MID-WEST/WEST
ANAHEIM, 9 to 5:30 PST

SOUTHEAST
ATLANTA, 9 to 5:30 EST

MID-ATLANTIC
WOODBRIIDGE, 9 to 5:30 EST

NEW ENGLAND
SALEM, 9 to 5:30 EST

1-800-854-6046

1-800-444-7927

1-800-444-4799

1-800-444-0047



Toll free including Hawaii. Phone Hrs: 7:00 am to 5:30 p.m. Pacific Time. California, Arizona and Georgia customers call or visit nearest store. California, Arizona, Georgia and Virginia residents please add sales tax. Prices, specifications, descriptions subject to change without notice.

For A HRO 72 Page
Communication Equipment Catalog
Send \$1.00 to any HRO Store

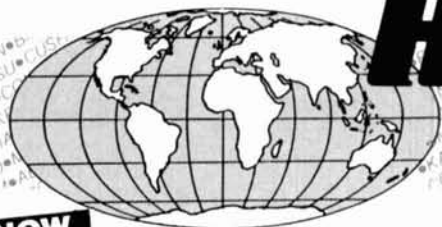

HAM RADIO OUTLET

LARGEST HAM OUTLET IN THE WORLD

NOW

9 STORE BUYING POWER

ICOM IC-765



100W, 100kHz to 30MHz
HF ALL BAND TRANSCEIVER
Dual VFO system

SALE! CALL FOR PRICE

ICOM IC-781



THE ULTIMATE
150 W, ALL BAND
HF TRANSCEIVER

GREAT PRICE!

ICOM IC-900 MULTI-BAND MOBILE



YOU CAN OPERATE SIX BANDS
WITH ONE CONTROLLER!
2 MTR 25/45W, 440 MHz 10 MTR, 6 MTR,
220 MHz & 1.2 GHz 10 MEMORIES
**ARE YOU READY FOR
1.2 GHz OPERATION?**

ICOM A Models 25W, H Models 100 W

IC-275/A275H, 138-174 MHz
IC-375A, 220 MHz
IC-475A/475H, 430-450 MHz



LOW PRICE!

ICOM IC-735



100 W, 100 KHz-30 MHz
Dual VFO Receiver

CALL FOR LOW, LOW PRICE

BULLETIN

ege has
joined the
**HAM RADIO OUTLET
NATIONWIDE TEAM**



NOW LOCATED IN
**SALEM, NH
WOODBRIDGE, VA**

**THIS GIVES YOU EVEN
BETTER RESPONSE WITH
LOW-LOW OUTLET PRICES
& RAPID DELIVERIES
COAST TO COAST.**

ICOM HAND-HELD VHF/UHF



IC-02AT IC-2AT 2MTR
IC-3AT 220 MHz
IC-04AT IC-4AT 440 MHz

ICOM IC-725



100W, 30kHz to 33MHz
HF ALL BAND TRANSCEIVER
GREAT PRICE



Bob Ferrero W6RJ
President/Owner
Jim Rafferty N6RJ
VP-National
Sales Manager

ANAHEIM, CA 92801
2620 W. La Palma
(714) 761-3033, (213) 860-2040
Between Disneyland &
Knotts Berry Farm

ATLANTA, GA 30340
6071 Buford Hwy.
(404) 263-0700
Larry, Mgr. WD4AGW
Doraville, 1 mi. north of I-285

BURLINGAME, CA 94010
999 Howard Ave.
(415) 342-5757
George, Mgr. WB6DSV
5 miles south on 101 from SFO

OAKLAND, CA 94606
2210 Livingston St.
(415) 534-5757
Rich, Mgr. WA9WYB
IS-880 at 23rd Ave. Ramp

PHOENIX, AZ 85015
1702 W. Camelback Rd.
(602) 242-3515
Bob K7RDH, Gary WB7SLY, Mgr.
East of Hwy. 17

SALEM, NH 03079
224 N. Broadway
(603) 898-3750 1-800-444-0047
Curtis, Mgr. WB4KZL
28 miles north of Boston exit 1 I-93

SAN DIEGO, CA 92123
5375 Kearny Villa Rd.
(619) 560-4900
Tom, Mgr. KM6K
Hwy. 163 & Claremont Mesa Blvd

WOODBRIDGE, VA 22191
14803 Build America Drive
(703) 643-1063 1-800-444-4799
John, Mgr. WB4GJZ
Exit 54, I-95 South to US RT 1

STORE HOURS 10 AM-5:30 PM
CLOSED SUNDAYS

VAN NUYS, CA 91411
6265 Sepulveda Blvd.
(818) 988-2212
Al, Mgr. K6YRA
San Diego Fwy. at Victory Blvd

FREE SHIPMENT
Most items over \$100
UPS surface

All Major Brands in Stock Now!

Call any of our 800 numbers coast to coast from most parts of the country.

CALL TOLL FREE
IN CALIFORNIA CALL STORE NEAREST YOU

MID-WEST/WEST

ANAHEIM, 9 to 5:30 PST
1-800-854-6046

SOUTHEAST

ATLANTA, 9 to 5:30 EST
1-800-444-7927

MID-ATLANTIC

WOODBRIDGE, 9 to 5:30 EST
1-800-444-4799

NEW ENGLAND

SALEM, 9 to 5:30 EST
1-800-444-0047



Toll free including Hawaii. Phone Hrs: 7:00 am to 5:30 p.m. Pacific Time. California, Arizona and Georgia customers call or visit nearest store. California, Arizona, Georgia and Virginia residents please add sales tax. Prices, specifications, descriptions subject to change without notice.

Imagine your own
HAM TOWER
 with its majestic
 curves, handling the
 most extreme loading
 conditions, sweeping
 into the heavens.

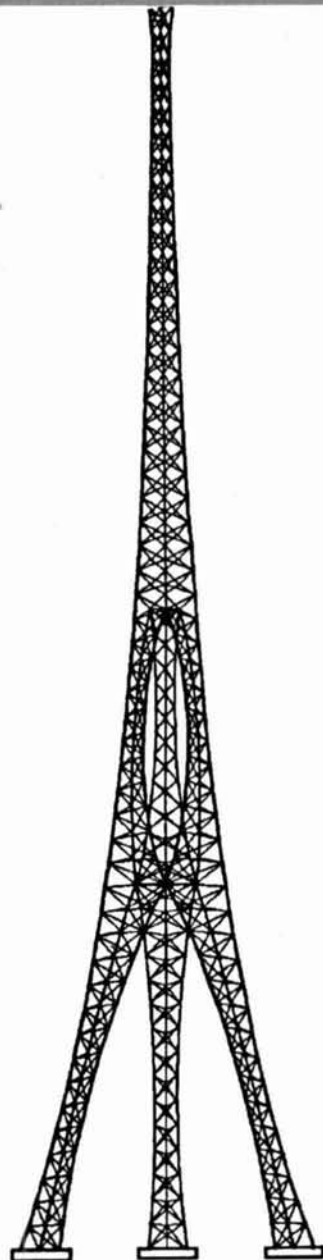

This is an actual scaled down version of the 761' LANDMARK™ TOWER constructed in Washington, D.C.

Now imagine the easy to follow instructions and kit.

For information contact:

ADELPHON, INC.
 P.O. Box 7256
 Fort Worth, Texas 76111
 (817) 335-8666



PacComm

- Advanced Technology
- Enduring Value

New! **PC-320 / TNC-320** PACKET CONTROLLERS

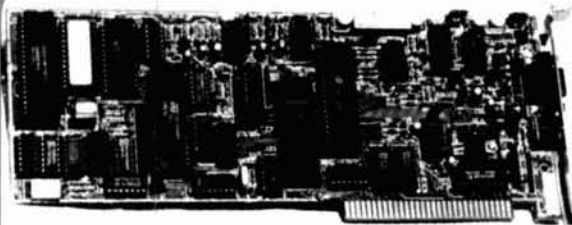

Announcing the next generation of packet controllers for the serious operator! The new inboard PC-320 (shown), is designed to work with all PC/XT, PC/AT, and Tandy 1000 series computers. The TNC-320 outboard controller offers many of the same high quality features!

PC-320 features . . .

- Dual modems for optimal VHF and HF operation.
- Appears as regular PC serial port (COM 1-4) - operates with any terminal program just like an external TNC.
- Dual Powered - operates from PC or external power. Continues complete operation even when the PC is turned off!
- Personal Message System - the most advanced personal mailbox available... included at no extra charge.
- Displays on-screen HF tuning indicator and simulated 'LEDs'.

PC-320

\$209⁹⁵

TNC-320... **\$194.95**

(Wired & Tested / 1 Year Warranty)

For complete info & specifications Call (813) 874-2980 / To Order, Call

Toll Free: 1-800-223-3511

Major Credit Cards Accepted!

PacComm • 3652 West Cypress Street • Tampa, Florida 33607

Please send PC-320 TNC-320 More Information FREE Catalog

Name _____ Call _____

Address _____

State _____ Zip _____ Card# _____ Exp. Date _____

MONEY BACK GUARANTEE! Add \$4.00 shipping/handling per order. FL residents add 6% sales tax. Major Credit Card give number, expiration and signature. FAX: 813-872-8696

**New from
 AOR**

**2000 Channels
 5MHz to 2000MHz**



AR2515

- Covers 5MHz to 2000MHz in AM/FM/Wide FM modes. Continuous coverage
- 2000 Channel Memory
- 1984 Scan Frequencies & 16 Search Groups
- Scan/Search speeds up to 36 channels or increments per second.
- Built in RS 232 computer interface
- 25 Day Satisfaction Guarantee. Full Refund if not Satisfied.
- Size: 3 1/2" H x 5 1/4" W x 7 1/4" D Wt: 2 lb 10 oz.
- Supplied with AC & DC power cords. Telescopic antenna

Total Price, Freight Prepaid (Express Shipping Optional)
 *Upgrades of AR2002's to AR2515 specs Available

\$695.00



COMMUNICATIONS
 10707 E. 106th St. Indpls., IN 46256

Toll Free 800-445-7717

Visa and MasterCard (COD slightly higher)



In Indiana 317-849-2570 Collect FAX (317) 849-8794



EVERY ISSUE of

HAM RADIO

now available on microfiche!

The entire run of *Ham Radio Magazine* (March, 1968 thru last year) is ready to ship to you in one, easy to use format.

Our 24x microfiche is easy to read and very compact. We offer a hand held reader for \$75, and a desk model for \$200. Libraries have these readers.

As a bonus, you will receive *Ham Radio Horizons* (3/77 thru 12/80) free.

Everything is included, front cover to back - ads too!

Annual updates will be offered for \$10.

Send \$185 payment (visa/mc accepted) to:

BUCKMASTER

BUCKMASTER PUBLISHING

Route 3, Box 56

Mineral, Virginia 23117

703/894-5777 visa/mc 800/282-5628

A HIGH PERFORMANCE DUOBAND YAGI FOR 15 AND 20 METERS

Two PV4s on a single boom

By David J. Rodman, M.D., KN2M, 368 Hedstrom Drive, Buffalo, New York 14226

Multiband antenna systems with traps, loading coils, or similar devices are common in Amateur Radio. These antennas have many distinct advantages — they can be purchased easily, are constructed simply with manufacturers' kits, are generally fed directly with a single coax line, and give modest performance. Monoband antennas aren't as popular — except within the realm of antenna aficionados, like contest enthusiasts. The superior gain and efficiency advantages of monoband antennas are often outweighed by the antennas' large size, cost, and complexity on a single tower.

I came up with this antenna project when the bands were in the doldrums of the sunspot cycle; that's why it doesn't address a triband system that would normally include the 10-meter band. I made an attempt at a compromise based on the needs of Amateurs who require multiband systems for the most popular HF bands, with the efficiency that approaches separate monoband antennas.

Theory

Wilson Electronics Corporation was the most recent manufacturer to address the idea of a duoband antenna system. Such antennas were adequate performers on the lower frequency; however, when used with the higher frequency, operators found not only that the gain was less than advertised, but the front-to-back ratio was dismal. While the use of two harmonically related or unrelated frequencies on the same boom has been addressed, don't assume that harmonically unrelated antennas in this configuration are devoid of element interaction.¹ In fact, just the opposite is true. Positioning harmonically related or unrelated elements in close proximity to any antenna tends to invite electrostatic shielding in some configurations. This shielding affects the higher frequency antenna more than its lower frequency counterpart

because of the size of the elements. The effects of this interaction are most pronounced when antennas share the same boom. Electrostatic shielding also alters antenna performance when separate antennas are spaced inadequately.

Duoband antennas show degradation of front-to-back ratios on all frequencies, and forward gain reduction on the higher frequency antenna, as a result of electrostatic shielding. You'll need to anticipate this problem before you start to build if you want to improve your antenna's performance. Empirical estimations of element placement appear to be no better than chance in designing such antennas, and yield equally poor performance. To ease this burden for Yagi design, use computer modeling programs to simulate antenna performance before actual construction. These programs let you make accurate and precise iterations of design parameters in minutes.

Design approach

I used MININEC to develop my antenna. MININEC lets you alter element size and spacing until both forward gain and front-to-back ratios are maximized at the desired operating frequency and height above ground. Actual antenna testing with distant observers showed that measured performance can even surpass computer predictions.

Before I discuss the optimization technique, I'd like to make several points concerning computer modeling. First, actual MININEC calculations are dependent upon the CPU type, clock speed, and the presence of a mathematical co-processor. Use the fastest system available to speed your calculations. Second, it's extremely difficult to model commercial multiband trap Yagi antenna designs. You need to specify all complex reactance values along with their locations in three-dimensional space precisely, before even attempting this. Don't expect to redesign trap antennas easily with such software. Finally, the calculations performed for my antenna required exhaustive changes in element position and length before I made my final design selection. Conceptually, it's similar to tuning a circuit with eight unknowns. The system performs as described for the dimensions and element taper specified. Small deviations from these specifications won't necessarily produce the same results. If you want to alter these values, I suggest you use computer modeling to make your changes.

The method required to maximize the performance of this

\$15.00

ANTENNA IMPEDANCE MATCHING

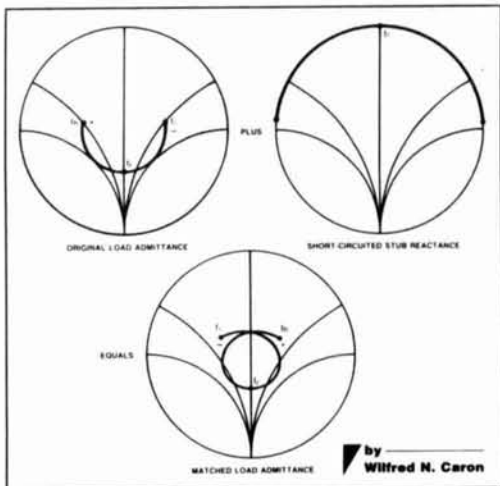

New from ARRL

Following the hard-cover style of *Transmission Line Transformers*, and *Yagi Antenna Design*, **Antenna Impedance Matching** is written with the advanced amateur, antenna design engineer and technician in mind, but even if you don't have any special expertise you'll be able to develop very sophisticated systems. This is probably the most comprehensive book ever written on the use of Smith Charts™ in solving impedance matching problems. This 224-page book is of importance to those who want to maximize antenna effectiveness. A properly matched antenna as the termination for a line minimizes feedline losses, and power can be fed to such a line without the need for a matching network at the line input. **Antenna Impedance Matching** is a "must" for the antenna designer and serious amateur. The price is \$15, please add \$3.50 for shipping and handling.



THE AMERICAN RADIO RELAY LEAGUE, INC.
225 MAIN STREET
NEWINGTON, CT 06111

✓ 133

CUSTOM CRYSTALS

Crystals for many applications

For over 37 years, ICM has manufactured the finest in quartz crystals for every conceivable purpose.

A wide selection of holders are available to fit most any requirement. Our computer database contains crystal parameters for thousands of equipment types.

Need crystals for communications, telemetry, industrial, or scientific applications? Let ICM's sales department assist you to determine which type of crystal is best for you.

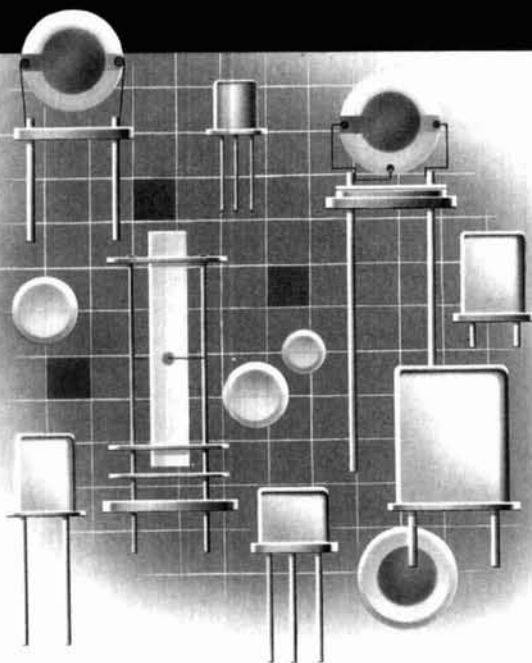

Can we solve your crystal problem?

For special purpose crystals, special holders, special sizes, call our crystal sales department. We will be pleased to provide recommended data.



International Crystal Manufacturing Co., Inc.

PO Box 26330, 701 W. Sheridan,
Oklahoma City, OK 73126-0330
Phone (405) 236-3741
Telex 747-147
Facsimile (405) 235-1904

FIGURE 1

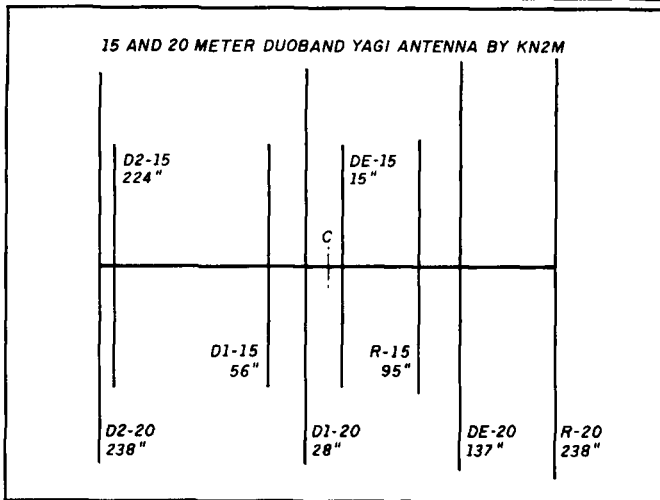

Element name code and distance from boom center.

or any similar project is as follows. First, start with a design showing element size, location, and diameter. Translate this data into a simple mock-up of the antenna (ignoring element taper) modeled in free space. With MININEC, calculations in free space are much faster than those performed over real ground. When you've produced a suitable design, model the antenna over real ground at the desired height. Once your design proves satisfactory, make a real model of the antenna with the actual taper schedule in free space. I used a BASIC program written by Bill Myers, K1GQ, called TAPER.² Finally, model the actual antenna over real ground. At any point in the analysis, you can vary element location to maximize the front-to-back ratio and minimize loss in forward gain. These values are generally inversely related, and give many opportunities for producing either a suitable design or one that becomes increasingly undesirable. Throughout your calculations, remember to accommodate maximum gain and front-to-back ratios at the design frequency.

Results

The antenna design is shown in **Figure 1**. This antenna system is based on the PV4 antenna designed originally by the late Jim Lawson, W2PV. The antenna was only recently introduced to the general Amateur population.² I read several sources before building the antenna that provided excellent background on construction.¹ The characteristics of this array are similar to previous descriptions in that gain is fairly constant over each band, but the front-to-back ratio peaks in a narrower frequency range.

Essentially, I've mounted two of these antennas on the same boom and redesigned them carefully to maximize antenna performance. Lawson was the first to note that gain is dependent on boom length. He also observed that front-to-back ratios are maximum at odd multiples of quarter-wave boom lengths.³ Here, in contrast to those findings, gain and especially the front-to-back ratio of the higher frequency antenna are inevitably decreased by the electrostatic shielding of two antennas on the same long boom. The only way to maximize the front-to-back ratios of the two antennas is to perform repeated calculations with MININEC. Despite this technique, the gain on 15 meters is less than on 20 meters for the same electrical boom length. A rule of thumb when designing mul-

ti-band antennas like the one described here is that the gain of the higher frequency antenna will approximate a three-element array of lesser boom length. A comparison of this data is shown in **Table 1**. If you can accept the fact that the 15-meter portion behaves more like a three-element antenna on a 0.3-wavelength boom, then this is by all accounts an excellent system. You now have a multiband Yagi without traps, but with maximum gain and front-to-back ratio at the design frequency. The system does require separate feedlines and matching devices for each band.

As you'll note in **Table 2**, the design uses relatively large element diameters. I selected aluminum sizes in an attempt to keep construction as rugged as possible. Moreover, with a large element diameter, the SWR bandwidth is increased by maintaining relatively low element Q. You can match your antenna with a gamma match or a beta device, whichever you like better. Note that the driven element length here has been shortened somewhat to produce the capacitive reactance necessary for the gamma match actually used in construction.

TABLE 1

Duoband antenna electrical characteristics for 14.175 and 21.2 MHz.				
	Forward gain	Calculated F/B	Measured F/B	Input Z
20 meters	10.0 dB	25.4 dB	40 dB	19.4-j22.8
15 meters	7.9 dB	25.1 dB	35 dB	14.9-j20.1

TABLE 2

Duoband antenna element half-length data for 14.175 and 21.2 MHz.					
Location	Length 15 inches	OD 15 inches	Length 20 inches	OD 20 inches	Material
Segment 1	72	1.125	72	1.125	6063-T6 0.049 wall
Segment 2	End piece varies	1.0	68	1.0	6063-T6 0.049 wall
Segment 3	none	none	End piece varies	0.875	6063-T6 0.049 wall

TABLE 3

Duoband antenna element end piece length data for 14.175 and 21.2 MHz.				
Element	Length 15 inches	Length 20 inches	Distance to boom center inches	
Reflector	67.0	74.4	15-95	20-238
Driven element	59.0	58.2	15-15	20-137
Director no. 1	57.6	55.9	15-56	20-28
Director no. 2	55.0	49.9	15-224	20-238

AMATEUR TELEVISION

SMILE! YOU'RE ON TV



Only
\$329

Designed and
built in the USA
Value + Quality
from over 25 years
in ATV...W6ORG

With our all in one box TC70-1, 70cm ATV Transceiver, you can easily transmit and receive live action color and sound video just like broadcast TV. Use any home TV camera or VCR by plugging the composite video and audio into the front VHS 10 pin or rear phono jacks. Add 70cm antenna, coax, 13.8 Vdc and TV set and you are on the air...it's that easy! TC70-1 has >1 watt p.e.p. with one xtal on 439.25, 434.0 or 426.25 MHz & properly matches Mirage D15, D24, D100 amps for 15, 50, or 70 watts. Hot GaAsfet downconverter varicap tunes whole 420-450 MHz band to your TV ch3. Shielded cabinet 7x7x2.5". Req. 13.8 VDC @ .5A Transmitters sold only to licensed amateurs, for legal purposes, verified in the latest Callbook or send copy of new license. Call or write now for our complete ATV catalog including downconverters, transmitters, linear amps, and antennas for the 70, 33, & 23cm bands.

(818) 447-4565 m-f 8am-5:30pm pst.

Visa, MC, COD

P.C. ELECTRONICS

Tom (W6ORG)

2522 Paxson Ln Arcadia CA 91006

Maryann (WB6YSS)

134

Employment opportunities at Cushcraft Corporation

Antenna Design Engineers

3 to 1000 MHz Range

Enthusiastic experienced Yagi, Omni, and mobile antenna design engineer wanted to lead our design team.

We are also seeking entry level BSEE to join the team.

This is your opportunity to make a difference.

Landmobile Antenna Salesperson

Excellent opportunity for experienced salesperson with two-way radio familiarity. Market our state-of-the-art Voice and Data Transmission Antennas to the growing Landmobile industry. Business-to-Business sales. Established territory. Commission.

Excellent benefits.

Call Now —

Cushcraft/Signals
48 Perimeter Road
Manchester, NH 03103
603-627-7877

Construction

Before assembling this antenna, remember to follow and reproduce exactly the dimensions specified by computer modeling (Table 3). If you don't you will get a less than optimal result, first noted in decreased front-to-back ratios.

There are advantages to using this particular configuration with a 40-foot boom. First, this is an excellent length for the 20-meter band, giving 10-dBi forward gain. Shortening the boom sacrifices gain on the most popular HF band. Second, the boom material (3-inch OD 0.065-inch wall aluminum tubing) is available in 20-foot lengths. The boom halves can be joined with a 3-foot piece of larger wall 2.875-inch OD tubing.

Be sure to place furniture foot caps on the ends of all elements during construction. This eliminates the risk of damage during ice storms. I also suggest using conductive grease at all element telescoping positions. Use simple hose clamps to secure each telescoping joint. To help retard weather corrosion, coat all hardware surfaces during construction with a clear aerosol varnish designed for outside use.

As I mentioned before, there are mechanical disadvantages when using the PV4 antenna. Because you use odd element spacing, the driven element location and matching device are at some distance from the mast. This antenna also needs a substantial boom brace because of the number and spacing of elements, and the fact that PV4 antennas tend to have a center of gravity away from the boom center. You'll note that the 15-meter portion of this antenna has been moved towards the director end of the boom. This makes it possible to adjust the matching device for that band while the antenna is on the tower. The array also has less tendency to be reflector heavy.

Many of you may shy away from any antenna project that requires construction and adjustment of a matching device. Because this antenna requires some reorientation during adjustment of the match for 20 meters, I'd like to make some points that should simplify these tasks. First, a calibrated noise bridge is invaluable for determining feedpoint resistance and reactance values. Second, if you use an odd multiple half-wavelength line for these measurements, you can even make them in the shack. Third, the actual feedpoint impedance may be measured more conveniently and with greater safety at a height lower on the tower, as it may be necessary to tilt the array upwards to reach and adjust the match.

Conclusion

The antenna design I've presented shows how current technology allows optimization of Yagi performance beyond previous methods. Computer analysis now replaces most antenna range testing. I've used my antenna at heights of up to 1.4 to 2 wavelengths above the ground. It performed well when contacting DX stations. The front-to-back ratios, both predicted and measured, are extremely favorable when compared with commercial antennas.

This antenna, like any multiband, has limitations. However, should you build one of these, you should notice definite improvements in band-centered gain and front-to-back ratios over multiband commercial antennas. Using a duoband antenna like this for the new 17 and 12-meter bands should give satisfying results with a single array. 

REFERENCES

1. G.L. Hall, Ed., *The ARRL Antenna Handbook*, 15th Edition, American Radio Relay League, 1988
2. W. Myers, "The W2PV Four Element Yagi," *QST*, October 1986, pages 15-19
3. J.L. Lawson, *W2PV, Yagi Antenna Design*, American Radio Relay League, 1986

Tuned To The New World Of Amateur Radio

**From Novice to Extra Class
Cushcraft has the antenna
you need.**

Cushcraft offers high performance antennas to make every phase of your ham radio activity more satisfying. We have been creating innovative and exciting new products for more than 35 years. Call or write for a free copy of our full line antenna and accessory catalog or see your local dealer.

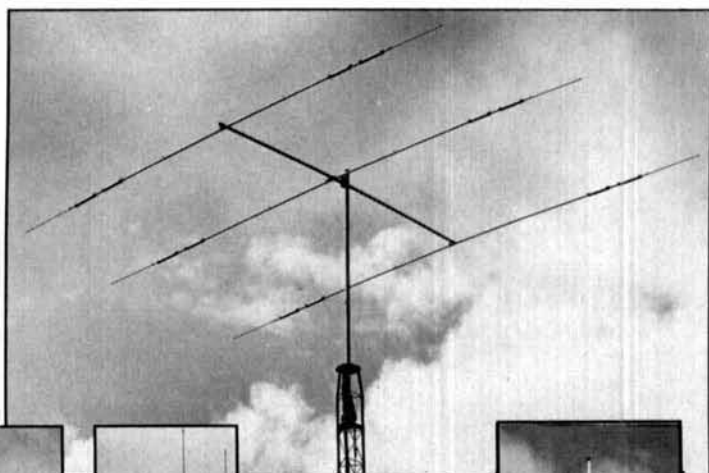

HF TRIBAND BEAM A3. The most popular compact 10, 15, 20 meter beam. **A4S.** A high performance 18' long wide-band beam with all stainless steel hardware. 40 meter add on kits for each

NEW
CUSHCRAFT/SIGNALS magnetic mount mobile for 10 meters. An ideal companion to the new 10 meter multi mode rigs. Model CS28M.

AP8 VERTICAL. Covering 10, 12, 15, 17, 20, 30, 40, 80 Meters. Great choice for Novice to Extra class.

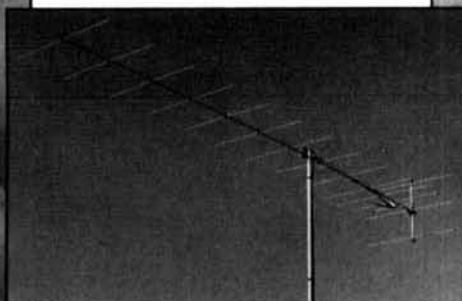
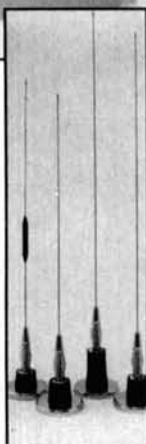

BOOMERS. The contest winners and distance record holders. Computer enhanced design for better gain, pattern and strength. VHF and UHF models for SSB, FM and other activities.

RINGO RANGER II. Still the world's favorite 2 meter, 70 cm or 220 MHz omni antenna, with more gain. A must for your FM or packet station.

FAST ACTION GAS TUBE LIGHTNING ARRESTERS. Protect your valuable radio equipment. High and low power models with SO-239 or N connectors.

NEW 10, 18, 24 MHz **ROTATABLE DIPOLE.** Mounts easily on the same mast as your tribander or other antennas. Bi-directional pattern gives excellent performance. Model D3W.

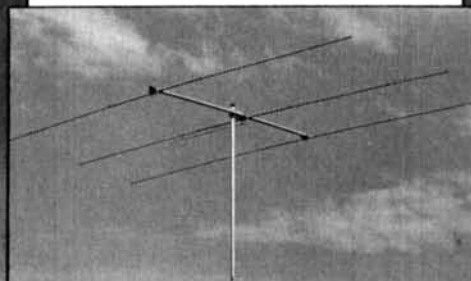

NEW **NEW 10 METER 3 ELEMENT** for the novice, technician or any ham who wants more gain with a good front to back ratio. Model TEN-3

NEW **R5 HALF WAVE 10, 12, 15, 17, 20 METER VERTICAL.** Amazing DX performance in a small space without ground radials. Includes a solid state broadband impedance matching network. Model R5.

SKYWALKER MONOBAND. 10, 12, 15 and 20 meter Yagis for more contacts, less waiting and a better signal. Preferred by contesters and DX-Peditions.

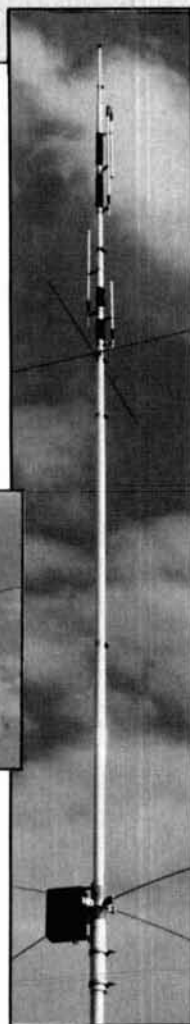

 **cushcraft**
CORPORATION
THE ANTENNA COMPANY

P.O. Box 4680, 48 Perimeter Road, Manchester, NH 03108 USA
Telephone: 603-627-7877 / Telex: 4949472 / FAX 603-627-1764

AVAILABLE THROUGH DEALERS WORLDWIDE

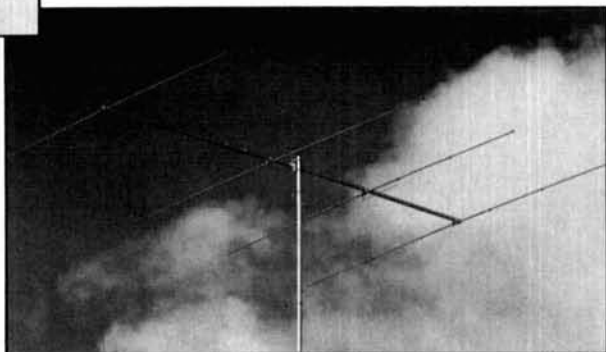

here is the next generation Repeater
2 meters - 220 - 440

MARK 4CR

The **only** repeaters and controllers
with REAL SPEECH!

No other repeaters or controllers match Mark 4 in capability and features. That's why Mark 4 is the performance leader at amateur and commercial repeater sites around the world. Only Mark 4 gives you Message Master™ real speech • voice readout of received signal strength, deviation, and frequency error • 4-channel receiver voting • clock time announcements and function control • 7-helical filter receiver • extensive phone patch functions. Unlike others, Mark 4 even includes power supply and a handsome cabinet.

Call or write for specifications on the repeater, controller, and receiver winners.

Create messages just by talking. Speak any phrases or words in any languages or dialect and *your own voice* is stored instantly in solid-state memory. Perfect for emergency warnings, club news bulletins, and DX alerts. Create unique ID and tail messages, and the ultimate in a real speech user mailbox — only with a Mark 4.



MICRO CONTROL SPECIALTIES

Division of Kendecom Inc.
23 Elm Park, Groveland, MA 01834 (508) 372-3442

TELEX 4932256 Kendecom

FAX 508-373-7304

135

"NEW" DUAL & TRI BAND SUPER "LINEAR" ANTENNAS

MODEL	FREQUENCY	GAIN	POWER	LENGTH	USE
CA-2X4Z	146 MHz 446 MHz	8.2dB 11.5dB	200W	15' 4"	BASE/REPEATER
CA-2X4FX	146 MHz 446 MHz	4.5dB 7.2dB	200W	5' 11"	BASE/REPEATER
CA-2X4M	140-155 MHz 440-460 MHz	4.5dB 7.0dB	150W	5'	MOBILE
CA-2X4SR	146 MHz 446 MHz	3.8dB 6.2dB	150W	3' 4"	MOBILE
CX-901	146 MHz 446 MHz 1.2 GHz	3.0dB 6.0dB 8.4dB	150W	3' 6"	BASE/REPEATER
CX-801	146 MHz 446 MHz 1.2 GHz	3.0dB 6.8dB 9.6dB	100W	3' 3"	MOBILE
CA-630TN	146 MHz 446 MHz 1.2 GHz	2.15dB 2.15dB 5.5dB	150W 50W	1' 5"	MOBILE

NEW! ULTRA COMPACT SWR/POWER METERS



CM-200 144-150 MHz
CM-300 200-250 MHz
CM-400 420-460 MHz
CM-420 140-460 MHz
CM-900 850-950 MHz
CM-1200 1250-1350 MHz

DEALERS INQUIRIES WELCOME

CALL YOUR DEALER



1275 N. Grove St.
Anaheim, CA 92806
(714) 630-4541
FAX (714) 630-7024

Electronic Repair Center Servicing

Amateur Commercial Radio

The most complete repair facility on the East Coast.

Large parts inventory and factory authorized warranty service for Kenwood, Icom and Yaesu.

SEND US YOUR PROBLEMS

Servicing "Hams" for 30 years, no rig too old or new for us.

HAMTRONICS, INC.

4033 Brownsville Road

Trevose, Pa. 19047

215-357-1400



CQ WW DX PHONE CONTEST

The story of 1988's
record-breaking
effort



By Mark Allen, WJ7X, National Service Manager,
Icom America, Inc.

I was taking a late night flight home from the Dayton Hamvention™ in 1988. As I settled into my seat, I saw the face of an old friend, Danny Eskenazi, K7SS, in a distant part of the sparsely occupied cabin. When I went over to say hello, I found Danny sitting with John Kiesel, KE7V.

The conversation drifted from topic to topic during the long flight, until the subject of a DXpedition came up. Danny's eyes beamed as he asked if I might be interested in lending technical support to a possible DXpedition to Aruba. Carl Cook, AI6V, had talked with Dan and several other operators about putting the DXpedition together in an attempt to win the 1988 CQ Worldwide DX Phone Contest.

The idea appealed to me greatly; however, my skills as a contest operator were minimal. I thought the DXpedition might be a good vehicle to get back into the contesting scene.

The remainder of the flight was occupied with talk about the most efficient way to beat our competition from both technical and operating standpoints. As I listened, I realized that I had fallen years behind the other operators in contesting.

About the time my enthusiasm reached its peak, I was

informed that Carl was going to run the operation on a "by invitation only" basis. Getting an invitation was going to be difficult, unless I had something specific to contribute. My contribution would

definitely have to be my technical skills. As we left the plane in Seattle, Dan assured me that he would see what he could do.

Carl called a few days later. He said there was a rumor circulating that I was interested in getting involved in his planned Aruba DXpedition. Without the slightest hesitation, I told him "absolutely."

After a brief rundown of my technical background, Carl decided that it would be a good idea to have me along. Although I didn't realize it, my 20-year ham radio career was about to change dramatically.

Carl immediately put me to work on a series of challenging technical questions. He asked if I realized the range of the problems caused when six stations were operating simultaneously in a confined geographic area. I have had quite a bit of experience in this type of situation and an extensive career in the broadcast industry, so I was very familiar with the problems. However, I had never encountered anything of this magnitude. Carl decided that because I had experience in the Caribbean and Bahamas, I would also be a good person to coordinate our equipment shipments from the United States to Aruba.

Over the next several months, the scope of the project changed considerably. Carl recruited Evelyn Garrison, WS7A, to develop the concept of a **TEAM ICOM**. ICOM would pro-

vide equipment for the effort and make transportation arrangements. In a meeting held shortly thereafter, Ron Rueter, NV6Z; Daniel Handa, W7WA; John Kiesel, KE7V; Dan Eskenazi, K7SS; and I had our first discussions about the exact types of equipment and station layouts we were going to use.

Although I didn't know it at the time, Murphy's Law was about to complicate our plans.

Our equipment list included: two IC-781s, three IC-761s, two IC-751As, seven IC-735s, four IC-12AT handi-talkies, power supplies, microphones, and various other accessories. We spent the next month drawing layout diagrams for each station, required antenna configurations, bandpass and band cutoff filters, and calculating the amount of coax cable and rope we'd need. Carl was a great help to us since he had coordinated such operations before and was familiar with the field problems involved in erecting massive numbers of antennas. At the last minute, Dick Ehrhorn, W4ETO, of ETO Alpha Amplifiers, offered a loan of Alpha 86 amplifiers. The group was very happy about this addition; it would add another couple of dB to our signal.

The logistics

By July 1, 1988, things were beginning to happen. Hundreds of hours had been invested in the project for planning, drawing, replanning, and computer analysis. It was at this time that I had my first contact with Tom Schiller, N6BT, whose area of expertise is antennas. His prowess at optimizing antennas absolutely amazed me! Tom and I had several discussions, and he ran a computer optimizing program to find the best antenna configurations.

Finally, the time came to find a place to collect all our equipment. We had amplifiers, radios, tower sections, cable, rope, and antennas. John Lopez of International Radio Systems in Miami graciously loaned us a warehouse facility. During July and August quite a bit of material arrived at John's warehouse.

In the meantime, the activity at ICOM continued at a frantic pace. All the equipment being sent to Aruba was new. First it was functionally checked for "infant" failure problems. ICOM's HF technician Russell Dudley, KW5O, coordinated this effort. Every conceivable parameter was checked on the 781s, 761s, 751As, and 735s. I began assembling spare parts kits, which included service manuals, owner's manuals, and parts that wouldn't be available in the field.

Although I didn't know it at the time, Murphy's Law was about to complicate our plans.

I had contacted a freight-forwarding service in Miami and had been assured that equipment transportation to and from Aruba would be no problem. Their planes, they said, flew to the island on a daily basis taking supplies to the hotels and casinos. It was here that I made my first mistake. Assuming that anyone who transported casino and hotel supplies should surely be well connected, I didn't do any serious checking. Boy, was I ever wrong!

Around the middle of August, I called Dick Ehrhorn, W4ETO. He informed me that all the amplifiers had been checked, rechecked, and shipped to our collection point in Miami. I also confirmed that all the tower materials, antennas, rope, and coax cable had also been shipped. ICOM shipped their equipment, and the whole project was in the hands of the trucking companies and UPS.

By September 1st, all the equipment had reached Miami

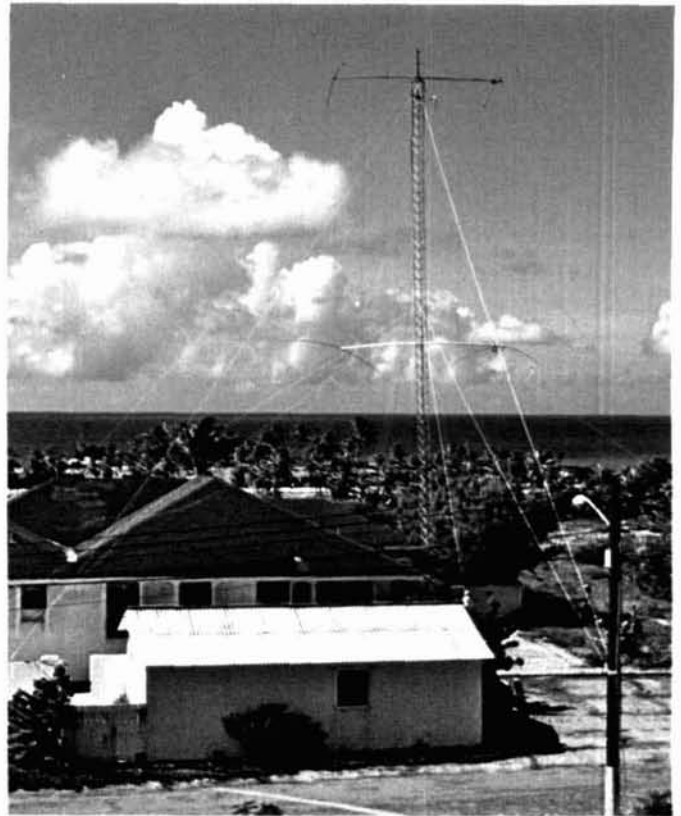

and was being prepared for shipment to Aruba. There was not the slightest hint of trouble.

After extensive consultations with the Miami freight company, it was determined that the equipment needed to arrive by October 15th; the nominal shipping time to the island of Aruba was three or four days. We were told: "No problem." Murphy laughed at our ignorance.

A small setback

On Monday October 17th, I received a panicked call from Carl. He was in Aruba, but there was no equipment waiting.

The first call to the freight company indicated that the equipment had been picked up, shipped, and was in Aruba. Carl spent the remainder of the 17th and most of the 18th trying to locate it. Finally, after scouring customs, the air freight office, and the island, he determined that the equipment was just not there. Another call was made to the freight company. They were absolutely sure the equipment had been shipped and had flight and waybill numbers to prove it. Carl spent most of the 19th and 20th of October calling from Aruba, trying to locate the shipment.

Meanwhile, Hurricane Gilbert was lashing the islands of Bonaire and Curaco, and there were heavy rains and stray winds on Aruba. Time was rapidly running out. The entire crew was due on Monday the 24th to begin assembling the station and raising towers and antennas. Unfortunately, there was nothing for them to raise.

Late on Thursday October 20th, Carl determined that the freight had been shipped on the 19th. However, it had been sent to Curaco instead of Aruba. It seemed that the air-freight company was temporarily banned from landing in Aruba.

On Friday the 21st, we discovered that the freight agent in Curaco handling our shipment was an Amateur operator. Carl pleaded with him and explained the problems we were having. Magically, the brotherhood of Amateur Radio came

ICOM

IC-765 HF Transceiver



MAKE YOUR DREAMS A REALITY!

ICOM incorporated your most requested features with modern technology's best designs to produce the remarkable IC-765 dream rig. Its combination of excellent performance and superb reliability truly open a new dimension in HF operating enjoyment.

THE HF FOR TODAY'S ACTIVE AMATEUR.

Includes: ***Band Stacking Registers.** Each band's VFO's retain the last selected frequency, mode and filter choice when changing bands. Produces the equivalent of 20 VFO's; two per band. Great for multiband DX'ing! ***99 Fully Tunable Memories.** Store frequency, mode and filter selections. Each one can be returned and/or reprogrammed independent of VFO operations. Memories 90-99 also store split Tx/Rx frequencies. ***10Hz Readout.** Perfect on-the-dot frequency selection for nets, DX skeds and data communication modes. ***Full QSK Break-in.** For super CW operations!

*Direct Digital Synthesizer (DDS).

Assures ultra-fast PLL switching and lock-in for excellent PACKET and AMTOR operations.

***Maximum Operation Flexibility!** The three step attenuator cuts multi-station overloads. ***Built-in AC Supply.** The IC-765 is 100 percent duty cycle rated for cool operation and superb performance on all modes! ***Fully Automatic Antenna Tuner.** With built-in CPU and memory for extremely fast tuning and one-touch operation. Wide tuning range. ***CW Pitch Control.** Total operating comfort and convenience for successful contesting and DX'ing. An iambic keyer with adjustable speed and weight is also built into the IC-765! ICOM also included ***Narrow 500Hz CW**

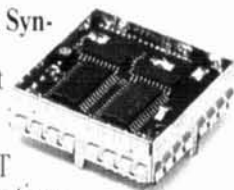

Filters. The FL-32A and FL-52A deliver razor sharp selectivity. A serious DX'er's delight! 250Hz FL-53A and FL-101 optional.

The IC-765 **General Coverage Receiver** covers all bands, all modes and is backed by ICOM's full one-year warranty at any one of our four North American Service Centers. The IC-765 turns your dreams into reality!

ICOM

First in Communications

ICOM America, Inc., 2380-116th Ave. N.E., Bellevue, WA 98004
Customer Service Hotline (206) 454-7619
3150 Premier Drive, Suite 126, Irving, TX 75063
1777 Phoenix Parkway, Suite 201, Atlanta, GA 30349
ICOM CANADA, A Division of ICOM America, Inc., 3071 -
#5 Road, Unit 9, Richmond, B.C. V6X 2T4 Canada
All stated specifications are subject to change without notice or obligation. All ICOM
radios significantly exceed FCC regulations limiting spurious emissions. 765429

together. The shipment began arriving on the 22nd. The majority of it was in place by the 24th. Unfortunately, we discovered that we were still missing all of the antennas. We began working our way backwards and finally discovered that the antennas inadvertently had not been shipped from Miami. We made a hasty call to American Airlines air freight and they arrived on the 26th. We went to work building antennas the instant Carl drove in from the airport. Although we had built the towers on the 25th and 26th, we didn't actually get to put up the antennas until late Wednesday. Antenna erection continued throughout the day on Thursday and finished the morning of Friday the 28th, with the contest a mere twelve hours away! I left Seattle on the 24th, planning to land in Aruba later that night.

When I arrived, I found that the shipment had finally made it. Most of the equipment had been removed from its shipping containers and checked. Aside from a minor ding to an amplifier, the equipment had reached its destination in good condition — despite its detour!

The work proceeds

Meanwhile, all our technical plans were falling into place. There were two houses a short distance apart. We decided that the 10, 15, and 20-meter activities would be headquartered at one house. The Forty, 80, and 160 meters would be



at the other, which had a large open field that we would use for our Beverage antennas.

Two 781s were assigned to the 40 and 80-meter positions; the 160-meter position had one 751A, and three 761s covered 10, 15, and 20 meters. The 735s were used parallel to each position for spotting radios. They were connected via a relay network so the spotter operator could take control of the amplifier and antenna to grab a rare contact.

The antenna system generally consisted of four-over-four stacks on 10, 15, and 20 meters. The lower antennas were fixed and connected via a phasing harness to the upper, rotatable antenna. Stacked two-element beams were used in the same configuration on 40 meters. The antennas for 80 and 160 meters were pure magic! Wally Eckles, W8LRL, noted low-band DXer, appeared on Wednesday with the supplies to build the 80 and 160-meter antennas.

Wally proceeded to construct one of the largest low-band Beverage arrays I had ever seen! The transmitting antennas were an array of long wires, slopers, and a vertical made out of pipe borrowed from a local refinery. Stringing out the wires for the Beverage was an interesting experience. We traipsed through coral fields, slightly overgrown with underbrush and overrun with small iguanas. The ground around us moved continuously, as the lizards scurried about.

After all the antennas were up, everyone began making cables. There were hundreds of PL 259s to be installed on var-

ious types of coax cable. Our low-frequency antenna construction had fallen behind schedule. Consequently, the 160 station didn't get on the air until several hours into the contest. Station after station was falling together when, all of a sudden, Murphy struck again!

What we thought was going to be a simple licensing procedure for our operations became a total nightmare. Problems with the local telecommunications agency necessitated going all the way to the Minister of Telecommunications. The Minister, a most gracious gentleman, expedited our paperwork at an unbelievable pace. He assigned his assistant to take care of our needs, and though we had gotten off to a slightly rocky start with the local government, our P40 licenses came through at the last possible minute.



After all the months of planning, hundreds and hundreds of hours of work, and monumental expense, the contest was on!



We spent Friday the 28th cautiously tuning up amplifiers and radios. Amazingly enough, everything worked! The antennas performed as well as (and in some cases, better) than we expected. We keyed up transmitters at each location, to check our power requirements and to see if the AC wiring in the residences would stand the load. We found no problems with the AC power in either the HF or the LF house.

As Friday continued, everyone performed extensive equipment checks and rechecks. I found myself running from pro-

ICOM**IC-4KL**

GIVE YOUR SIGNAL A BOOST!!!

ICOM's all new IC-4KL solid state HF linear amplifier represents a hefty step forward in modern electronic technology and futuristic station design.

It installs in a limited space, interconnects in a breeze and delivers band-commanding performance in the most reliable top-of-the-line fashion. Give your signal a power boost with ICOM's IC-4KL!

GLOBE SPANNING POWER.

The rugged IC-4KL delivers 1000 watts output with full 100 percent duty cycle.

Covers 160-15 meters. A power boost that will be heard around the world!

ALL SOLID STATE AND FULLY AUTOMATIC.

No lethal high voltages required. No warm-up, no tune-up, no fumbles. Fully automatic and overload-protected. Just switch on and operate. Follows band selections on your ICOM transceiver. Add ICOM's optional EX-627 and setup even selects the proper antenna. The ultimate HF amplifier!

AUTOMATIC ANTENNA TUNER BUILT-IN.

Advanced design and wide impedance matching range. Internal CPU stores previous settings on each band for rapid single-button operation. Automatically seeks for and memorizes new settings if SWR changes or antennas are swapped.

FULL CW BREAK-IN.

The IC-4KL uses extremely quiet and high speed relays. A DX'er's winning edge and a Packeteer's delight!

UNIQUE MODERN DESIGN.

Husky RF/PS unit rolls conveniently under desk or into nearby corner. All you see is a small remote control featuring dual multi-functioned meters for SWR and output watts.

The IC-4KL comes complete with a remote control unit, RF/PS deck and nine feet of interconnecting cable for easy installation. The IC-4KL... Big Signal Performance backed by a one-year warranty at any one of ICOM's four North American Service Centers.

ICOM America, Inc. 2380-116th Ave. N.E. Bellevue WA 98004
Customer Service Hotline (206) 454-7619
3150 Premier Drive, Suite 126, Irving, TX 75063 1777 Phoenix Parkway, Suite 201
Atlanta, GA 30349 ICOM CANADA, A Division of ICOM America, Inc.
3071 - #5 Road, Unit 9, Richmond, B.C. V6X 2T4 Canada
All stated specifications are subject to change without notice or obligation. All ICOM
radios significantly exceed FCC regulations limiting spurious emissions. 4KL689

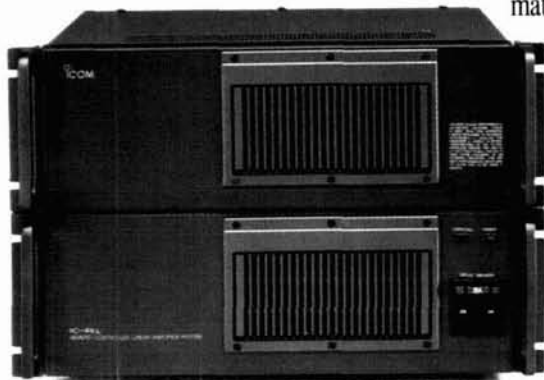

ICOM
First in Communications

ject to project, taking care of problems with flip switches, headset wiring, digital voice keyers, and every other aspect of the operation. Since this was a group of the world's finest operators, I was hardly about to question why each one of them needed a different kind of headset. There were as many different headsets, microphones, and keyer arrangements as there were operators. Contest time was now just six hours away. I was still frantically putting PL-259s on coax for short jumpers, rechecking the tuning on amplifiers and interfacing headsets.

We began our final on-the-air testing late in the afternoon of October 28th around 2200 Z. With one exception, all was operating well. Our 160 antenna was still under construction. W8LRL was hard at work building an antenna tuner to replace one that accidentally got left behind.

The contest

By now, blood pressure readings for the first shift of operators were far above safe levels. Everyone and everything was ready to go. It was hard to believe the contest was finally beginning. After all the months of planning, hundreds and hundreds of hours of work, and monumental expense, the contest was on!

Approximately two hours into the contest, the 160-meter antenna problems were resolved, and the 160 station got on the air. Dick, W4ETO, and I continually monitored the heartbeat of the system. Dick kept an eye on the Ehrhorn amplifiers, and I watched all the ICOM equipment and peripheral devices.

Dick and I crossed paths when the contest was about six hours along. We discovered, to our excitement, that neither of us was having any equipment problems. We were amazed that everything was working; all the equipment was talking, but not to each other! We attributed the success to good equipment and excellent planning.

I finally closed my eyes around 3:00 a.m. Saturday morning, only to be awakened at 4:30 a.m. by Tom, N6BT, the on-the-air coordinating officer. He told me that the 15-meter station was down and nobody could figure out what was wrong with it. Ron Rueter, NV6Z, met me at the 15-meter position. It took two and a half minutes of troubleshooting to determine that a coax line was open. We replaced it quickly with a spare line, and 15 was back on the air. The total downtime was about six minutes. This was the only failure of any item during the contest.

By noon Sunday we hoped that the equipment would continue to operate without failure. Tom was passing out some promising information. Scores were stacking up impressively; they were even higher than we had expected. As each hour passed, the chances of Murphy striking again were reduced by several orders of magnitude. It was apparent that we were closing in on a new world's record. We had had a small rain shower and I nervously watched Bird watt meters for reflected power. I was sure that many of the outside connections were untaped — although we had tried to tape each of them.

I'd been so busy keeping an eye on all the equipment that I hadn't noticed that the support crew had put champagne on ice. This was a good indication they knew something that I didn't. I made a quick check with N6BT; our score was running well above what we expected.

Finally, it was over; it was hard to believe. We had run the whole weekend without any equipment failure. There was much nervous talk about the exact status of our final score and our standing in the contest.

By Tuesday many of the operators had returned home; they had all been on tight vacation schedules. This left about five of us to disassemble and pack. Before we got started, we got word that ICOM was willing to sponsor the group for the CW contest that was coming in several weeks. With that news in mind, we took down the low-band station equipment and all but two operating stations of the high-band station and put them in storage.

All too soon it was time to leave and head back home. Eight months of planning and hundreds of hours of effort had paid off. As I stepped onto the plane to leave P40 land, I realized that I had been part of a world-champion DX team — a claim very few operators can make!

The final score, after all was checked and duped, was 54,864,040 points. This should surpass the old world's record by 12,906,796!

I realized that I had been part of a world-champion DX team — a claim very few operators can make!



A successful contest formula

Frequently, I'm asked what single element played the most important part in the success of the DXpedition. The answer is planning and teamwork. The effort could not have been successful without extensive planning. Also, if all the members of the team had not worked so well together, the venture would have failed.

I'm also asked how much equipment I took to do the installation and maintain the station on the air during the contest. I took my old faithful Bird watt meter with a full selection of elements, a set of hand tools, large and small soldering irons, a logic analyzer and a multimeter. I'd advise future DXpedition organizers to have operators submit itemized lists of the equipment they bring, in addition to marking each item with their name or callsign. Each of our operators was asked to bring such things as coax relays, keyers, headphones, and individual operating accessories. Consequently, we had quite a problem making sure everyone got back what they brought as we disassembled the station.

The attitude of our entire group during this DXpedition is best summed up by the saying on the license plates on the small, friendly island of Aruba. It says, "One happy island." We maintained our sense of humor and optimism during the long hours of planning, setup, and the contest itself. And the results paid off. 

ICOM

IC-781 HF Transceiver



THE FUTURE OF AMATEUR COMMUNICATIONS

Once in a lifetime, a transceiver is introduced that's so extraordinary and innovative that it opens a totally new era in HF communications. ICOM's pacesetter IC-781 proudly exhibits that hallmark achievement with futuristic designs and features of true legendary proportions. Whether DX'ing, contesting, pioneering new interests or enjoying unquestionable top-of-the-line performance, the IC-781 is indeed today's standard of excellence!

Multi-Function Five Inch CRT. Displays frequencies, modes, memory contents, operating notes, RIT, two menu screens, plus a panoramic view of all signals in a selected range. A portion of the screen also serves as a display for data modes like RTTY, AMTOR, and PACKET.



Unique Spectrum Scope. Continuously indicates all signal activities and DX pileups with your operating frequency in the center. Selectable horizontal frequency spans of 50,

100, and 200kHz for each side of the frequency you're listening to. Vertical range indicates relative signal strengths. A contesteer's dream!



Dual Width Noise Blanker includes MCF filter plus level and width controls to eliminate pulse and woodpecker noise with minimum adjacent-signal interference.

Incomparable Filter Flexibility. Independent selection of wide and narrow SSB filters plus CW filters. Second and third CW IF filters are independently selectable!

Dual Watch. Simultaneously receives two frequencies in the same band! Balance control adjusts VFO A/B receive strength levels. You can check additional band activity, even tune in your next contact, while in QSO without missing a single word!

DX Rated! 150 watts of exceptionally clean RF output. Easily drives big amplifiers to maximum power.

Twin Passband Tuning with separate controls for second and third IF stages! Increases selectivity and narrows bandwidth, independently varies low and high frequency response, or functions as IF shift. It's DX'ing Dynamite!

A Total Communications System! Includes built-in 100% duty AC supply, high speed automatic antenna tuner, iambic keyer, semi-automatic or full QSK CW break-in to 60 wpm, Audio Peaking Filter (APF), RF speech processor, multiscanning, 105dB dynamic range, all-band/all-mode receiver with general coverage, and much more!

ICOM Dependability. The phenomenal IC-781 is built for action and backed with the most extensive warranty in the industry.

See the IC-781 at your local ICOM dealer.

ICOM

First in Communications

ICOM America, Inc., 2380 116th Avenue N.E., Bellevue, WA 98004
 Customer Service Hotline (206) 454-7619
 3150 Premier Drive, Suite 126, Irving, TX 75063
 1777 Phoenix Parkway, Suite 201, Atlanta, GA 30349
 ICOM CANADA, A Division of ICOM America, Inc.,
 3071 - #5 Road, Unit 9, Richmond, B.C. V6X 2T4
 All stated specifications subject to change without notice or obligation.
 All ICOM radios significantly exceed FCC regulations limiting spurious emissions. 781188.



CQ WORLDWIDE SSB DX CONTEST

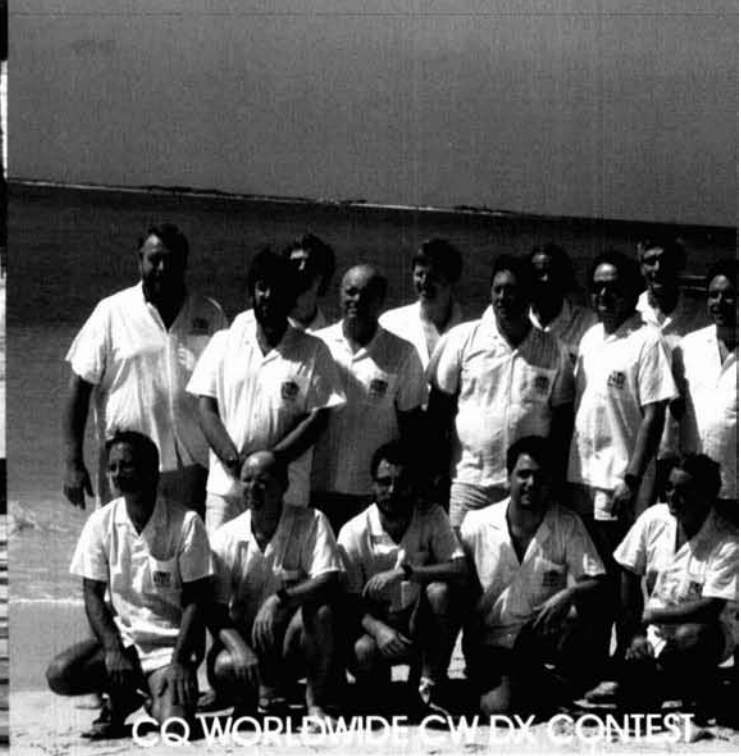

CQ WORLDWIDE CW DX CONTEST

WINNING THE WORLD OVER!

Over 50 million points and 20,000 SSB contacts in 48 hours. That's what TEAM ICOM's operation from Aruba/P40V achieved during the 1988 CQ DX Contest setting a new all-time world record. Their incredible CW performance four weeks later was an overwhelming success... P40V's combined scores resulted in the highest SSB/CW contest score ever recorded!

Unbelievable? Not really. They used ICOM HF transceivers, the finest quality and most reliable radios available today.



"The ICOM radios performed flawlessly. It was a thrill to operate with such a great group of contesters. My thanks goes to each and every one of them and to ICOM for helping make it possible." Carl Cook, AI6V

"The IC-781 is a great radio, especially for split operation on 75 meters. It's easy to use. I liked the IC-761 so much I'm buying one." Dale Green, VE7SV

TEAM ICOM's record-setting operation was supported by the same IC-781 and IC-735 HF transceivers chosen by leading contesters and DX'ers around the world. Their demands for high intermod immunity, low noise reception and superior transmitted signal quality are standard design features incorporated in all ICOM HF transceivers, including the new IC-765 and IC-725. Naturally, all ICOM HF transceivers are confidently backed with a one-year full service warranty! ICOM: Winning the World Over!



P40V

TEAM ICOM

ICOM America, Inc. 2380-116th Ave. N.E., Bellevue, WA 98004
Customer Service Hotline (206) 454-7619
 3150 Premier Drive, Suite 126, Irving, TX 75063 /
 1777 Phoenix Parkway, Suite 201, Atlanta, GA 30349
 ICOM CANADA, A Division of ICOM America, Inc.,
 3071 - #5 Road, Unit 9, Richmond, B.C. V6X 2T4 Canada
 All stated specifications are subject to change without notice or
 obligation. ARUBA389

SUBSCRIBE

AND RENEW

TOLL-FREE

HAM RADIO



1 YR - \$22.95

2YRS - \$38.95

3 YRS - \$49.95

Prices U.S. only



MASTERCARD



VISA BILL ME

Please have your charge card ready.

DATATEL 800™

800-341-1522

Weekdays 8 AM - 9 PM EST

Saturdays 9 AM - 5 PM EST

IN MAINE CALL COLLECT (207) 236-2896

OUR 800 NUMBER IS FOR SUBSCRIPTION ORDERS ONLY!

For Errors or Change of Address

CALL *ham radio* direct at
(603) 878-1441 8-5 EST

New From **ORION**



THE ROTATOR!

OR-2300 (Prototype shown)

Introducing a new generation in rotators!
Orion's intense research and development has produced a rotator for today and into the Twenty First Century.

HIGH PERFORMANCE FEATURES

- Proven Worm Gear Drive
- Compact—Fits Popular Towers
- Flex-Mount
- Built-In Thrust Bearing
- Massive Mast Clamps
- Standard Hole Pattern
- Self-Centering Guide
- Stainless Steel Hardware
- Made In U.S.A.
- 1 Year Warranty
- 35 Square Feet
- Easy Reading Control Box
AND MORE!

**For More Details Contact Your
Local Dealer Or Orion**



**ORION
BUSINESS
INTERNATIONAL, INC.**
TM

P.O. Box 9577

Canoga Park, CA 91309

U.S.A.

Tel: (818) 888-4927

Fax: (818) 888-5112

Telex: 697-4899

Ham Radio Techniques

Bill Orr, W6SAI

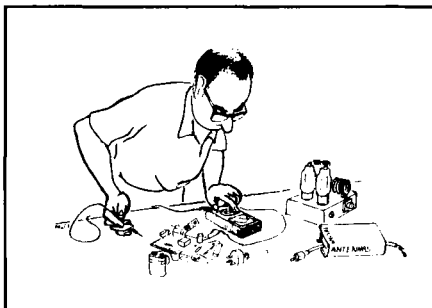

THE GAMMA MATCH: AN UPDATE

When the 88 to 108-MHz FM broadcast band was authorized shortly after World War II, a VHF transmitting antenna using an off-center feed system was introduced. Adapted for Amateur use, the system was termed the "gamma match" and was featured in *QST*, September 1949. The builder, H. Washburn, W3MTE, remarked that the device worked well, permitting him to achieve an SWR value as low as 1.75:1. His arrangement is shown in Figure 1.

Several other antenna experimenters and I worked with the W3MTE gamma match. We soon determined that to lower the SWR appreciably below 2:1 a variable capacitor had to be placed in series with the gamma rod (see Figure 2).

Little information was available on optimum rod-to-antenna spacing, rod length, or rod diameter. It was strictly a cut-and-try situation. Some Amateurs had good luck with the device; others couldn't get it to work. The gamma match soon got the reputation as a tricky device that was hard to adjust. In time, it became apparent that the gamma rod had to be small in diameter compared with the driven element, and that the spacing of the gamma rod to the element had to be quite large compared with rod diameter, in order to make the system work properly.

Some attempts were made to analyze the gamma match using transmission line equations. But it wasn't until Harold Tolles, W7ITB, analyzed the device¹ that a computer program was derived that would predict gamma dimensions accurately for a particular antenna.²

The gamma match program

The gamma program, written in BASIC by Richard Nelson, WBØIKN, is

based upon W7ITB's analysis and designed for the Apple II+. It can be modified to work equally well with many microcomputers.³

I put the program to use designing a gamma match for a three-element, 10-meter Yagi. I took beam dimensions from my *Beam Antenna Handbook*.⁴

Design frequency was 28.5 MHz. I planned to use a 1-inch diameter element, a 1/4-inch diameter gamma rod, 3-inch center-to-center spacing, and a 100-pF series capacitor (refer to Figure 3). Feedpoint impedance was estimated to be 18 ohms and I wanted to match to a 50-ohm line. When I plugged these values into the computer program, it indicated a gamma rod length of 22 inches and a series capacitance of 180 pF.

These results immediately rang an alarm bell. Our experiments had indicated that the series gamma capacitor should be about six times the operating frequency in meters and the gamma rod

FIGURE 1

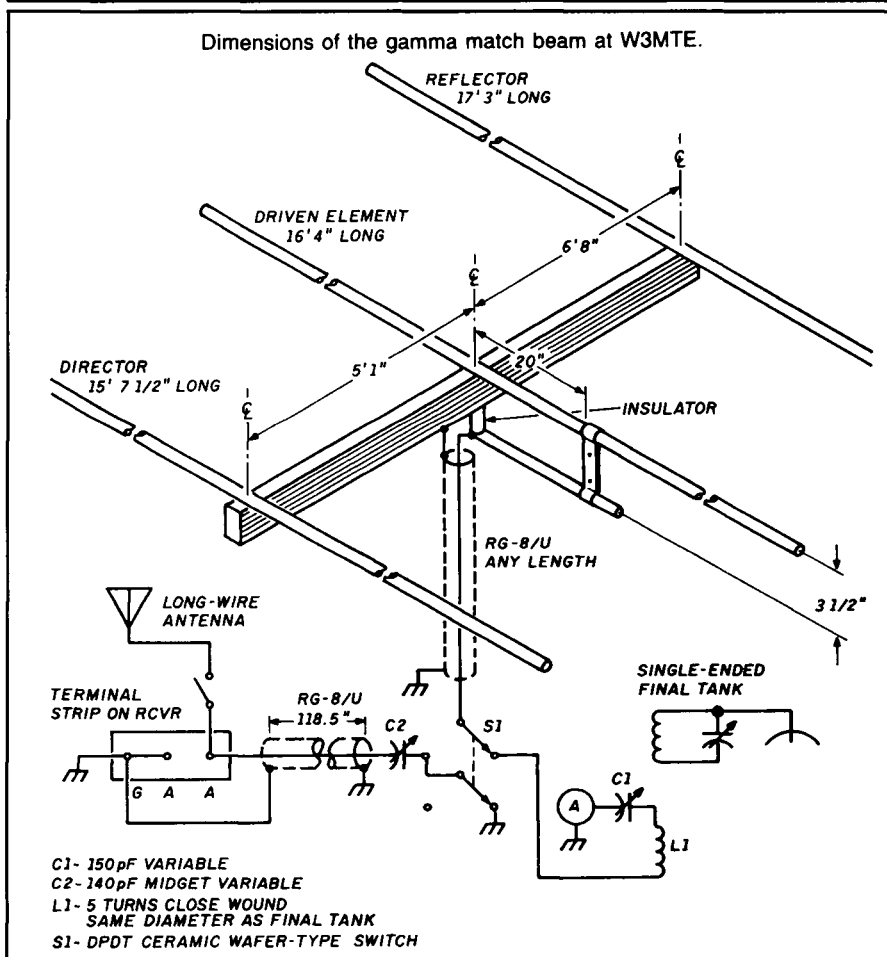

The early gamma match described by W3MTE (*QST*, September 1948).

FIGURE 2

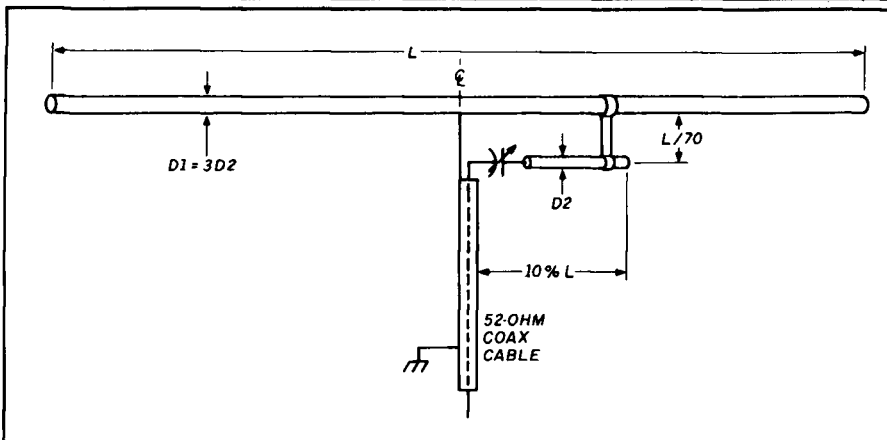

Early Radio Handbook shows series gamma capacitor and approximate dimensions for gamma match.

FIGURE 3

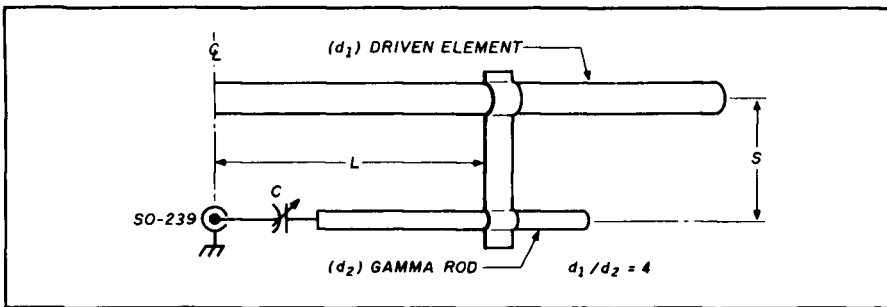

W6SAI's 10-meter gamma match. Diameter d_1 = one inch, d_2 = 1/4 inch. Center-to-center spacing = 3 inches.

should be about 0.04 wavelength long. For the 10-meter band, this works out to a capacitor of 60 pF and a rod length of about 16 inches. To back up my assumption, I found a commercially produced 10-meter beam with substantially the same dimensions as my design, using a 19-inch gamma rod and a 45-pF capacitor. Not too close, but a lot closer than the answer ground out by the computer program!

Obviously, there was some factor I hadn't taken into account that influenced gamma dimensions. There was more to the gamma match than met the eye!

Gamma match computation

I found the answer to the puzzle in a short remark (almost an afterthought) in the text of the W7ITB computer program article.¹ Harold worked out gamma dimensions for a sample antenna and then mentioned that if the drive point impedance of the antenna had capacitive reactance, the value of the gamma capacitor would decrease, as would the length of the gamma rod. Armed with

this morsel of information, I read the WBØIKN computer program again. At the end of the article the author mentioned that a smaller gamma capacitor may be used if radiator reactance is made capacitive (negative) by reducing its overall length.

Aha! Here was the missing clue. With a given value of drive point resistance, and a given gamma to driven element spacing, what would happen to the rod length and series capacitance values when different amounts of negative reactance were introduced into the driven element?

Varying the driven element reactance

For a given frequency, an antenna element may exhibit either positive or negative reactance at its drive point when the antenna is simply made longer or shorter than the resonant length. Shortening the element produces negative reactance; that's what I was interested in! I reran the WBØIKN program, plugging in various

NEW! No Tune Microwave Linear Converters

Board level RX/TX transverter modules and local oscillator: kit or assembled/tested. Linear operation allows all modes, ATV, SSB, Digital, Packet, FM.

Available for: 903, 1269, 1296, 2304, 3456 MHz

COMPLETE KITS

SHF 900 K	with integral LO for 902 MHz	\$110
SHF 1240 K	for 1240-1300 MHz - specify 1269 or 1296 base	\$135
SHF 2304 K	for 2300-2450 MHz - MODE S downlink package available	\$185
SHF 3456 K	for 3456 MHz	\$185
SHF-LO	LO kit only, with XTL, 540-580 MHz, +10 - +14 dBm out	\$ 60

Call or write for details on complete transverters and options

SHF Systems
P.O. Box 666
Nashua, NH 03061
(603) 673-1973
John Molnar, WA9ETD



Down East Microwave
Box 2310, RR#1
Troy, ME 04987
(207) 948-3741
Bill Olson, W3HQZ

✓ 136

DOWN EAST MICROWAVE



MICROWAVE ANTENNAS AND EQUIPMENT

- Loop Yagis • Power Dividers • Linear Amplifiers • Complete Arrays • Microwave Transverters • GaAs FET Preamps
- TROPO • EME • Weak Signal • OSCAR • 902 • 1269 • 1296 • 2304 • 2400 • 3456 MHz
- 2345 LY 45el loop Yagi 1296 MHz 20dBi \$99
- 1345 LY 45el loop Yagi 2304 MHz 20dBi \$80
- 3333 LY 33el loop Yagi 902 MHz 18.5dBi \$99

Above antennas assembled and tested. Kits available.

Add \$8 UPS S/H, \$11 West of the Mississippi

MICROWAVE LINEAR AMPLIFIERS SSB, ATV, REPEATER, OSCAR

2316 PA	1w in 18w out	1240-1300 MHz	13.8V	\$265
2335 PA	10w in 35w out	1240-1300 MHz	13.8V	\$315
3318 PA	1w in 20w out	900-930 MHz	13.8V	\$265
3335 PA	10w in 40w out	900-930 MHz	13.8V	\$320
23LNA preamp	0.7dB N.F.	1296 MHz		\$ 90
33LNA preamp	0.9dB N.F.	902 MHz		\$ 90

Add \$5 shipping UPS/48

LMW 1296 & 2304 MHz transverter/kits in stock

Write for free catalog



DOWN EAST MICROWAVE
Bill Olson, W3HQZ
Box 2310, RR 1, Troy, ME 04987
(207) 948-3741



✓ 137

MOVING?

Let circulation know
60 days in advance.

Ham Radio
Greenville, NH 03048-0498
603-878-1441

values of negative reactance from $j=0$ to $j=-50$ (see Figure 4).

The plot shows that the series capacitance value peaks at the element resonant frequency ($j=0$) and decreases in value either side of resonance. The length of the gamma rod, however, follows a different curve. It exhibits the shortest length when the antenna exhibits negative reactance ($-j15$).

A practical gamma match system (one that can be built cheaply and adjusted easily) calls for the shortest gamma rod and the least amount of capacitance. It's no fun to hang from the top of a tower and try to adjust a gamma rod whose shorting bar isn't quite within reach!

You can build a small gamma capacitor inexpensively with a coaxial gamma rod that has the inner conductor serving as one capacitance element as shown in Figure 5.

In my case, a 22-inch adjustable gamma rod would work over a range of antenna reactance from $j0$ to $-j50$. However, as the antenna element approached resonance, the value of the gamma capacitance rose sharply, and the coaxial rod length didn't provide sufficient capacitance. From the plot, it was obvious that the designer of the manufactured antenna had cut his driven element shorter than resonance to provide a negative value of reactance (about $-j30$ ohms) in order to have reasonable gamma dimensions.

Gamma rod spacing

My next question was: what is the effect on gamma dimensions when element-to-rod spacing is varied? I used the computer program for the 10-meter beam element diameters; the results are summarized in Table 1. Rod length compared with spacing is given for four values of antenna reactance: $j=0$ (resonance), $j=-15$, $j=-30$ and $j=-50$ ohms.

Larger values of element-to-gamma spacing require a shorter rod length, but greater gamma capacitance. The shortest rod length is achieved when the driven element has a reactive value between $-j15$ and $-j30$, with an element-to-gamma spacing of 3 to 4 inches.

Gamma capacitance increases with element-to-gamma spacing, and decreases as the driven element exhibits greater values of negative reactance. Practical (small) values of capac-

FIGURE 4

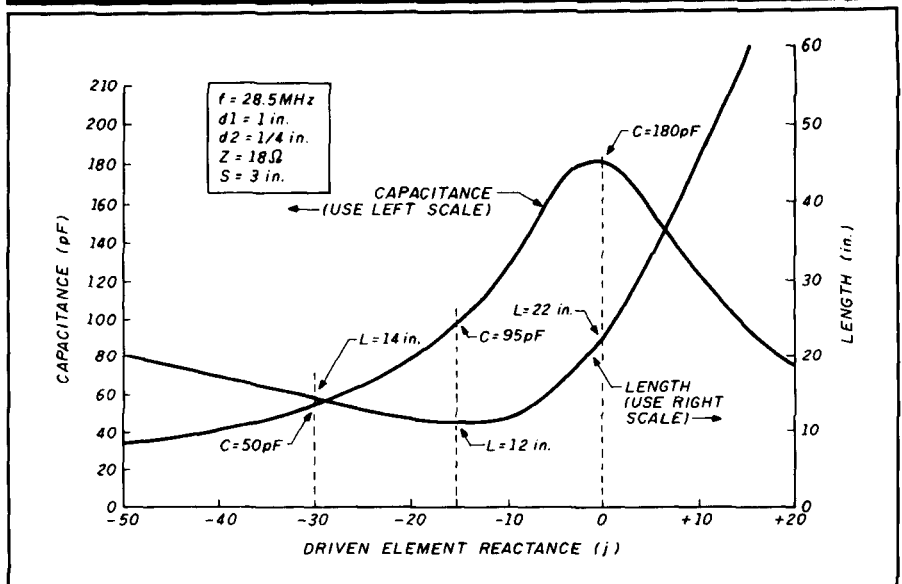

Graph for determining design lengths of the gamma match.

FIGURE 5

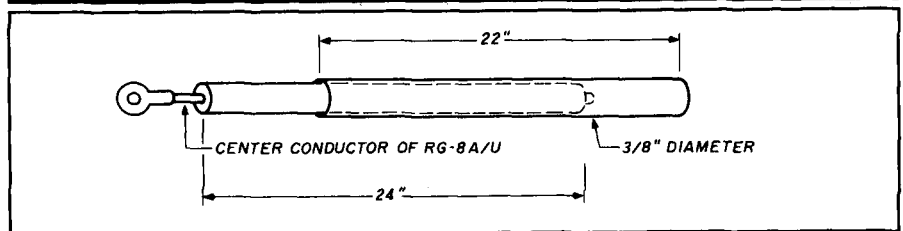

Coaxial gamma-rod capacitor for 10-meter beam. Maximum capacitance is about 55 pF.

TABLE 1

Various gamma and series capacitance values for different length driven elements.			
j	Spacing inches	Rod Length inches	Capacitance pF
j0	1	39	83
	2	25	145
	3	23	180
	4	22	212
-j15	1	33.5	57
	2	15	80
	3	12	95
	4	11	105
-j30	1	36	24
	2	18	31
	3	13	52
	4	12	58
-j50	1	36	22
	2	22	31
	3	20.5	32
	4	17	35

itance are reached in the reactive region between $-j30$ and $-j50$.

Because shortening the driven element has minimal effect on beam performance, it would be helpful to choose a

length providing a negative reactance of 30 to 50 ohms.

Element shortening

How much physical shortening is

ICOM

KENWOOD YAESU



IC-781

HF Equipment

	List	Juns
IC-781 Super Deluxe HF Rig	\$5995.00	Call \$
IC-765 New, Loaded with Features	3,149.00	Call \$
IC-735 Gen. Cvg Xcvr	1099.00	Call \$
IC-751A Gen. Cvg. Xcvr	1699.00	Call \$
IC-725 New Ultra-Compact Xcvr	949.00	Call \$
IC-575A 10m/6m Xcvr	1399.00	Call \$

Receivers

IC-R7000 25-1300 + MHz Rcvr	1199.00	Call \$
IC-R71A 100 kHz-30 MHz Rcvr	999.00	Call \$

VHF

IC-228A/H New 25/45w Mobiles	509./539.	Call \$
IC-275A/H 50/100w All Mode Base	1299./1399.	Call \$
IC-28A/H 25/45w, FM Mobiles	469./499.	Call \$
IC-2GAT, New 7w HT	429.95	Call \$
IC-25A New Micro Sized HT	419.00	Call \$
IC-900 Six Band Mobile	639.00	Call \$
IC-901 New Remote Mount Mobile	TBA	Call \$

UHF

IC-475A/H 25/75w All Modes	1399./1599.	Call \$
IC-48A FM Mobile 25w	509.00	Call \$
IC-4GAT, New 6w HT	449.95	Call \$
IC-04AT FM HT	449.00	Call \$
IC-32AT Dual Band Handheld	629.95	Call \$
IC-3210 Dual Band Mobile	739.00	Call \$
IC-2500A FM, 440/1.2 GHz Mobile	999.00	Call \$

220 MHz

IC-375A All-Mode, 25w, Base Sta.	1399.00	Call \$
IC-38A 25w FM Xcvr	489.00	Call \$
IC-37A FM Mobile 25w	499.00	Call \$

1.2 GHz

IC-12GAT Super HT	529.95	Call \$
-------------------	--------	---------



TS-940S

HF Equipment

	List	Juns
TS-940S/AT Gen. Cvg Xcvr	\$2499.95	Call \$
TS-440S/AT Gen. Cvg Xcvr	1449.95	Call \$
TS-140S Compact, Gen. Cvg Xcvr	949.95	Call \$
TS-680S HF Plus 6m Xcvr	1149.95	Call \$
TL-922A HF Amp	1749.95	Call \$

Receivers

R-5000 100 kHz-30 MHz	1049.95	Call \$
R-2000 150 kHz-30 MHz	799.95	Call \$
RZ-1 Compact Scanning Rcvr.	599.95	Call \$

VHF

TS-711A All Mode Base 25w	1059.95	Call \$
TR-751A All Mode Mobile 25w	669.95	Call \$
TM-231A Mobile 50w FM	459.95	Call \$
TH-215A, 2m HT Has It All	399.95	Call \$
TH-25AT 5w Pocket HT NEW	369.95	Call \$
TM-721A 2m/70cm, FM, Mobile	729.95	Call \$
TM-621 2m/220, FM, Mobile	729.95	Call \$
TM-701A 25w, 2m/440 Mobile	599.95	Call \$
TH-75A 2m/70cm HT	549.95	Call \$

UHF

TS-811A All Mode Base 25w	1,265.95	Call \$
TR-851A 25w SSB/FM	771.95	Call \$
TM-431A Compact FM 35w Mobile	469.95	Call \$
TH-45AT 5w Pocket HT NEW	389.95	Call \$
TH-55 AT 1.2 GHz HT	524.95	Call \$
TM-531A Compact 1.2 GHz Mobile	569.95	Call \$

220 MHz

TM-3530A FM 220 MHz 25w	519.95	Call \$
TM-321A Compact 25w Mobile	469.95	Call \$
TH-315A Full Featured 2.5w HT	419.95	Call \$



FT-767GX

HF Equipment

	List	Juns
FT-747 GX New Economical Performer	\$889.95	Call \$
FT-757 GX II Gen. Cvg Xcvr	1129.95	Call \$
FT-767 4 Band New	1929.00	Call \$
FL-7000 15m-160m Solid State Amp	1995.00	Call \$

Receivers

FRG-8800 150 kHz - 30 MHz	759.95	Call \$
FRG-9600 60-905 MHz	699.95	Call \$

VHF

FT-411 New 2m "Loaded" HT	399.95	Call \$
FT-212RH New 2m, 45w mobile	459.95	Call \$
FT-290R All Mode Portable	599.95	Call \$
FT-23 R/T/T Mini HT	344.95	Call \$

UHF

FT-712RH, 70cm, 35w mobile	499.95	Call \$
----------------------------	--------	---------

VHF/UHF Full Duplex

FT-736R, New All Mode, 2m/70cm	1749.95	Call \$
FEX-736-50 6m, 10w Module	259.95	Call \$
FEX-736-220 220 MHz, 25w Module	279.95	Call \$
FEX-736-1.2 1.2 GHz, 10w Module	539.95	Call \$
FT-690R MKII, 6m, All Mode, port.	569.95	Call \$

Dual Bander

FT-4700RH, 2m/440 Mobile	889.00	Call \$
FT-470 Compact 2m/70cm Mobile	559.95	Call \$

Repeaters

FTR-2410 2m Repeaters	1269.95	Call \$
FTR-5410 70cm Repeaters	1289.95	Call \$

Call For These Quality Brand Names

ALINCO ASTRON Kantronics MFJ concepts MIRAGE/KLM TE SYSTEMS

INSTANT CREDIT WITH ICOM PREFERRED CUSTOMER CARD

JUN'S ELECTRONICS
800-882-1343

FAX 213-390-4393

ICOM	ICOM
IC-47A	IC-12AT
440 MHz, 25W, Mobile	1.2 GHz FM, HT
NOW \$279.95	SALE \$339.95
List \$549.00	LIST \$473.95

KENWOOD

TM-621A	CALL
TH-315A	FOR
TM-321A	SPECIAL
TM-3530A	PRICE

LIMITED QUANTITIES

YAESU FT-311 RM
220 MHz FM Transceiver 25W/5W
List \$439.95 **NOW \$249.95**

SE HABLE ESPANOL
FREE U.P.S. CASH ORDER
(MOST ITEMS, MOST PLACES)

(213)390-8003

3919 Sepulveda Blvd.
Culver City, CA 90230

1989 U.S. CALL DIRECTORY
(on microfiche)

Call Directory - by callsign	\$8
Name Index - by last name	\$8
Geographic Index - by state/city	\$8
All three - \$20	
\$3 shipping per order	

BUCKMASTER PUBLISHING

Route 3, Box 56
Mineral, Virginia 23117
703/894-5777 visa/mc 800/282-5628

143

TEXPRO

snap-on-choke



ELIMINATES RF INTERFERENCE IN: TV sets, Radios, HI-FI, PA systems, Telephones, VCRs, Test equipment, Burglar and Fire alarms, Modems, Monitors, Computers, Radio and TV stations, etc.

EASY TO USE: fits over and snaps onto small, large and ribbon cables. No need to rewire connectors. Unique, split ferrite core design fits up to RG8U coax cables.

WORKS IN "COMMON MODE", filters current induced in the braid of shielded cables and ground wires!

Special ferrite material effective 0.5 - 200 MHz.
DOES NOT VOID EQUIPMENT WARRANTY

Available from your dealer or order direct from:

computeradio

Box 282, Pine Brook, NJ 07058
Tel: (201) 227-0712

Send personal check with order, we ship same day First Class. 30-day money back warranty. Quantity discounts.

Package of 4 chokes with inst. instructions
\$12.99
+ \$2.00 shipping

145

THE ISOTRON
COMPACT ANTENNAS FROM 160-10 METERS

**NO TUNERS!
NO RADIALS!
NO RESISTORS!
NO COMPROMISE!**

FOUR EXCELLENT REVIEWS JUST DON'T HAPPEN BY CHANCE.
CALL US FOR A FREE CATALOGUE.

*See review in Oct. 73, 1984 *Sept. 73, 1985
*March 73, 1986 *Dec. 88, CQ

BILAL COMPANY
137 Manchester Dr.
Florissant, Colo. 80816
(719) 687-0650

146

FIGURE 6

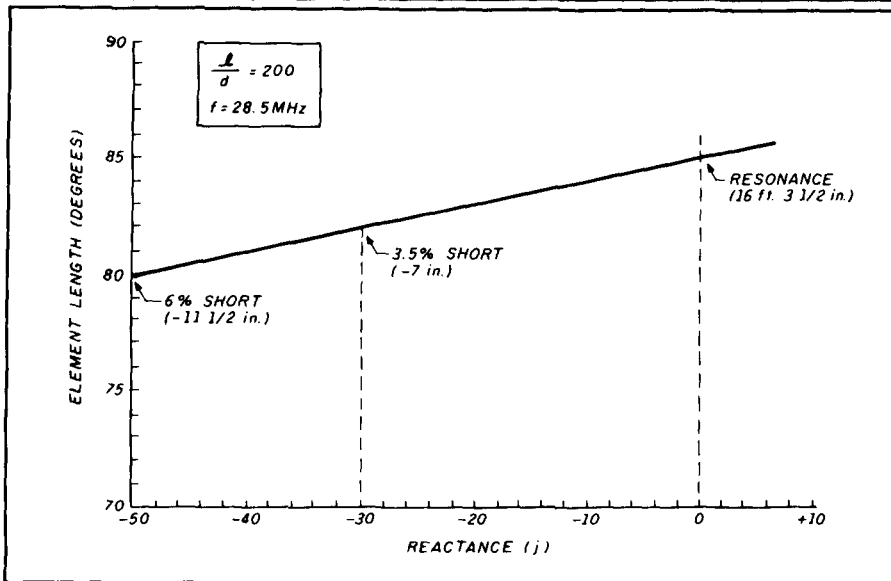

Tip-to-tip shortening required for various values of driven element reactance for 1-inch diameter element.

shows that gamma rod length increases by an inch, and that the series capacitance decreases by 3 pF from the values determined for a feedpoint value of 18 ohms. This indicates that the actual feedpoint resistance isn't critical, and that the feedpoint values given in the literature for multi-element Yagi beams hold well for use in the gamma computer program.

Gamma rod diameter

The computer program provides interesting information about gamma rod diameters (see Figures 7 and 8). The curves show the importance of having a shorter than resonant driven element. With the $-j30$ element length, gamma rod length changes less than 2 inches as the rod diameter is varied from 0.05 to 0.5 inches. The gamma capacitor, given the same rod diameters, varies from 36 to 65 pF. When the driven element is resonant, the values of rod length and series capacitance vary largely. This gives further proof that adjustment of driven element length is of paramount importance in making the gamma match work.

Frequency scaling

If all the dimensions of a 28.5-MHz beam and gamma match system are doubled, the computed results will be identical at half the frequency — or 14.25 MHz. This scaling isn't practical for my 10-meter beam; it would result in a 20-meter driven element diameter of 2 inches. I prefer a diameter of about 1.25 inches, all else being equal. I would probably also build a tapered element. The gamma match computer program doesn't consider this element, but there are programs that compute an equivalent element length for a tapered element.⁶ This equivalent element can then be used with the gamma program once its length is readjusted to provide a reactive termination. Someday the Yagi computer program will be modified for frequency scaling. It will also accommodate the gamma match, as well as other matching systems requiring adjustment of the driven element length.

Is there pattern distortion with the gamma match?

The gamma match feeds only half the driven element. What happens to voltages and currents in the other half? Does the unbalanced feed system upset the beam pattern? Tests run by

FIGURE 7

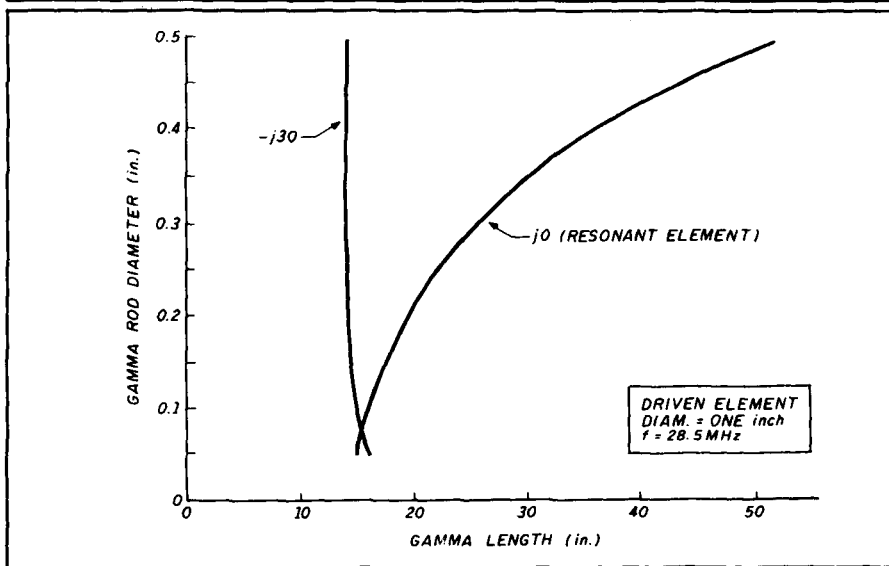

The length of the gamma rod with a shorter than resonant driven element ($-j30$) is nearly independent of gamma rod diameter.

required to provide a reactance of -30 to -50 ohms? It depends upon the ratio of element length to diameter. Such ratios have been computed and measured,⁵ and a simplified plot for a length-to-diameter ratio of 200 is shown in Figure 6. This corresponds to a 1-inch diameter element at 28.5 MHz. To achieve a reactance value of $-j30$, you must shorten the driven element about 7 inches (tip to tip). For a reactance of $-j50$, you'll need a shortening of 11.5 inches.

Drive point impedance and element length

What happens to the 18-ohm figure if the driven element has a drive point value of 18 ohms at resonance and is shortened to provide a negative reactance? It decreases in value. The reduction depends upon the amount of shortening and the element diameter, as discussed previously. Assuming that the new resistance value is 15 ohms at a reactance value of $-j50$, a computer run

Others May Try to Imitate, But...

Only One Can Be The Best



Morse Code - Baudot - ASCII - AMTOR - Packet - Facsimile - Navtex

It's a lesson you learn very early in life. Many can be good, some may be better, but only one can be the best. The PK-232 is the best multi-mode data controller you can buy.

1 Versatility

The PK-232 should be listed in the amateur radio dictionary under the word Versatile. One data controller that can receive seven digital modes, and can be used with almost every computer or data terminal. You can even monitor Navtex, the new marine weather and navigational system. Don't forget two radio ports for both VHF and HF, and a no compromise VHF/HF/CW internal modem with an eight pole bandpass filter followed by a limiter discriminator with automatic threshold control.

The internal decoding program (SIAMtm) feature can even identify different types of signals for you, including some simple types of RTTY encryption. The only software your computer needs is a terminal program.



PC Pakratt Packet TX/RX Display



Facsimile Screen Display

2 Software Support

While you can use most modem or communications programs with the PK-232, AEA has two very special packages available exclusively for the PK-232....PC Pakratt with Fax for IBM PC and compatible computers, and Com Pakratt with Fax for the Commodore 64 and 128.

Each package includes a terminal program with split screen display, QSO buffer, disk storage of received data, and printer operation, and a second program for transmission/reception and screen display of facsimile signals. The IBM programs are on 5 1/4" disk and the Commodore programs are plug-in ROM cartridges.

3 Proven Winner

No matter what computer or terminal you plan to use, the PK-232 is the best choice for a multi-mode data controller. Over 20,000 amateurs around the world have on-air tested the PK-232 for you. They, along with most major U.S. amateur magazines, have reviewed the PK-232 and found it to be a good value and excellent addition to the ham station.

No other multi-mode controller offers the features and performance of the PK-232. Don't be fooled by imitations. Ask your friends, or call the local amateur radio store. We're confident the PK-232 reputation will convince you that it's time to order your very own PK-232.

Call an authorized AEA dealer today. You deserve the best you can buy, you deserve the PK-232.

Advanced Electronic Applications, Inc.

P.O. Box C-2160
Lynnwood, WA 98036
206-775-7373

AEA Retail \$415.95

Amateur Net \$349.95

MADISON SHOPPER

CALL FOR ORDERS

1 (800) 231-3057

1 (713) 520-7300 OR 1 (713) 520-0550

TEXAS ORDERS CALL COLLECT

FAX 1 (713) 771-7759

ALL ITEMS ARE GUARANTEED OR SALES PRICE REFUNDED



New Icom IC 781

Kenwood TH215A, TH25AT

TS440 S/AT

Trades wanted

Trade in your old HT

Call



Kenwood TS 140S

New Kenwood TM 721A, mobile

ICOM 228H/TTM

Call for trade

Call

449.00



TS 790A Superior 2 Meter 70 cm Rig,

1.2 GHz Option Available

Icom 765

Kenwood MC 60A + Heil HC 5 cartridge

Icom IC 725

NYE MB5A Tuner

Alpha Delta Transtrap HV

CSI Private Patch V

Ameco PT 3 Pre Amp

Larsen 2-meter on glass

Anteco 2M, 5/8, Mag. Mount, Comp

Van Gordon Window WA2

Bird 43, elements/stock

Thousands of panel meters

Belden 9913, 8267, 8214 Stock

MICA Capacitors

Arista SWR Bridge 3-30 MHz

831SP-PL259 Silverplate (Amphenol)

82-61 N Male (Amphenol)

82-202-1006 N Male (9913)

Double Female UHF

UG176 RGBX

Surplus Elbow PL259 SO239

Receiving tubes 50-90% off list price

Santec Boom Mike/Headset (fits ICOM)

STUPH

RF Amp Meters

25 pF/10KV Doorknob Cap

Throat Mike (new mil. surplus)

ANBH 1 600 Ω Headphones (new mil. surplus)

New Demo Units for Sale

Kenwood R-5000

USED EQUIPMENT

All equipment, used, clean, with 90 day warranty and 30 day trial. Six months full trade against new equipment. Sale price refunded if not satisfied.

(800) 231-3057

POLICIES

Minimum order \$10.00. Mastercard, VISA, or C.O.D. All prices FOB Houston, except as noted. Prices subject to change without notice. Items subject to prior sale. Call anytime to check the status of your order. Texas residents add sales tax. All items full factory warranty plus Madison warranty.

Bird and Belden products in stock. Call today.

MADISON

Electronics Supply

3621 FANNIN
HOUSTON, TEXAS 77004



FIGURE 8

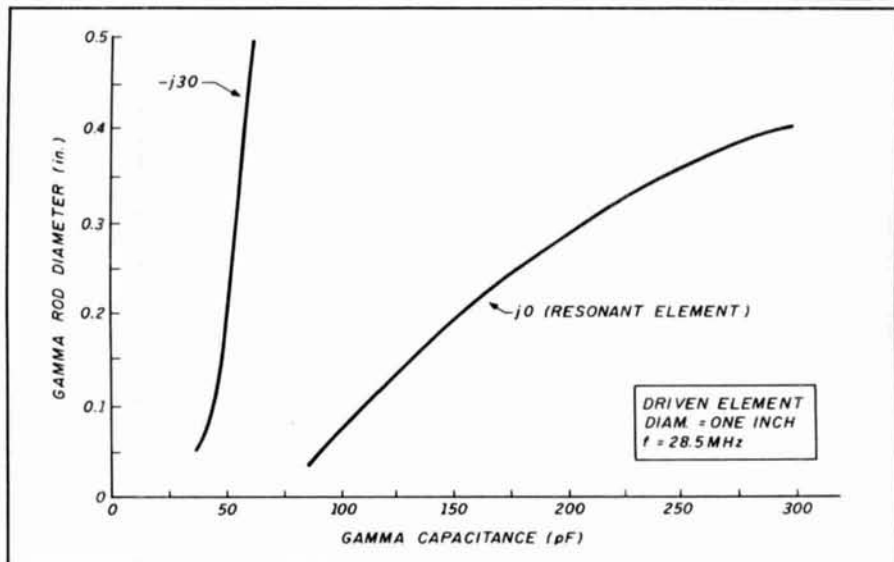

Gamma capacitance is nearly independent of gamma length when shorter than resonant driven element ($-j30$) is used.

Katashi Nose, KH6IJ, show that voltage at the driven element tips of a 20-meter Yagi isn't equal when a gamma match is used.⁷ Even so, the azimuth pattern seemed balanced. Nose concluded that the voltage imbalance wasn't important.

Later tests run by Bob Sutherland, W6PO, a VHF "moonbounce" enthusiast, on a large array of 220-MHz gamma-fed Yagis showed that the array's pattern was normal with no noticeable "squint" or distortion that could be attributed to the gamma matches.

Gamma match summary

The gamma match provides a mechanically simple and easily adjusted network for matching a Yagi to a coaxial transmission line, provided the driven element of the array is somewhat shorter than the resonant length. This point has often been overlooked or not emphasized in the literature, leading to puzzling results.

For the best mechanical arrangement, make the capacitor part of the gamma rod, as shown in Figure 5. As they say in the world of computers, the gamma match is "user friendly." Information provided in this article, along with the gamma computer program, should make life easier for those contemplating using this interesting match system.

Electric stove RFI! (What next?)

My friend Wyn Wagener, W6VQD, called me the other evening to give me the latest news on the continuing RFI battle. He was concerned about the new electric ranges.

Old-style electric stoves have a multiple circuit heating element. The circuits are selected by a rotary switch that cuts the heating coils in and out, depending upon the cooking heat required. The newer electric ranges have dispensed with this common sense idea in favor of modern gimmicks and the results are questionable, to say the least.

The new brand of electric range has only one coil in the heating element and the circuit is cycled on and off by a continuously variable heat control, instead of a multicontact switch. The control mechanism consists of a small rheostat in series with a low wattage heating element and bimetallic strip heat sensor. As you advance the control, the heater warms up and the strip cycles on and off. The strip controls the main heating element which, in turn, cycles on and off. Wyn discovered that some ovens created copious RFI during the cycling process, which can run in a sequence of 3 to 20-second on/off bursts.

Before he bought a new range for his home, Wyn took a portable receiver to the appliance store and monitored several ovens. Although there seem to

PACKET

MASTER PACKET RADIO: the hands on guide by Dave Ingraham, K4TWJ

Appeals to all levels of packet radio enthusiasts from novices to experts alike. Full of illustrations and written in a simple, easy-to-understand style. Topics covered include: a basic primer, home computers and data communications terminals, a survey of equipment available, how to set up a station plus much more. 208 pages ©1988 1st edition.

□22567 Softbound \$12.95

YOUR GATEWAY TO PACKET RADIO

by Stan Horzepa, WA1LOU

Beginners will find the complete easy-to-understand explanations eliminate many of the frustrating aspects of packet operation. Full of helpful hints and tips that come from thousands of hours of on-the-air experience. 208 pages ©1987.

□AR-PKT Softbound \$9.95

THE PACKET RADIO HANDBOOK

by Jonathan Mayo, KR3T

Providing you first with packet basics, this book progresses through the inner workings and operational aspects of packet to a look at future technology still in developmental stages. Also includes: using bulletin boards, traffic handling on packet, modulation methods and networking principles, protocols (both AX.25 and VADCG) and a thorough discussion of the various TNCs and accessories available. ©1987 1st Edition 218 pages.

□T-2722 Softbound \$14.95

ARRL COMPUTER NETWORKING CONFERENCES 1-4

Pioneer Papers on Packet Radio 1981-1985

Written during the formative years of Packet development, these papers (too numerous to mention them all) cover: theory, practical applications, protocols, software and hardware subjects. You also get a complete up-to-date collection of all published "Gateway", the ARRL Packet Radio newsletter. As big as the ARRL HANDBOOK. ©1985 over 1000 pages.

□AR-CNC Softbound \$17.95

5th COMPUTER NETWORKING CONFERENCE PAPERS ©1986

□AR-CNC5 Softbound \$9.95

6th ARRL COMPUTER NETWORKING CONFERENCE ©1987

August 1987

□AR-CNC6 Softbound \$9.95

7th ARRL COMPUTER NETWORKING CONFERENCE ©1988

□AR-CNC7 Softbound \$11.95

INTRODUCTION TO PACKET RADIO

by Phil Anderson, WØXI

This book contains a broad overview of packet radio for the beginner. Simple technical discussions are designed to inform, not scare the beginner. ©1988. 58 pages. 1st Edition.

□KT-IPR Softbound \$2.95

PACKET COMMAND

by Buck Rogers, K4ABT

This book is a basic look at packet radio from the inside out. Similar commands are grouped together with simple easy-to-understand explanations. ©1988 58 pages, 1st Edition.

□KT-PC Softbound \$2.95

ADVANCED PACKET

by Buck Rogers, K4ABT

This book looks at the more advanced side of packet operation. Includes 2400 baud data transfer, FAX and WEFAX, packet cluster information and more. ©1988, 58 pages, 1st Edition.

□KT-AP Softbound \$2.95

DIGITAL COMMUNICATIONS WITH AMATEUR RADIO

special AEA edition by Jim Grubbs, K9EI

Starts with a basic review of digital communications and techniques and includes a complete description of what packet radio is all about. TNCs, operating modes, networking are all fully covered in easy-to-understand terminology. Also covered are accessories, innovations and interesting organizations you can join. ©1988, 1st Edition, 160 pages.

□AEA-PKT Softbound \$9.95

Please enclose \$3.75 shipping and handling.

HAM RADIO'S BOOKSTORE

Greenville, NH
03048

(603) 878-1441

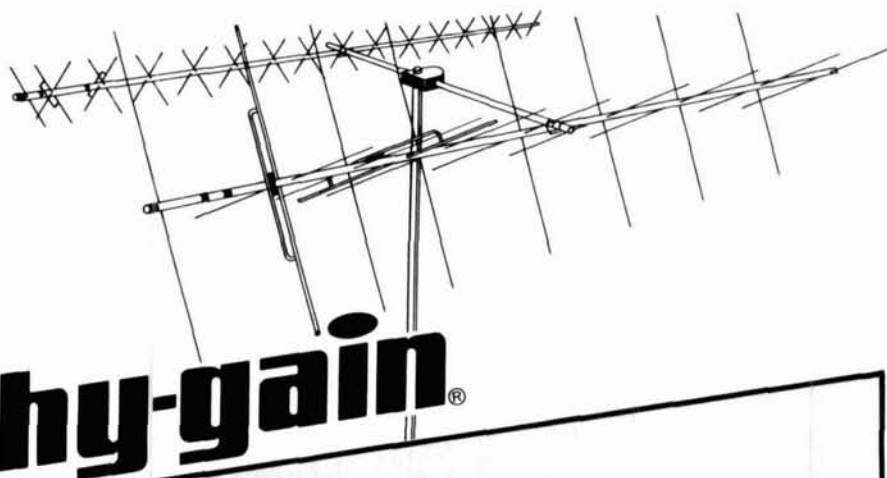

hy-gain®

Link up with OSCAR

The new OSCAR system is modular so you can pick and choose the antenna you want. Each comes complete with the necessary phasing lines, relays and hardware:

435 ANTENNA • 145.9 ANTENNA

Of course, your best choice is the complete system, matched and balanced for superior performance.

- The flexible design with switchable up/down link antennas is suitable for worldwide application. Includes left and right circularity switching to reduce fading (less than 3 dB ellipticity).
- High efficiency "T" matched driven element.
- True RF switching relays are rated at 200 watts and improve the VSWR for higher efficiency.
- Weather-protected, encapsulated feed points for long life. The 2 meter antenna has a S0-239 connector. The 70 cm antenna has a Type N connector.
- The heavy-walled fiberglass cross boom maintains the integrity of the circularity pattern and eliminates the interaction problems so common with metal booms.
- MIL-spec coax balun with Teflon dielectric and outer covering. A silver plated braid shield and center conductor assure minimum attenuation and long life.
- The 70 cm antenna is based on 4.2 wave length NBS design (NBS Tech Note 688).
- The 2 meter antenna has logarithmic element spacing for high attenuation of side lobes.
- For years of maintenance-free operation, the elements come with stainless steel positive locking rings and UV stabilized insulators.
- The mechanically well balanced antennas require only a small turning radius and exert minimal stress on the elevation rotator.

Hy-Gain, with the quality you've come to rely on, is now ready to "LINK UP WITH OSCAR". Complete data available at your amateur radio dealer or write Amateur Radio Department, Telex/Hy-Gain, 9600 Aldrich Avenue South, Minneapolis, MN 55420.

Or call us toll-free at

1-800-328-3771

(In Minnesota call 612-887-5528)

TELEX hy-gain

TELEX COMMUNICATIONS, INC.

BATTERIES "R" US...

You've bought our replacement batteries before...
NOW YOU CAN BUY DIRECT FROM US, THE MANUFACTURER!



ICOM
 CM2, PB2 7.2v @ 500MAH
 CM5, PB5 10.8v @ 500MAH
 SUPER 7S & 8S
 13.2v @ 1100MAH
 9.6v @ 1200MAH
 (base charge only - 1" longer)
 Introductory Offer!
 SUPER 7S & 8S - \$64.95 each

AUGUST SPECIAL!

Kenwood PB-1 and
 KNB-4 Replacement
 Batteries. An
 additional 10% OFF
 orders received in the
 month of August.

Look for next month's
SEPTEMBER Special!



YAESU/MAXON
 * FNB-10 7.2v @ 600MAH
 * FNB-12 12v @ 500MAH
 * FNB-10(S) 7.2v @ 1000MAH
 * same size case as FNB-12
 Introductory Offer!
 P4W 11v @ 500MAH - \$22.63
 FNB-2 11v @ 500MAH - \$22.63



**CUSTOM MADE BATTERY
 PACKS & INSERTS**
 Made to your specifications.
 Introductory Offer!
KENWOOD INSERTS
 PB-21 - \$13.75, PB-25 - \$20.00,
 PB-26 - \$20.00
ICOM INSERTS
 BP-5 - \$23.00, BP-3 - \$18.95,
 BP-7, BP-8

Prices subject to change without notice.



MasterCard and Visa
 cards accepted. NYS
 residents add 8 1/4%
 sales tax. Add \$3.50
 for postage and
 handling.



**SOURCE FOR ALL YOUR COMMUNICATION
 BATTERY REPLACEMENT NEEDS.**

W & W ASSOCIATES

29-11 Parsons Boulevard, Flushing, N.Y. 11354

WORLD WIDE DISTRIBUTORSHIPS AVAILABLE. PLEASE INQUIRE.

**MADE IN
 THE USA**

Send for free
 catalog &
 price list!

In U.S. & Canada Call Toll Free (800) 221-0732 • IN NYS (718) 961-2103 • Telex: 51060 16795 • FAX: (718) 461-1978

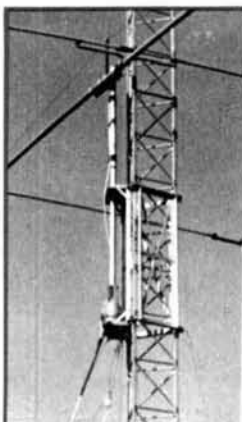

**SAVE
 TIME
 and
 MONEY
 with
 THE
 HAZER**

**Bring things down for
 safety and convenience.**

Never climb your tower again with this elevator system. Antennas and rotator mount on HAZER, complete system trams tower in vertical upright position. Safety lock system operates while raising or lowering. Never can fall.

Complete kit includes winch, 100 ft. of cable, hardware and instructions. For Rohm 20 and 25 G Towers.

Hazer 2-Heavy duty alum. 12 sq. ft. load \$311.95 ppd.
 Hazer 3-Standard alum. 8 sq. ft. load \$223.95 ppd.
 Hazer 4-Heavy galv. steel 16 sq. ft. load \$291.95 ppd.

NEW for ROHN 45 and 55 Towers

Hazer 8-Heavy duty galv. steel 16 sq. ft. load CALL
 Ball Thrust Bearing TB-25 for any of above \$69.50 ppd.

Send for free details of aluminum towers specifically engineered for use with the Hazer. Two sizes; M-13 (13" wide) and M-18 (18" wide). All bolted construction, no welds. Easy to install hinge base, walk up erection. Complete tower UPS or air freight shippable. Pre-assembled or kit form.

Satisfaction guaranteed. Call today and charge to Visa, MasterCard or mail check or money order.

GLEN MARTIN ENGINEERING INC.

Rte 3, Box 322
 Boonville, MO 65233

(816) 882-2734 FAX 816-882-7200



5-1000 MHz PREAMPLIFIERS

	NF	G	P(1 dB)	\$
WLA20M*	2dB	15dB	0dBm	73
WLA21M	3	13	8	57
WLA22M	4	11	12	61
WLA23M	4	22	12	87
WLA24M	3	23	18	109
WLA25M	5	11	20	82
WLA26M	6	21	24	199

Add \$4 for S&H; *BW 1-500 MHz



WILAM TECHNOLOGY, Div. of

WI-COMM ELECTRONICS INC.

P.O. Box 5174, MASSENA, N.Y. 13662
 (315) 769-8334

BLACK DACRON® POLYESTER ANTENNA ROPE

- UV-PROTECTED
- HIGH ABRASION RESISTANCE
- REQUIRES NO EXPENSIVE POTTING HEADS
- EASY TO TIE & UNTIE KNOTS
- EASY TO CUT WITH OUR HOT KNIFE
- SIZES: 3/32" 3/16" 5/16"
- SATISFIED CUSTOMERS DECLARE EXCELLENCE THROUGHOUT U.S.A.

LET US INTRODUCE OUR DACRON® ROPE TO YOU • SEND YOUR NAME AND ADDRESS AND WE'LL SEND YOU FREE SAMPLES OF EACH SIZE AND COMPLETE ORDERING INFORMATION.

Dealer Inquiries Invited



synthetic
 textiles, inc. 2472 EASTMAN AVE., BUILDING 21
 VENTURA, CALIFORNIA 93003
 (805) 658-7903

DAKRON® IS A REGISTERED TRADEMARK

be many makes, it seemed to Wyn that there were only two manufacturers of the devices, regardless of the name tag — General Electric and Frigidaire. Extensive monitoring showed the General Electric manufactured ranges to be relatively free of RFI, but the Frigidaire ranges completely wiped out the short-wave spectrum during operation!

The RFI battle is an uphill fight and it gets very discouraging. My radar range wiped out all HF reception, jammed the TV receiver, and made the kitchen radio unusable. A call to the manufacturer brought the news that I could buy a line filter for the range at a modest price. I asked the sales representative why they didn't install the filter on the oven before it was sold. He told me that it was installed on all export models, because most overseas countries demanded it. However, since there was no comparable law in the United States, they didn't feel it was their duty to protect the local customer in this regard! Alas. Perhaps it's time for the FCC to take a more active role in RFI regulation, a role they have been noticeably successful in avoiding to date.

The "Dead Band" quiz

I want to thank those of you who took the time to write me about these little brain teasers. I really appreciate your letters and comments. I want to acknowledge the following who provided correct answers to past quizzes.

Submitting correct answers in the "black box five-terminal network" quiz are: Albert Weller, Jr., WD8KBW; Martin Woll, N6VI; Tim Bratton, K5RA; Les Hannibal; Lawrence Roy, KA1ADF; Arthur Erdman, W8VNX; Mike Czuhajewski, WA8MCQ; Harold Muensterman, N9DEO; and Clayton Dunnihoo, K5ESV.

There are several configurations that satisfy the problem, the simplest being

five 0.5-ohm resistors arranged in a five-pointed star with a common center.

Those who found the solution to the "resistors in a jar" quiz were: Martin Woll, N6VI; Tim Bratton, K5RA; Harold Muensterman, N9DEO; and Clayton Dunnihoo, K5ESV. (The minimum resistor count is 419.)

A new "Dead Band" quiz

If we have many more of the complete HF blackouts experienced last spring, you should have plenty of time to solve this puzzle, submitted by Andy Loomis, KE0UL.

"A snowplow begins to clear a roadway at noon on a day during a steady snowfall. The plow moves two miles during the first hour and one mile during the second. What time did the snow begin to fall?"

Andy says, "This is not a trick question, nor is it a problem with a quick but not obvious solution. The fascination of the problem lies in the apparent lack of enough information given in the question itself."

Good luck! I'll send the reader who produces the first complete, correct answer to this quiz an autographed copy of the *Beam Antenna Handbook*. Send your answers to me at Box 7508, Menlo Park, California 94025. The decision of the judges is final. **HP**

Note: The computer-produced curves shown in this article are in close agreement with earlier curves run with an RF bridge by John True, W4OQ, as shown in "How to Design Shunt-fed Systems for Grounded Vertical Radiators," *Ham Radio*, May 1975, page 34.

REFERENCES

1. Harold F. Tolles, W7ITB, "How to Design Gamma Matching Networks," *Ham Radio*, May 1973, page 46
2. Richard A. Nelson, WB0IKN, "Basic Gamma Matching," *Ham Radio*, January 1985, page 29
3. Fred Sontag, N0CAO, "Gamma Matching Programs for the C-64/128," *Ham Radio*, May 1987, page 87
4. William Orr, W6SAI and Stuart Cowan, W2LX, *Beam Antenna Handbook*, Radio Publications, Inc. (Available from the HAM RADIO Bookstore for \$11.95 plus \$3.75 shipping and handling.)
5. Henry Jasik, "Cylindrical Dipoles," *Antenna Engineering Handbook*, First Edition, 1961, McGraw-Hill Book Company, New York.
6. James L. Lawson, W2PV, *Yagi Antenna Design*, Chapter 7, American Radio Relay League, Newington, Connecticut.
7. Katashi Nose, KH6JJ, "Notes on Parasitic Beams," *QST*, March 1960, page 43.

DELTA LOOP ANTENNAS

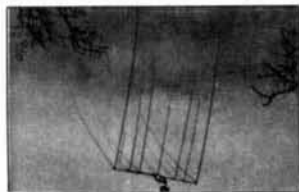

DL-TRI "Big Horn"

- "Open and Close the Band" with our Delta design, full wave DX performance mono-band, duoband and triband antennas
- High Quality construction using 6061-T6 Aluminum and Stainless Steel hardware
- Heavy duty design • "Quiet" DX reception
- Excellent Gain, FB Ratio and SWR
- 50 ohm gamma feed • 2 kw power
- DL 202: 2 el. 20 meter, 9' boom \$397.
- DL 152: 2 el. 15 meter, 6' boom \$329.
- DL 103: 3 el. 10 meter, 9' boom \$397.
- DL 102: 2 el. 10 meter, 5' boom \$297.
- DL 1015: 4 el. duobander \$489.
- 2 el. 10m.-2 el. 15m. 7' boom
- DL-TRI: 7 el. tribander \$897.
- 3 el. 10m.-2 el. 15m.-2 el. 20m. 13.5' boom-wt. 81#-12.7 sq. ft.
- See our Product Review in June 1988 CQ Magazine by Lew McCoy, W1ICP

DELTA LOOP ANTENNAS, INC.
12 BRUSH DR., P.O. BOX 8063
NEW FAIRFIELD, CT 06812
(203) 746-6368

Factory-less, jumper-less, ROM-less programming.



With the new S-COM 5K Repeater Controller, you'll be able to configure your repeater remotely — using DTMF commands. Only the 5K offers this capability for just \$195, wired and tested.



S-COM Industries
P.O. Box 1718
Loveland, CO 80539
(303) 663-6000

150

  	<h1>ICOM</h1>
	<p>9:00 am - 5:30 pm weekdays Weekends and evenings by appointment.</p> <p>ICOM, AEA, LARSEN, VAN GORDEN, VIBROPLEX, NYE-VIKING, FALCON COMM, LEADING EDGE, ARRL PUBLI- CATIONS, KAGLO, HAMTRONICS, ETC.</p> <p><i>Western New York's finest... amateur radio dealer!</i></p> <p>PH. (716) 664-6345</p>
<p>280 Tiffany Avenue Jamestown, New York 14701</p>	

Ham Notebook

Automatic Packet Beacon Tracker and Monitor

How often have you set your rig up on 20 or 10 meters to wait for the station you have traffic for, only to find the band isn't open to that area? You sit through countless hours of frustrating QRM, monitoring stations you're not interested in. PACTRACK.ASP, a script file I wrote for the Procomm Plus[®] terminal program (MS-DOS environment),* can help you overcome this trouble.

Written initially to monitor propagation conditions on the 10-meter band, PACTRACK.ASP will turn Procomm Plus into a powerful packet terminal program for the Kantronics KAM TNC[™]. It is easily modified for any of the other popular packet terminal units. To modify the script file for earlier versions of Procomm, change the carriage return character (^M) to an exclamation point (!). The program is written in the ASPECT script language, supported by Procomm.

Program features

Once you've loaded Procomm Plus, activate PACTRACK.ASP by entering ALT F5. The program will ask you for the name of the script file. (The .ASP extension isn't required.) A title screen appears, listing the stations the program has been modified to monitor. You'll be asked to turn on your printer. Disable this feature if you don't want to print the beacon stations heard. PACTRACK will now perform the following functions for you:

- Monitor for beacon or ID packets from the stations you have included in the program.
- Print out the time and date of reception when a station has been received, and give an indication that your UNPROTO CQ path has been changed to transmit through the station. (See Figure 1.)
- Turn on the beacon at the interval you have selected, if you have



FIGURE 1

```
VDA
DAYTIME 01/28/89 13:51:37
cmd:WJ5V:VE260F/R VE260F-2/G VE260F-1/B VE260F-7/M
nd:*****UNPROTO IS NOW CQ V VE260F-7*****TURN BEACON ON

VE260F<<<< TARGET STATION FOR BEACON *****

*****CAUTION...BEACON IS NOW ON*****

VDA
DAYTIME 01/28/89 14:00:28
cmd:WB4HFQ:ID:WB4HFQ WB4HFQ-2/G WB4HFQ-1/B WB4HFQ-7/M
nd:*****UNPROTO IS NOW CQ V WB4HFQ-7*****TURN BEACON ON

WB4HFQ...07H KY<<<< TARGET STATION FOR BEACON *****

*****CAUTION...BEACON IS NOW ON*****

VDA
DAYTIME 01/28/89 14:10:15
cmd:COUNTY, LI, NY
*****THE BEACON RECEIVED IS NOT LISTED*****
```

Examples of printout using PACTRACK.ASP.

FIGURE 2

```
Alt-0 ID^M
Alt-1 $A^M
Alt-2 XA^M
Alt-3 ^C
Alt-4 CONV^M
Alt-5 D^MD^M
Alt-6 CMS ON^M
Alt-7 CMS OFF^M
Alt-8 GATE ON^M DIGI ON^M HID ON^M
Alt-9 GATE OFF^M DIGI OFF^M HID OFF^M
```

Procomm Plus keyboard macro screen with settings for packet radio.

- included the beacon option in the program.
- Print out the time, date, and call of the station with a notice that the station received was not listed, if you receive a beacon or ID packet from a station other than those included in the program.
- Allow modification of the program to send a connect request to a specific

station once it has been received, rather than automatically change your UNPROTO path.

Other Procomm features

Included in the Procomm Plus program is a keyboard macro screen which lets you set up the ALT 0-9 keys for your particular application. My keys are set up as shown in Figure 2. My keyboard macro, called KAM.KEY, is loaded automatically when the PACTRACK script file is called up.

Procomm also includes a "chat" mode. This is a split screen mode; the top three-quarters of the screen displays the received text, and the bottom quarter displays your transmitted text as entered from the keyboard. Entering ALT O activates the split screen option. I usually do this when I am communicating. You must activate full-duplex mode to use the split screen. You can accomplish this easily by entering ALT E; PACTRACK.ASP is loaded initially in the half-duplex mode and must be in half duplex to operate correctly. When you're finished with split screen mode, simply enter ESC to return to terminal mode and enter ALT E to return to half-duplex mode.

I'm looking forward to hearing from you experienced programmers regarding enhancements to PACTRACK. I'm not a programmer and this was my first attempt. However, the program runs very well and does what it was designed to do. For those who would prefer to send comments via packet radio, send them to W4GBB at WA4ONG in Richmond, Virginia.

If you don't want to type in the program, I'll send you the PACTRACK.ASP program and the keyboard macro file for \$10. The Procomm Plus package is available from most local BBSs.* If you want to have the PACTRACK.ASP program customized for your particular application, include the following information:

- Call, QTH of the station(s) to be monitored

*Procomm Plus is a registered trademark of Datastorm Technologies, Inc., P.O. Box 1471 Columbia, Missouri 65205.

*Procomm is a user-supported product. It is not public domain, and is not free software. To become a registered user, send \$25 for registration only, \$35 for registration plus the latest version on disk, or \$50 for registration plus the latest version and a printed, bound manual to the address listed. Procomm support BBS: (314)449-9401 24 hours a day, seven days a week.

FREE CATALOG!

Features Hard-to-Find Tools
and Test Equipment



Jensen's new catalog features hard-to-find precision tools, tool kits, tool cases and test equipment used by ham radio operators, hobbyists, scientists, engineers, laboratories and government agencies. Call or write for your free copy today.

JENSEN®
TOOLS INC.

Dept. HR
7815 S. 46th Street
Phoenix, AZ 85044
(602) 968-6231

✓ 157

SYNTHESIZED SIGNAL GENERATOR



MODEL
SG-100F
\$429.95
delivered

MADE IN
USA

- Covers 100 MHz to 199.999 MHz in 1 kHz steps with thumbwheel dial
- Accuracy ± 1 part per 10 million at all frequencies
- Internal FM adjustable from 0 to 100 kHz at a 1 kHz rate
- External FM input accepts tones or voice
- Spurs and noise at least 60 dB below carrier
- Output adjustable from 5-500 mV at 50 Ohms
- Operates on 12 Vdc @ $\frac{1}{2}$ Amp
- Available for immediate delivery • \$429.95 delivered
- Add-on accessories available to extend freq range, add infinite resolution, AM, and a precision 120 dB attenuator
- Call or write for details • Phone in your order for fast COD shipment.

VANGUARD LABS

196-23 Jamaica Ave., Hollis, NY 11423
Phone: (718) 468-2720 Mon. thru Thu.

✓ 158

Want to sell
Ham Radio
in your store?

Call Sue:
603-878-1441

High Performance vhf/uhf preamps

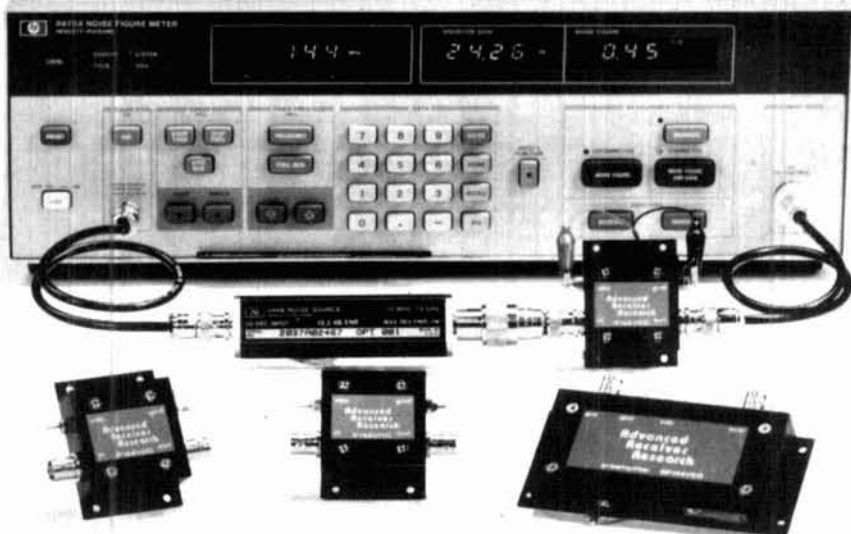

Receive Only	Freq. Range (MHz)	N.F. (dB)	Gain (dB)	1 dB Comp. (dBm)	Device Type	Price
P28VD	28-30	< 1.1	15	0	DGFET	\$29.95
P50VD	50-54	< 1.3	15	0	DGFET	\$29.95
P50VDG	50-54	< 0.5	24	+12	GaAsFET	\$79.95
P144VD	144-148	< 1.5	15	0	DGFET	\$29.95
P144VDA	144-148	< 1.0	15	0	DGFET	\$29.95
P144VDG	144-148	< 0.5	24	+12	GaAsFET	\$79.95
P220VD	220-225	< 1.8	15	0	DGFET	\$29.95
P220VDG	220-225	< 1.2	15	0	DGFET	\$37.95
P220VDG	220-225	< 0.5	20	+12	GaAsFET	\$79.95
P432VD	420-450	< 1.8	15	-20	Bipolar	\$32.95
P432VDA	420-450	< 1.1	17	-20	Bipolar	\$49.95
P432VDG	420-450	< 0.5	16	+12	GaAsFET	\$79.95

Inline (rf switched)

SP28VD	28-30	< 1.2	15	0	DGFET	\$59.95
SP50VD	50-54	< 1.4	15	0	DGFET	\$59.95
SP50VDG	50-54	< 0.55	24	+12	GaAsFET	\$109.95
SP144VD	144-148	< 1.6	15	0	DGFET	\$59.95
SP144VDA	144-148	< 1.1	15	0	DGFET	\$67.95
SP144VDG	144-148	< 0.55	24	+12	GaAsFET	\$109.95
SP220VD	220-225	< 1.9	15	0	DGFET	\$59.95
SP220VDA	220-225	< 1.3	15	0	DGFET	\$67.95
SP220VDG	220-225	< 0.55	20	+12	GaAsFET	\$109.95
SP432VD	420-450	< 1.9	15	-20	Bipolar	\$62.95
SP432VDA	420-450	< 1.2	17	-20	Bipolar	\$79.95
SP432VDG	420-450	< 0.55	16	+12	GaAsFET	\$109.95

Every preamplifier is precision aligned on ARR's Hewlett Packard HP8970A/HP346A state-of-the-art noise figure meter. RX only preamplifiers are for receive applications only. Inline preamplifiers are rf switched (for use with transceivers) and handle 25 watts transmitter power. Mount inline preamplifiers between transceiver and power amplifier for high power applications. Other amateur, commercial and special preamplifiers available in the 1-1000 MHz range. Please include \$2 shipping in U.S. and Canada. Connecticut residents add 7-1/2% sales tax. C.O.D. orders add \$2. Air mail to foreign countries add 10%. Order your ARR Rx only or inline preamplifier today and start hearing like never before!

Advanced Receiver Research

Box 1242 • Burlington, CT 06013 • 203 582-9409



✓ 156

2 METER AMPLIFIERS • ATV CONVERTERS

DISCOVER THE WORLD OF FAST SCAN TELEVISION:



AMATEUR TELEVISION CONVERTERS
ATV-2 430-450 MHz \$ 44.95 Kit
ATV-3 420-450 MHz GaAs-Fet \$ 49.95 Kit
ATV-4 902-928 MHz GaAs-Fet \$ 59.95 Kit

Available in Kit or Assembled/Tested
Add \$ 2.00 For Shipping and Handling

RF Amplifiers Per Motorola Bulletins

Complete Parts list for
140 Watt or 300 Watt HF Amplifiers per
Motorola Bulletins
AN-758, AN-762, EB-27A, EB-63

CAMBION RF CHOKES
0.15 uh, 0.22 uh, 0.33 uh \$ 1.70
4.7 uh, 10.0 uh

MIXERS
SBL-1 DBL Bal Mixer \$ 6.50
SBL-1X DBL Bal Mixer \$ 7.95

FERROX-CUBE DEVICE
VK200-20/4B RF Choke \$ 1.20
56-590-65-3B Ferrite Bead \$ 2.00

POWER SPLITTER/COMBINER
2-30 MHz, 600 Watts (2 Port or 4 Port)



BROADBAND TRANSFORMERS
PER MOTOROLA BULLETINS

We Also Stock Hard-To-Find Parts
KEMET CHIP CAPACITORS
METALCLAD MICA CAPACITORS
SEMICONDUCTORS
RF POWER TRANSISTORS

For detailed information, please
call or write for our free catalog



CCI Communication
Concepts Inc.

121 Brown Street • Dayton, Ohio 45402 • (513) 220-9677



✓ 159

- Printer or no printer
- Want beacon automatically turned on?
- Hard drive or floppy?
- Special beacon text
- Monitor for beacons or IDs?
- Information you want in your keyboard macro file

If you send me this information, I'll customize your program for the Kantronics KAM TNC. 

Robert F. Cann, W4GBB

Editor's note: Send a no. 10 SASE to *Ham Radio* for a hard copy of the PACKTRACK ASP program and macro file.

Mobile HT Audio — The Near Ultimate Solution

Many articles have been written describing schemes for improving the audio output from handheld transceivers, especially when operating mobile. The low output power leaves a lot to be desired when combined with vehicle and road noise. The usual fix involves building an external amplifier.

I've often wondered why I try listening to a 2-inch speaker driven by a few

milliwatts of power while my car stereo system sits idle. Here's an easy, no modification required way, of using your car's audio system with your HT, for those of you with a built-in cassette player. I designed a cassette adapter that looks like a standard cassette tape with a cable that plugs into the HT's external speaker jack. You insert the adapter into the tape player as you would any standard cassette. I found out later from my son that my "creation" was already commercially available!

The device, marketed by Radio Shack as a "Compact Disc Cassette Adapter," is sold under catalog number 12-1951 for \$19.95. It lets you play portable CD units through your cassette tape player. It comes equipped with a miniature stereo plug, the same size as the external speaker jack on my HT. When used in this manner, the HT will "play" through one channel of the stereo system.

There are three simple ways of converting the adapter to a mono system so you can use both stereo channels:

- Use a mono-to-stereo adapter plug, like Radio Shack no. 274-368. This is the preferred method, since the

unmodified unit will be available for use with a stereo source like a CD player. However, the size of the adapter plug may interfere with the external microphone plug on some HTs.

- Replace the stereo plug with a mono plug, paralleling both inputs. This is the most difficult modification to make, because you need to connect both inputs to a single mini-plug.
- Add a short jumper wire at the cable terminations on the pc board inside the cassette. (The board contains an RC network.) This involves removing six screws (two on the top and four on the bottom of the cassette), adding a jumper between the red and white cable leads, and reassembling the cassette.

Now you can enjoy HT mobiling with the audio available from your car stereo system, without modifying the HT or the car stereo. Use the tone controls to reduce hiss and enhance weak signals. You'll be amazed at how good an HT can sound.

Frank H. Finney, W9PXP

antennex

"The Magazine About Antennas"
IF YOU -

- Have a lousy mobile signal on all bands?
- Need an inexpensive beam for 10 meters?
- Unsure about using vert vs horiz antenna?
- Need a low noise antenna for 160 meters?
- Want to design an antenna just for you?
- Need a program for design and plotting?
- Need to solve a unique problem?
- Know the best antenna for hamsats, etc.?
- Need a disguised mobile antenna?
- Want a cheap automatic coupler system?
- Just want to learn more about antennas?

THEN SUBSCRIBE TO - **antennex**
12 MONTHLY ISSUES is only \$15.97 for
USA and possessions. \$19.97 foreign.

antennex

P.O. Box 8995 Dept. 19
Corpus Christi, TX 78412

160

THE K1FO 16 ELEMENT 220 MHz YAGI

Model FO-16-220



\$114.95

ELECTRICAL SPECIFICATIONS:

Measured gain	14 dBd
E-Plane beamwidth	26 deg
H-Plane beamwidth	33 deg
Sidelobe attenuation	
1st E-Plane	-18 dB
1st H-Plane	-16.5 dB
SWR	1:12 typical
F/B ratio	22.5 dB
Impedance	50 ohm

MECHANICAL SPECIFICATIONS:

Length	178.4 in
Boom	1.375" 6061 T-6 Aluminum
Elements	3/16" Aluminum rod
Wind survival	120 MPH
Mast	up to 2" diameter
Element Insulators	Black Delrin
Stainless Steel hardware	(except U-bolts)
Coax connector	N-type

ALSO AVAILABLE

FO-12-144, FO-22-432, FO-25-432, FO-33-432, FO-11-440

POWER DIVIDERS STACKING FRAMES

We supply those hard to find parts for the home builder:
3/16" Delrin insulators \$12/100. Stainless keepers \$10/100
Add \$5 UPS SH for each antenna
\$7 west of Mississippi
PA residents add 6% state sales tax.

RUTLAND ARRAYS

1703 Warren Street • New Cumberland, PA 17070
(717) 774-5298 7-10 P.M. EST

Dealer inquiries are invited

161



R-7000 Widespan Panadaptor

Panadaptor especially designed for the R-7000 receiver. For use with a standard scope. Variable span width from 1 to 10 Mhz. Uncover unknown elusive signals. Complete with all cables, & 90 day warranty. \$349.95 Shipped. Pa. res. add 6%.

GTI Electronics

RD 1 BOX 272
Lehighton, Pa. 18235
717-386-4032

162



CALL US NOW!

In 1937, Stan Burghardt (WØIT), because of his intense interest in amateur radio, began selling and servicing amateur radio equipment in conjunction with his radio parts business. We stand proud of this long-lasting tradition of *Honest Dealing, Quality Products and Dependable "S-E-R-V-I-C-E"!*

Above all, we fully intend to carry on this proud tradition with even more new product lines plus the same "fair" treatment you've come to rely on. Our reconditioned equipment is of the finest quality with **30, 60** and even **90-day** parts and labor warranties on selected pieces. *And always remember:*

— WE SERVICE WHAT WE SELL —

AEA	B & W	Daiwa	Palomar
Alinco	Belden	Hustler	Radio Callbook
Ameritron	Bencher	Kantronics	Ritron
Amphenol	Bird	Kenwood	Rohn
Ampire	Butternut	Larsen	Telex/Hygain
Antenna Specialists	Centurion	MFJ	Ten-Tec
Astron	CES	Mirage/KLM	Unadilla/Reyco
	Cushcraft	Mosley	Yaesu

Write today for our latest Bulletin/Used Equipment List.

YOUR HAM DOLLAR GOES FURTHER AT...

CALL OR WRITE FOR SPECIAL QUOTE

When it comes to **FAST DELIVERY, HONEST DEALING** and **PROMPT/DEPENDABLE S-E-R-V-I-C-E** back-up. We don't just advertise it — **WE GIVE IT!**

we'll treat you

SELECTION
S-E-R-V-I-C-E
and
SATISFACTION!

STORE HOURS:
9-5 P.M. (CST)
MONDAY thru FRIDAY
OPEN SATURDAYS
from 9-1 P.M. (CST)
CLOSED
SUNDAYS/HOLIDAYS



182 N. Maple
P.O. Box 73
Watertown, SD 57201

Burghardt INC.
AMATEUR CENTER

"AMERICA'S MOST RELIABLE AMATEUR RADIO DEALER"

SELL-TRADE

New & Reconditioned HAM EQUIPMENT

Call or Write Us Today For a Quote!
You'll Find Us to be Courteous, Knowledgeable and Honest

PHONE (605) 886-7314

FAX (605) 886-3444



Get the most of HF Mobiling

Yaesu FT-747GX

SPECIAL OFFER!

CALL TODAY FOR SPECIAL QUOTE

NEW SUPER LONG PLAY TAPE RECORDERS
12 Hour Model — \$119.00*
USES D-120 TAPE

Modified Panasonic Slimline, high quality, AC-DC Recorders provide 6 continuous hours of quality recording & playback on each side of cassette for a total of 12 hours. Built-in features include • Voice level control • Digital counter, etc. TDK DC 120 Cassette Furnished.



PHONE RECORDING ADAPTER
Records calls automatically. All Solid state connects to your telephone jack and tape recorder. Starts recording when phone is lifted. Stops when you hang up.



VOX VOICE ACTIVATED CONTROL SWITCH
Solid state. Self contained. Adjustable sensitivity. Voices or other sounds automatically activate and control recorder. Uses either recorder or remote mike. \$28.50*
FCC APPROVED



*Add for ship & hdlg. Phone Adapter & Vox \$1.50 ea. Recorders \$4.00 ea. Cal. Res. add tax. Mail order, VISA, M/C, COD's OK. Money Back Guarantee. Qty. disc. avail., Dealer inquiries invited, Free data.
AMC SALES INC. Dept. H, 9335 Lubec St., Box 928, Downey, CA 90241 Phone (213) 869-8519



FALCON COMMUNICATIONS

The VHF MOSFET power amplifier pioneer, has some new products; Antennas for special needs.

HERE NOW

The "Armchair Antenna", improves the range of hand helds, or scanners, using "rubber duckies" or 1/4 wavelength whips.

Adjustable for any frequency from 144 to over 500 MHz, this dipole needs no ground plane, is used horizontally or vertically and, at 1/2 wavelength, is more efficient than short antennas. A balun reduces pattern distortion for "boresight" aiming.

COMING SOON

For the RVer, a tilt-up telescoping HF vertical that adjusts to any frequency from 3 to 30 MHz.

The fiberglass mast extends to full height for all frequencies. The antenna length is varied inside the mast with a 12 Volt motor, also inside the mast, and can be controlled from inside the RV.

Two versions are coming; one for small RVs and vans and the second for large RVs.

For Information On Our Complete Line See Your Local Dealer Or Call Factory Direct
P.O. Box 8979 • Newport Beach, CA 92658 • (714) 760-3622

The no-hole, On-Glass[®], mobile antenna that installs in 15-minutes.

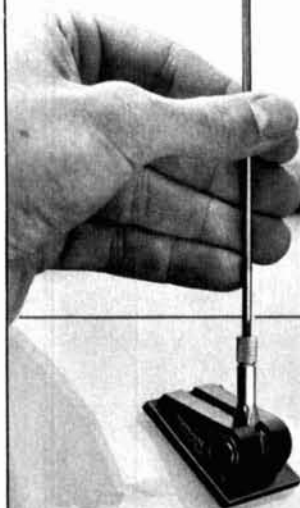

- **Capacitive coupling** establishes highly tuned circuit through glass with no measurable signal loss.
- **No ground plane:** Full halfwave design — performance equal to practical 5/8 wave installations.
- **DUO-BOND™ mounting** for firm, fast, waterproof bonding. Removable without damaging car or antenna.
- **No holes:** No vehicle damage; fast, easy cable routing.
- **Models for 2 meter, 220 MHz and UHF amateur bands.**



a member of **The Allen Group Inc.**
30500 Bruce Industrial Parkway
Cleveland, OH 44139-3996
216/349-8400, Telex: 4332133, Fax: 216/349-8407

"helping the world communicate"®

✓ 168

PC Slow Scan \$149.95

A complete slow scan television station for your IBM PC or compatible. Send and receive images in up to 10 shades of gray depending upon your graphics card and printer.

Includes:

Demodulator Modulator 75 Page Manual
Software Tutorial Cassette

Requires:

Ham transceiver PC with 640K Parallel Port
Graphics Card Tape Recorder Serial port
Slow Scan Formats: 8, 12, 17, 23, 34, 36, 48, 72 sec.



Software Systems Consulting
1303 S. Ola Vista
San Clemente, CA 92672
(714) 498-5784

✓ 167

Foreign Subscription Agents for Ham Radio Magazine

Ham Radio France
SM Electronic
20 bis, Ave des Clarions
F-89000 Auxerre
France

Ham Radio Canada
C.A.R.F.
P.O. Box 356
Kingston, ON
Canada K7L 4W2
Prices in Canadian funds
1 yr. \$38.00, 2 yrs. \$67.00
3 yrs. \$90.00

Ham Radio Japan
Katsumi Electronic Co., Ltd.
27-5 Ikegami
4 Chome, Ota-Ku
Tokyo 146, Japan
Telephone (03) 753-2405

Ham Radio England
c/o R.S.G.B.
Lambda House
Granborne Road
Potters Bar
Herts EN6 3JW
England

NEMAL ELECTRONICS

- *Complete Cable Assembly facilities MIL-STD-45208
- *Commercial Accounts welcome- Quantity pricing * Same day shipping most orders
- *Factory authorized distributor for Alpha, Amphenol, Belden, Kings, Times Fiber

Call NEMAL for computer cable, CATV cable, Flat cable, semi-rigid cable, telephone cable, crimping tools, D-sub connectors, heat shrink, cable ties, high voltage connectors.

HARDLINE 50 OHM

FXA12 1/2" Aluminum Black Jacket.....	89/ft
FLC12 1/2" Cablewave corr. copper blk jkt	1.69/ft
FLC78 7/8" Cablewave corr.copper blk jkt	4.25/ft
NM12CC N conn 1/2" corr copper m/1	25.00
NM78CC N conn 7/8" corr copper m/1	54.00

COAXIAL CABLES (per ft)

1100 BELDEN 9913 very low loss55
1102 RG8/U 95% shield low loss foam 11ga.....	.36
1110 RG8X 95% shield (mini 8)17
1130 RG213/U 95% shield mil spec MCV jkt.....	.39
1140 RG214/U dbi silver shld mil spec.....	1.85
1705 RG142B/U dbi silver shld, teflon ins	1.50
1310 RG217/U 50 ohm 5000 watt dbi shld98
1450 RG174/U 50 ohm .100" od mil spec14

ROTOR CABLE-8 CONDUCTOR

8C1822 2-18ga and 6-22ga	25
8C1820 2-16ga and 6-20ga	39

CONNECTORS-MADE IN USA

NE720 Type N plug for Belden 9913	\$3.95
NE723 Type N jack for Belden 9913.....	4.95
PL259AM Amphenol PL25989
PL259TS PL259 teflon ins/silver plated.....	1.59
PL259AM Amphenol female-female (barrel).....	1.65
UG175/UG176 reducer for RG58/59 (specify).....	.22
UG21DS N plug for RG8,213,214 Silver	3.35
UG83B N jack to PL259 adapter, teflon	6.50
UG146A SO239 to N plug adapter, teflon	6.50
UG255 SO239 to BNC plug adapter, Amphenol.....	4.29
SO239AM UHF chassis mt receptacle,Amphenol.....	.89
UG88C BNC plug RG58, 223, 142	1.45

GROUND STRAP-GROUND WIRE (per ft.)

GS38 3/8" tinned copper braid40
GS12 1/2" tinned copper braid50
GS200 1-1/2" heavy tinned copper braid	2.00
HW08 6ga insulated stranded wire39
AW14 14ga stranded Antenna wire CCS14

Prices do not include shipping, \$3 minimum, Visa/Mastercard \$30 min, COD add \$3.00
Call or write for complete price list. NEMAL's new 40 page CABLE AND CONNECTOR SELECTION GUIDE is available at no charge with orders of \$50 or more, or at a cost of \$4 with credit against next qualifying order.

NEMAL ELECTRONICS, INC. 12240 NE 14th Ave. N. Miami, FL 33161
(305) 893-3924 Telex 6975377 24hr FAX (305)895-8178

SHORT CIRCUIT HOTLINE



Practically Speaking

Joseph J. Carr, K4IPV

VERTICALLY POLARIZED HF ANTENNAS: PART 1

Antennas are a favorite topic for technical writers because our mailbags show that they're a very popular subject with readers. This month, and for the next two months, I'll discuss vertical antennas. Although the regard with which Amateurs view verticals varies from "tremendous" down to "little better radiator than a dummy load," the vertical remains popular. My own luck with verticals has been mostly good. The vertical is the antenna of choice for people living in cramped quarters that don't allow a beam antenna.

Will the vertical antenna work as well as a Yagi beam or quad up 100 feet? The answer is a qualified "maybe." The problem is context. For the DXer the beam is the hands-down favorite if money is no object. But in a situation where an omnidirectional horizontal pattern is needed, the beam suffers. So the correct answer to such a question is, "for what application?"

Because there are so many heated opinions regarding verticals, I take on this topic with some trepidation. Let's hope that a little more light than heat is generated. Keep in mind that it's possible your buddy's bad luck with a vertical might be due to not knowing how to design, build, and use one — or expecting something totally inappropriate from the antenna.

The polarity of an antenna is the direction of the electrical (E) field. Because the transmitted signal is an orthogonal electromagnetic wave, the magnetic field radiated from the antenna is at right angles to the electrical field. The direction of the electrical field, which sets the polarity of the antenna, is a function of the geometry of the radiator element. If the element

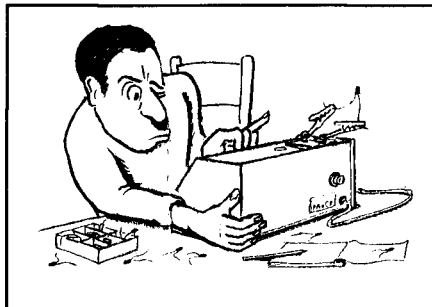
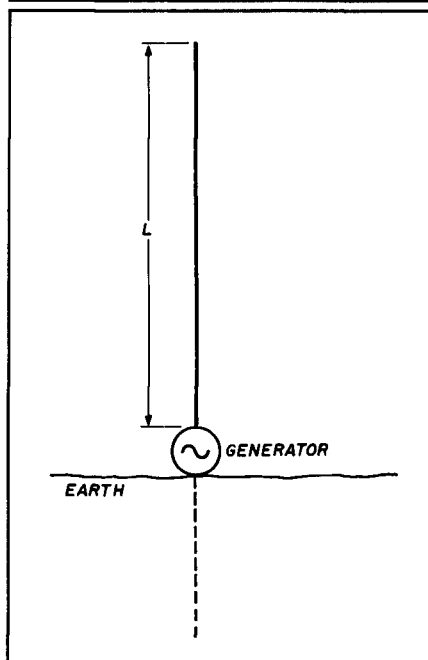

FIGURE 1A



Basic concept of a vertical antenna.

is vertical, then the antenna polarity is also vertical. The signal propagates out from the radiator in all directions of azimuth, making this antenna an "omnidirectional" radiator.

Figure 1A shows the basic geometry of the vertical antenna: an RF generator (transmitter or transmission line) at the base of a radiator of length L . Although most commonly encountered verticals are quarter wavelength ($L = \lambda/4$), that length isn't the only permissible one. In fact, it may not even be the most desirable length. I'll talk about the standard quarter-wavelength vertical antenna here because it's so popular, and will

also deal with other length verticals (both greater and less than quarter wavelength).

The quarter-wavelength vertical antenna can be modeled as half a dipole installed perpendicular to the ground, with the ground as the "other half" of the dipole. Because of this, some texts show the vertical with a dotted line "ghost radiator" in the earth beneath the main antenna element. Figure 1B shows the approximate current and voltage distribution for the quarter-wavelength vertical. Like the dipole, the quarter-wavelength vertical is fed at a current node, so the feedpoint impedance is at a minimum (typically 35 to 55 ohms, depending upon nearby objects). As a result, the current is maximum and the voltage is minimum at the feedpoint. As you'll see, however, not all vertical antennas are fed directly at the current node. As a result, some designs require antenna tuning units to make them match the antenna impedance to the transmitter output impedance.

Figures 2A and 2B show the two basic configurations for the HF vertical antenna. Figure 2A shows the ground-mounted vertical antenna. The radia-

FIGURE 1B

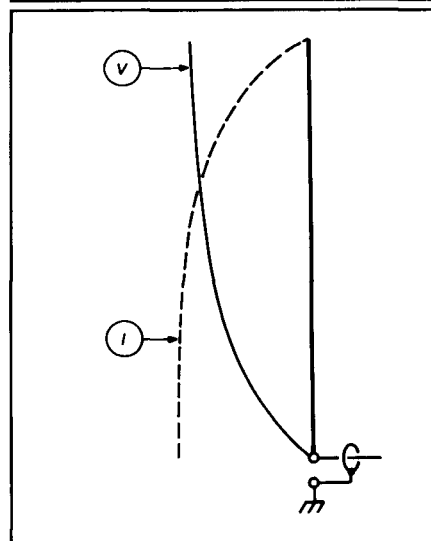

Approximate current and voltage distributions on a quarter-wave vertical.

PRESENTING
**THE K1FO 25 ELEMENT
 432 MHz YAGI**



Model FO-25-432
 \$129.95

ELECTRICAL SPECIFICATIONS:
 Measured gain 16.5 dBd
 E-Plane beamwidth 22 deg
 H-Plane beamwidth 23 deg
 Sidelobe attenuation -17 dB
 1st E-Plane -16 dB
 SWR 1.10:1 typical
 F/B ratio 25 dB
 Impedance 50 ohm

MECHANICAL SPECIFICATIONS:
 Length 17ft
 Boom 1.375" 6061 T-6 Aluminum
 Elements 3/16" Aluminum rod
 Wind survival 120+ MPH
 Mast up to 2" diameter
 Element Insulators Black Delrin
 Stainless Steel hardware (except U-bolts)
 Coax connector N-type

ALSO AVAILABLE
 FO-12-144, FO-16-220, FO-22-432, FO-33-432, FO-11-440
 POWER DIVIDERS STACKING FRAMES

We supply those hard to find parts for the home builder
 3/16" Delrin insulators \$12/100, Stainless keepers \$10/100
 Add \$5 UPS SH for each antenna
 \$7 west of Mississippi
 PA residents add 6% state sales tax.

RUTLAND ARRAYS
 1703 Warren Street • New Cumberland, PA 17070
 (717) 774-5298 7-10 P.M. EST
 Dealer inquiries are invited

✓ 161

**MAKE CIRCUIT BOARDS
 THE NEW, EASY WAY**



WITH TEC-200 FILM

JUST 3 EASY STEPS:

- Copy circuit on TEC-200 film using any plain paper copier
- Iron film on to copper clad board
- Peel off film and etch

SATISFACTION GUARANTEED
 convenient 8½ x 11 size

5-Sheets for \$3.95
10 sheets only \$5.95
 add \$1.25 postage — NY res. add sales tax

The MEADOWLAKE Corp.
 DEPT. P, P.O. Box 497
 Northport, New York 11768

✓ 170

U.S. AMATEUR RADIO MAIL LISTS

Labels, floppy disks, CD-ROM, mag tape.

- Newly licensed hams
- All upgrades
- Updated each week

BUCKMASTER PUBLISHING
 Route 3, Box 56
 Mineral, Virginia 23117
 703/894-5777 visa/mc 800/282-5628

HI-PERFORMANCE DIPOLES



Antennas that work! Custom assembled to your center freq. ea. band advise ht of center and each end - hang as inverted "V" - horizontal, vert. dipole, sloping dipole - commercial quality - stainless hardware - legal power - no-trap, high-efficiency design. Personal check, MO or C.O.D. (53)

MPD-5*	80-40-20-15-10M max performance dipole 87" long	\$105ppd
MPD-2	80-40M max performance dipole, 85" long 582	95-\$66 ppd
HPD-3*	160-80-40M hi performance dipole 113" long	\$78 ppd
SSD-6*	160-80-40-20-15-10M space saver dipole 71" long	\$125 ppd
SSD-5*	80-40-20-15-10M space-saver dipole-specify L. 42" \$105 52" \$108 ppd	
SSD-4*	80-40-20-15M space-saver dipole-specify L. 46" \$93 60" \$ 96 ppd	

*9 bands with wide-matching-range tuner.

SASE for catalogue of 30 dipoles, slopers, and space-saving, unique antennas

W9INN ANTENNAS
 312-394-3414 BOX 393 MT. PROSPECT, IL 60056

✓ 172

NEW OSCAR

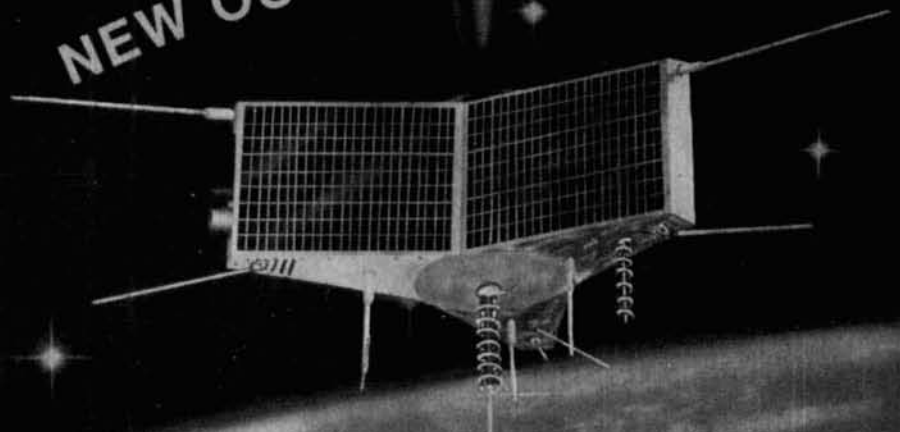

BRIDGES HAMISPHERE

- Coming soon to a shack near you.
- Signals from space.
- Catch some free.
- We know how.
- You can too!
- Join AMSAT
- Free brochure for SASE



AMSAT
 PO BOX 27
 WASHINGTON, DC 20044

✓ 169

HAM RADIO SHIRTS and HATS

Here's a great way to say you're a HAM RADIO reader. Get a hat with your name and call and wear your HAM RADIO Magazine shirt!



Baseball Caps come in gold, blue, red and kelly green. Please give us the name and call sign you want lettered on the hat (maximum of 6 characters per line.)
 UFBC (comes in gold, blue, red, kelly green)\$ 9.95



HAM RADIO shirts come in two attractive styles. The TEE shirt is great for general everyday use. The HAM RADIO polo is for a more formal occasion. Each shirt is made of a 50/50 blend and comes in either blue or red. The new HAM RADIO logo is silk-screened in a vibrant yellow color on the front of each shirt.

Sizes Available:
 S, M, L, XL

HR-TEE B (blue) R (red).....\$ 9.95
 HR-PLO B (blue) R (red).....\$19.95

Please enclose \$3.75 shipping & handling  

HAM RADIO
 GREENVILLE, NH 03048

BOOKSTORE
 (603) 878-1441

FIGURE 2A

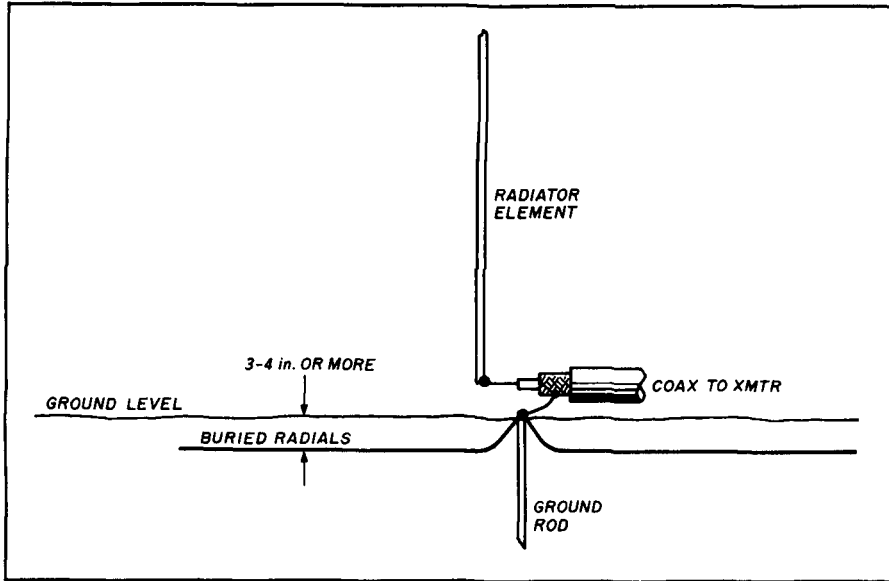

Basic ground-mounted HF vertical.

tor element is mounted at ground level, but is insulated from ground. Because the antenna shown is a quarter wavelength, it's fed at a current node with 52-ohm coaxial cable. The inner conductor of the coaxial cable is connected to the radiator element, while the coaxial cable shield is connected to the ground. As you will see later, the ground system for the vertical antenna is critical to its performance. Normally, the feedpoint impedance isn't exactly 52 ohms, but somewhat lower. As a result, without some matching there will be a slight VSWR. But in most cases the VSWR is a tolerable tradeoff for simplicity. If the antenna has a feedpoint impedance of 37 ohms, the value usually quoted, then the VSWR will be 52 ohms/37 ohms, or 1.41:1.

A vertical mounted above the ground level is shown in Figure 2B. This antenna is as popular as the ground mounted. Amateurs find it easy to construct this form of antenna because the lightweight vertical can be mounted at reasonable heights (15 to 50 feet) using fairly inexpensive television antenna slip-up telescoping masts. A problem with the nonground level vertical antenna is that there's no easy way to connect it to ground. The solution to the problem is to create an artificial counterpoise ground with a system of quarter-wavelength radials.

In general, at least two radials are required for each band — and even that number is marginal. The standard wisdom holds that the greater the

number of radials, the better the performance. While that statement is true,

FIGURE 2B

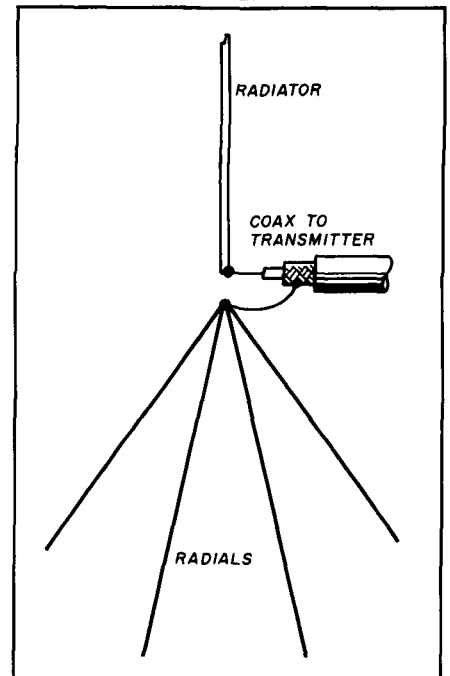

A vertical with elevated radials.

FIGURE 2C

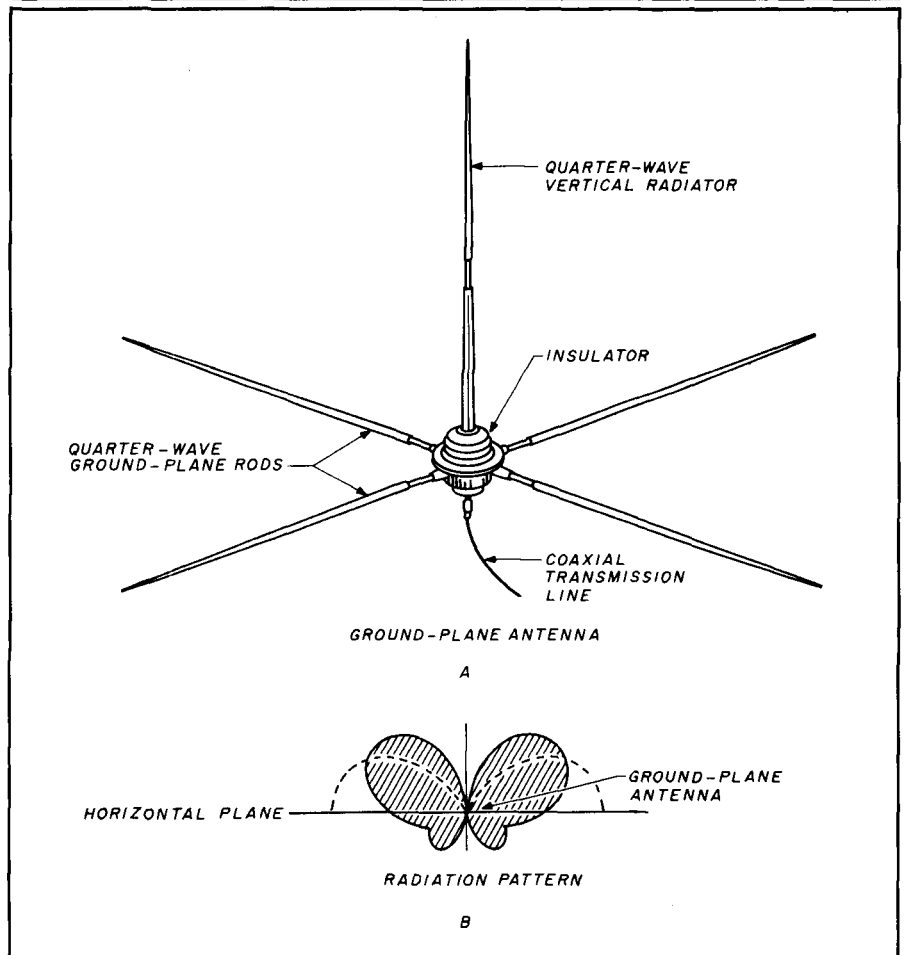

Diagram of a commercial ground plane with four radials mounted 90° apart.

there are both theoretical and practical limits to the number of radials. The theoretical limit is derived from the fact that more than 120 radials return practically no increase in operational effectiveness, and at more than 16 radials the returned added effectiveness per new radial is less than the case for fewer radials. That is, going from 16 to 32 radials (doubling the number) creates less of an increase in received field strength at a distant point than going from 8 to 16 radials (both represent doubling the density of the radial system).

The radials of the above-ground vertical antenna can be at any angle. In **Figure 2B** they are "drooping radials;" i.e., the angle is greater than 90 degrees relative to the vertical radiator element. Similarly, **Figure 2C** shows a vertical antenna equipped with radials at exactly 90 degrees. (No common antenna has radials of less than 90 degrees.) Both of these antennas are called ground-plane vertical antennas.

The angle of the radials is said to affect the feedpoint impedance and the angle of radiation of the vertical antenna. While those statements are undoubtedly true in some sense, there are other factors that also affect those parameters and are probably more important in most practical installations. Before digging further into the subject of vertical antennas, let's take a look at the subjects of angle of radiation and gain in vertical antennas.

Angle of radiation

Long distance propagation in the HF region depends upon the ionospheric phenomena called "skip." In this type of propagation, the signal leaves the transmitting antenna at angle a , called the angle of radiation, and enters the ionosphere where it is refracted back to earth at a distance from the transmitting station. The signal in the zone between the outer edge of the antenna's ground wave region and the distant skip point is weak or nonexistent.

The distance covered by the signal on each skip is a function of the angle of radiation. **Figure 3** shows a plot of the angle of radiation of the antenna, and the distance to the first skip zone. The angle referred to along the vertical axis is the angle of radiation away from the antenna relative to the horizon. For example, an angle of 30

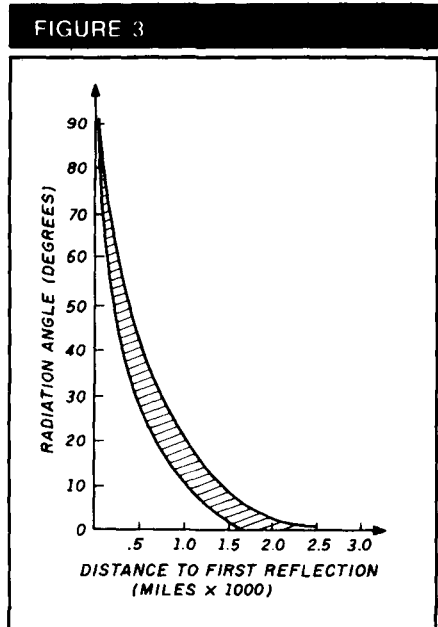

Graph of skip zone versus angle of radiation.

degrees is elevated above the horizon 10 degrees. Shorter distances are found when the angle of radiation is increased. At an angle of about 30 degrees, for example, the distance per skip is only a few hundred miles.

Although you might expect to see a single line on the graph, there's actually a zone shown (shaded). This phenomenon exists because the ionosphere is found at different altitudes at different times of the day and different seasons of the year. Generally, however, in the absence of special event phenomena in the ionosphere, expect from 1500 to 2500 miles per bounce in the HF bands for low angles of radiation. Note, for example, that for a signal that's only a degree or two above the horizon, the skip distance is maximum.

At distances greater than those shown in **Figure 3**, the signal will make multiple hops. Given a situation where the skip distance is 2500 miles, covering a distance of 7500 miles requires three hops. Unfortunately, there's a signal strength loss of 3 to 6 dB on each hop, so you can expect the distant signal to be attenuated from making multiple hops between the earth's surface and the ionosphere. For maximizing distance, the angle of radiation needs to be minimized.

So what's the ideal angle of radiation? It's standard — but actually erroneous — wisdom among Amateur Radio operators (and even commercial operators, it turns out) that the lower

the angle of radiation the better the antenna. This statement is only true if you're looking for long distance, so it reflects a strong bias toward the DX community. The correct answer to the question is: "It depends on where you want the signal to go." For example, I live in Virginia. If I want to work stations in the Carolinas or New England, it would behoove me to select a high angle of radiation for radio conditions represented in **Figure 3**, so that the signal will land in those regions. But if I want to work stations in Europe, Africa or South America, then a lower angle of radiation is required. Because of the difference between performance of high and low angles of radiation, some stations have two antennas for each band — one each for high and low angles of radiation.

Figure 4 shows a signal from a hypothetical antenna located at point O to show what angle is meant by angle of radiation. The beam from the

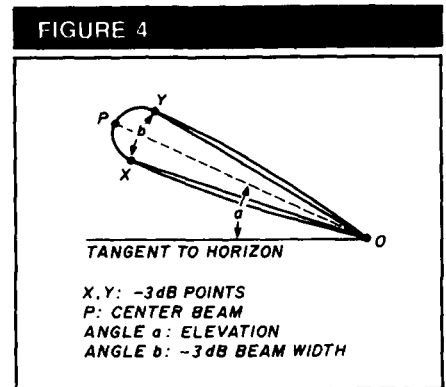

Diagram illustrating angle of radiation.

antenna is elevated above the horizon (represented by the horizontal "tangent to horizon" line). The angle of radiation, a , is the angle between the tangent line and the center of the beam. This angle is not to be confused with the beamwidth, which is also an angle. In the case of beamwidth, I'm talking about the thickness of the main lobe of the signal between points where the field strength is 3 dB down from the maximum signal (which occurs at point P); these points are represented by points x and y in **Figure 4**. Thus, angle b is the beamwidth, while angle a is the angle of radiation.

Gain in vertical antennas

Vertical antennas are known as omnidirectional because they radiate equally well in all directions. Gain in an



the HAM STATION

P.O. Box 6522
220 N. Fulton Ave.
Evansville, IN 47719-0522

Store Hours
MON-FRI: 9AM - 6 PM
SAT: 9AM - 3 PM
CENTRAL TIME

SEND A SELF ADDRESSED STAMPED
(50¢) ENVELOPE (SASE) FOR NEW AND
USED EQUIPMENT SHEETS.

WARRANTY SERVICE CENTER FOR:
ICOM, YAESU, TEN-TEC

FOR SERVICE INFORMATION CALL
(812) 422-0252
FAX 812-465-4449
MONDAY - FRIDAY
9:00 AM - 12:00 NOON

TERMS:

Prices Do Not Include Shipping.
Price and Availability Subject to
Change Without Notice

Most Orders Shipped The Same Day
COD's Welcome (\$3.50 + shipping)



YAESU



FT-747GX

- 100 Watts of Economical Performance
- Dual VFO's, 20 Memories
- Receives from 100 kHz - 30 MHz
- Built-In CW Filter + More

FT-470

COMPACT 2M/70CM
DUAL BAND FM



- Simultaneous Reception on Both Bands
- Up to 5 Watts Output
- 21 Memories on Each Band
- Built-in 10 Memory DTMF Auto Dialer
- Built-in CTCSS PLUS MORE!

concept

VHF/UHF AMPS



- High VSWR and Overdrive Protection
- 5 Year Warranty, 6 Months on RF Transistors
- All Units have GaAsFET Receive Pre-amps

ICOM

IC-32AT

- New Dual Band HT
- RX-138-174 MHz 440-450 MHz
- TX-140-150 MHz 440-450 MHz
- 5 Watts Output on Both Bands
- Full Duplex & 20 Memories



IC-2SAT

- NEW 2 Meter Handheld
- Ultra Small HT with up to 5 Watts Output
- VFO Scan & Memory Scan
- 48 Programmable Memories
- Covers 140-150 MHz



ALINCO

DR-110T

- NEW 2 Meter Mobile
- 45 Watts Output
- 14 Memories with Standard Encode/Decode Subaudible Tones
- CAP and MARS Modifiable



Heath



SB-1000

- HF Linear Amp (kit)
- 1000W Output on SSB, 850 on CW, 500 W on RTTY
- Covers 160-15 Meters
- 1,3-500Z Tube
- QSK with Optional Board

HK-21

POCKET PACKET TNC



- Miniature Sized VHF/UHF Modem
- TNC-2 Compatible
- Personal Bulletin Board
- All Cables Supplied
- Connect to Your V/UHF Radio and RS-232 Computer and Your Set.



OMNI V



- New U/LSB, QSK, CW, FSK HF Rig
- Dual VFO's, 100 W Output
- Allbands 160-10
- Superior "Phase Noise"
- Made in USA

ORDERS & PRICE CHECKS

800-729-4373

LOCAL INFORMATION

812-422-0231

VHF-UHF POWER DIVIDERS



RF power dividers provides the best way to feed in-phase 2 and 4 antenna arrays to maximize system gain and at the same time reduce losses to a minimum. Covering 144 thru 1296 MHz, this series of VHF/UHF power dividers are premier RF devices designed for a long service life with low SWR and broad operating bandwidth.

Extruded aluminum body with a durable enamel finish in addition to silicon sealing at connector flanges results in a ruggedized unit for all array installations. Available with N-type connectors only, these units are unconditionally guaranteed for 2 years.

MODEL	CONFIG.	PRICE
144-2P	(2 ports)	\$54.00
144-4P	(4 ports)	\$61.00
220-2P	(2 ports)	\$53.00
220-4P	(4 ports)	\$60.00
430-2P	(2 ports)	\$51.00
430-4P	(4 ports)	\$59.00
902-2P	(2 ports)	\$51.00
902-4P	(4 ports)	\$59.00
1296-2P	(2 ports)	\$52.00
1296-4P	(4 ports)	\$60.00

SHIPPING NOT INCLUDED

STRIDSBURG ENGINEERING, CO.

P.O. Box 7973 • Shreveport, LA 71107 • USA
Phone: (318) 865-0523

Amplifier Repair

Alpha - Ameritron - AMP - Henry
Dentron - Heathkit - TenTec - Etc.

35 Years Experience as the
Service Manager with a
major manufacturer

Authorized
TenTec
Dealer

K4BWC



Visa & MasterCard

OMEGA ELECTRONICS

4209 Live Oak Road
Raleigh, NC 27604
919-832-1025

165

QEX

The ARRL
Experimenters' Exchange and
AMSAT Satellite Journal

QEX is a no-nonsense Amateur Radio magazine that will provide you with a monthly supply of useful technical information. As an *exchange*, it is written by and for serious experimenters.

Feature articles cover a wide variety of subjects such as VHF-microwave, analog and digital design, software, space experiments, propagation research, construction projects and so forth. Articles are presented in the same language used by experimenters.

Because QEX is an *exchange*, regular reader input and participation is welcomed; here's your chance to make your contribution. If you're an active experimenter working close to the state of the art and want to "network" with others, you need QEX and QEX needs you.

Monthly. For 12 issues to ARRL members: US, \$10; Canada and Mexico by first class mail \$18; Elsewhere by airmail \$38. Non-members add \$10 to these rates.

THE AMERICAN RADIO RELAY LEAGUE
225 MAIN ST.
NEWINGTON, CT 06111

166

RAMSEY ELECTRONICS

Quality Test Gear & Electronic Kits for Professionals and Hobbyists

ALL NEW KITS



COM-3
\$2795.00
THE COMMUNICATIONS SERVICE MONITOR THAT WORKS HARDER FOR LESS.
 Introducing COM-3... the new service monitor designed by service technicians for service technicians. It works harder for less... giving you advanced testing capabilities at a very affordable price.
FEATURES: Direct entry keyboard with programmable memory • Audio & transmitter frequency counter • LED bar graph frequency/error deviation display • 0.1-10,000 µV output levels • High receive sensitivity, less than 5µV • 100 KHz to 999.9995 MHz Continuous frequency coverage • Transmit protection, up to 100 watts • CTS tone encoder, 1 KHz and external modulation



PR-2 COUNTER PREAMP
 The PR-2 is ideal for measuring weak signals from 10 to 1,000 MHz • flat 25 db gain • BNC connectors • great for sniffing RF • ideal receiver/TV preamp • 3 db NF
\$4995
 wired Includes AC adapter
 PR-2 kit \$39.95



PS-2 AUDIO MULTIPLIER
 The PS-2 is handy for high resolution audio resolution measurements, multiplies up in frequency • great for PL tone measurements • multiplies by 10 or 100 • 0.01 Hz resolution & built-in signal preamp/conditioner
\$6995
 wired PS-2 kit \$49.95



PS-10B 1.5 GHz PRESCALER
 Extends the range of your present counter to 1.5 GHz • 2 stage preamp • divide by 1000 circuitry • super sensitive (50 mv typical) • BNC connectors • 1.5 GHz in, 1.5 MHz out • drives any counter
\$8995
 wired Includes AC adapter



SPEEDY Complete kit, SO-7
\$89.95
PERSONAL SPEED RADAR

New low cost microwave doppler radar kit "clocks" cars, planes, boats, horses, bikes, baseballs, missiles, runners or virtually anything that moves. Operates at 2.6 GHz with over 1/4 mile range. LED digital readout displays speeds in miles per hour, kilometers per hour or feet per second. Earphone output permits listening to actual doppler shift. Uses two 1 lb coffee cans for antenna (not included) and runs on 12 VDC. Easy to build—all microwave circuitry is PC stripboard. Kit includes deluxe ABS plastic case with speedy graphics for a professional look. A very useful and full-of-fun kit.

RADIOS

40 & 80 METERS HAM RECEIVERS

Sensitive all mode AM, CW, SSB receivers for 3.5-4.0 or 70-75 MHz. Direct conversion design using NE602 IC as featured in QST and ARRL handbooks. Less than 1µV sensitivity, varactor diode tuned, 50 mw audio output. Runs on 9VDC, has RF gain control. This kit is very easy to build, lots of fun and educational—ideal for the beginner or the old pro. The optional matching case kit features a rugged ABS plastic case with screened graphics. Included are machined aluminum knobs for a well-finished professional look.
 40 Meter receiver kit, HR-4 **\$24.95** 80 Meter receiver kit, HR-6 **\$24.95** Receiver case kit, CHR **\$12.95**

QRP TRANSMITTER KITS, 40 & 80 METERS

Operate a mini ham shack. These little CW rigs are ideal mates to our 40 and 80 meter receivers. Features include smooth variable tuning, one watt output and excellent frequency characteristics. Runs on 12 VDC and is VSWR protected. See how far you can stretch your signal with one of these mini rigs. Optional ABS cases are available.
 40 meters QRP rig, DRP-40 **\$24.95** 80 meters QRP rig, DRP-80 **\$24.95** Case kit, CGRP **\$12.95**

AIRCRAFT RECEIVER KIT

Hear exciting aircraft communications—picks up planes up to 100 miles away. Receives 110-130 MHz AM air band, varactor tuned superhet design with AGC, ceramic filter and adjustable squelch. Runs on 9V battery. 50 mw audio output. 1µV sensitivity. Optional matching ABS plastic case lets you take it anywhere. Features screened graphics and machined aluminum knobs for a real professional look. Compact—great for airshows or for just plain hanging around the airport.
 Complete kit, AR-1 **\$24.95** Receiver case kit, CAR-1 **\$12.95**

SHORTWAVE RECEIVER KIT

A fantastic receiver that captures the world with just a 12' antenna! Receives 4-11 MHz in 2 MHz bands, varactor tuned, superhet design with AGC, RF gain control, and 50 mw audio output. Uses new Synetics mixer chip for less than a microvolt sensitivity. Runs on 9V battery. This is a fascinating scout, school or club project, and will provide hours of fun even to the most serious DX'er. Add the optional case kit and you have a real nice looking shortwave set.
 Complete kit, CSR-1 **\$24.95** Receiver case kit, CSR-1 **\$12.95**

PACKET RADIO

Commodore 64/128 packet radio interface. Uses famous German Digicom software. Features EXAR IC chip set for reliable operation—runs HF or VHF tones. Includes FREE disk software. PC board—all necessary parts and full documentation.
 Complete kit, PG-1 **\$49.95**

FM COMMUNICATIONS/2 METER RECEIVER

Sensitive superhet FM receiver tunes any 5 MHz segment from 135-175 MHz. Listen to 2 mtr ham operations, high band police calls, weather or mobile phone calls! Easy to build receiver features varactor tuning, IC mixer stage, ceramic IF filters and dual conversion design with adjustable squelch. Less than 1µV sensitivity, runs on 9 V battery, with 50 mw audio output. Optional ABS case with screened graphics and machined aluminum knobs provide a nice professional look.
 Complete kit, FR-7 **\$29.95** Receiver case kit, CFR-7 **\$12.95**

NEW MINIKITS—NEW MINIKITS

BROADBAND PREAMP A sensitive all purpose preamp, ideal for scanners, TV sets, VHF, UHF rigs, counters, etc. Features low noise, 4 db NF, 20 db gain, 100 KHz—1 GHz operation. Runs on 9-12 VDC, 50 ohms input. Complete kit, SA-7 \$12.95	LIGHT BEAM COMMUNICATORS Transmits modulated infrared light up to 30 feet without lenses, up to 1/4 mile using lenses. Uses 30 KHz carrier for hum-free operation. Transmits thru windows, etc. Ideal for "bugs" or listening to IR remote controls. Transmitter has sensitive mike input, receiver uses PM detector and drives speaker output. Units operates on 9-12 VDC. Transmitter kit, LB-6 \$8.95 Receiver kit, LB-5 \$9.95	HIGH POWER FM WIRELESS MIKE A high power unit that will transmit up to 1/2 mile to any FM broadcast radio. Sensitive input accepts any type of mike, will pick up normal voices 10 feet away using the available mini-electric mike cartridge. Operates on 9-12 VDC. FM-4 kit \$9.95 Sensitive microphone cartridge \$2.95
---------------------------------------------------------------------------------------------------------------------------------------------------------------------------------------------------------------------------------------------------------------	------------------------------------------------------------------------------------------------------------------------------------------------------------------------------------------------------------------------------------------------------------------------------------------------------------------------------------------------------------------------------------------------------------------------------------------------------------------	----------------------------------------------------------------------------------------------------------------------------------------------------------------------------------------------------------------------------------------------------------------------------------------------------------------------------------------------------------

2 MTR & 220 BOOSTER AMP

Here's a great booster for any 2 meter or 220 MHz hand-held unit. These power boosters deliver over 30 watts of output allowing you to hit the repeaters full quieting while the low noise preamp remarkably improves reception. Ramsey Electronics has sold thousands of 2 mtr amp kits but now, we offer completely wired and tested 2 mtr as well 220 MHz units. Both have all the features of the high priced boosters at a fraction of the cost.

30 WATT OUTPUT LOW NOISE PREAMP LOW COST RUGGED CAST ALUMINUM CASE ONE YEAR WARRANTY	PA-10 2 MTR POWER BOOSTER (10 X power gain) Fully wired & tested \$59.95 PA-20 220 MHz POWER BOOSTER (8 X power gain) Fully wired & tested \$59.95
-------------------------------------------------------------------------------------------------------------------------------------	-----------------------------------------------------------------------------------------------------------------------------------------------------------------------------------------------------

CT-70 7 DIGIT 525 MHz CT-90 9 DIGIT 600 MHz



\$139.95 WIRE INCLUDES AC ADAPTER
\$169.95 WIRE INCLUDES AC ADAPTER



\$189.95 WIRE INCLUDES AC ADAPTER
\$189.95 WIRE INCLUDES AC ADAPTER

MODEL	FREQ RANGE	SENSITIVITY	ACCURACY	DIGITS	RESOLUTION	PRICE
CT-70	20 Hz-550 MHz	< 50 mv to 150 MHz	1 PPM	7	1 Hz, 10 Hz, 100 Hz	139.95
CT-90	10 Hz-600 MHz	< 10mv to 150 MHz < 150mv to 600 MHz	1 PPM	9	0.1 Hz, 10 Hz, 100 Hz	169.95
CT-50	5 Hz-600 MHz	LESS THAN 25 mv	1 PPM	8	1 Hz, 10 Hz	189.95
CT-125	10 Hz-1.25 GHz	< 25mv @ 50 MHz < 15mv @ 500 MHz < 100mv @ 800 MHz	1 PPM	9	0.1 Hz, 1 Hz, 10 Hz	189.95
CT-90 WITH OV-1 OPTION	10 Hz-600 MHz	< 10mv to 150 MHz < 150mv to 600 MHz	0.1 PPM	9	0.1 Hz, 1 Hz, 10 Hz	229.90

FREQUENCY COUNTERS

Ramsey Electronics has been manufacturing electronic test gear for over 30 years and is recognized for its lab quality products at breakthrough prices. All of our counters carry a full one year warranty on parts and labor. We take great pride in being the largest manufacturer of low cost counters in the entire USA. Compare specifications. Our counters are full featured, from audio to UHF, with FET high impedance input, proper wave shaping circuitry and durable high quality epoxy glass, plated thru PCB construction. All units are 100% manufactured in the USA.

ACCESSORIES FOR COUNTERS

- Telescopic whip antenna—BNC plug **\$ 8.95**
- High impedance probe, light loading **18.95**
- Low pass probe, audio use **16.95**
- Direct probe, general purpose use **13.95**
- Trit ball for CT-70, 90 & 125 **3.95**
- Nicad pack for CT-70, 90 & 125 **8.95**

MINI KITS—EASY TO ASSEMBLE—FUN TO USE

TONE DECODER A complete tone decoder on a single PC board. Features: 400-5000 Hz adjustable range via 20 turn pot, voltage regulation, 567 IC. Useful for touch-tone burst detection, FSK, etc. Can also be used as a stable tone encoder. Runs on 3 to 12 volts. Complete kit, TD-1 \$5.95	COLOR ORGAN See music come alive! 3 different lights flicker with music. One light each for high, mid-range and lows. Each individually adjustable and drives up to 300 W. runs on 120VAC. ML-1 kit \$8.95	VIDEO MODULATOR Converts any TV to video monitor. Super stable, tunable over ch 4-6. Runs on 15V. accepts kirt video signal. Best unit on the market! Complete kit, VD-1 \$7.95	FM WIRELESS MIKE Transmits up to 300' to any FM broadcast radio using any type of mike. Runs on 3 to 9V. Type FM-2 has added sensitive mike preamp stage. FM-1 kit \$3.95 FM-2 kit \$4.95
40 WATT 2 mtr PWR AMP Simple Glass C power amp features 8 times power gain 1 W in for 8 out, 2 W in for 20 out, 5 W in for 40 W out. Max output of 50 W, incredible value, complete with all parts, less case and 1 R relay. PA-1: 40 W pwr amp kit \$27.95 TR-1: RF-Sensed 1 R relay kit 6.95	VOICE ACTIVATED SWITCH Voice activated switch kit provides switched output with current capability up to 100 mA. Can drive relays, lights, LED or even a tape recorder motor. Runs on 9 VDC. VS-1 kit \$6.95	LED BLINKY KIT Alternately flashes 2 junction LEDs. Use for name badges, buttons, warning panel lights. Runs on 3 to 15 volts. BL-1 kit \$2.95	MAD BLASTER Produces LOUD ear shattering and aftertongue getting siren like sound. Can supply up to 15 watts of obnoxious audio. Runs on 6-15 VDC. MB-1 kit \$4.95
UNIVERSAL TIMER Provides the basic parts and PC board required to provide a source of precision timing and pulse generation. Uses 555 timer IC and includes a range of parts for most timing needs. UT-5 kit \$5.95	WHISPER LIGHT An interesting kit, small mike picks up sounds and converts them to light. The louder the sound, the brighter the light. Includes mike, controls up to 300 W. runs on 110 VAC. WL-1 kit \$6.95	SIREN Produces upward and downward wail. 5 W peak audio output, runs on 3-15 volts, uses 3-45 ohm speaker. Complete kit, SM-3 \$2.95	FM MINI MIKE A super high performance FM wireless mike kit. Transmits a stable signal up to 300 yards with exceptional audio quality by means of its built in electret mike. Kit includes case, mike, on-off switch, antenna, battery and super instructions. This is the finest unit available. FM-3 kit \$14.95 FM-3 Wired and Tested Complete Kit, MD-3 \$16.95

SUPER SLEUTH A super sensitive amplifier which will pick up a pin drop at 15 feet! Great for monitoring baby's room or as general purpose amplifier. Full 2W rms output, runs on 6 to 15 volts, uses 8-45 ohm speaker. BN-9 kit \$5.95	TELEPHONE TRANSMITTER Low cost with professional performance. Features include: self phone line powered, tunable from 76 to 100 MHz, polarity antensitive, compact size (1" x 1 1/2"), easily installs anywhere on the phone line or inside the instrument itself! PB-1 kit \$14.95	FM RECEIVER For built-in applications or hobby experimentation. Full fledged super-heterodyne receiver, microvolt sensitivity, 10.7 MHz IF. Integrated Circuit detector, 50 mw audio amplifier, 9V external power source, operation on standard FM broadcast band as well as large portions on each side, compact (6" square), for bug detection or reception. FR-1 kit \$14.95	NEW NEW MICROWAVE INTRUSION ALARM A real microwave doppler sensor that will detect a human as far as 10 feet away. Operates on 1.3 GHz and is not affected by heat, light or vibrations. Drives up to 100 ma output, normally open or closed, runs on 12 VDC. Complete Kit, MD-3 \$16.95	SPEECH SCRAMBLER Communicate in total privacy over your telephone or radio. This scrambler kit features full duplex operation using frequency inversion. Runs on a 9 volt battery. Both mike and line or speaker output/inputs. Easy to connect to any radio—telephone use requires no direct connection! Easy to build, uses IC ODM circuitry. Can also be used to descramble most com. scramblers. Complete kit, SS-7 Case, CSS-7 \$29.95
------------------------------------------------------------------------------------------------------------------------------------------------------------------------------------------------------------------------------------------------------------	---------------------------------------------------------------------------------------------------------------------------------------------------------------------------------------------------------------------------------------------------------------------------------------------------------	-----------------------------------------------------------------------------------------------------------------------------------------------------------------------------------------------------------------------------------------------------------------------------------------------------------------------------------------------------------------------------------------------------	------------------------------------------------------------------------------------------------------------------------------------------------------------------------------------------------------------------------------------------------------------------------------------------------------------------------	-----------------------------------------------------------------------------------------------------------------------------------------------------------------------------------------------------------------------------------------------------------------------------------------------------------------------------------------------------------------------------------------------------------------------------------------------------------------

TERMS: • satisfaction guaranteed • examine for 10 days; if not pleased, return in original form for refund • add 6% for shipping and insurance to a maximum of \$10.00 • foreign add 15% for surface mail • COD add \$2.50 (COD in USA only) • orders under \$20.00 add \$1.50 • NY residents add 7% sales tax • 90 days parts warranty on all kits • 1 year parts & labor warranty on all wired units.

PHONE ORDERS CALL 716-586-3950
FAX 716-586-4754

RAMSEY ELECTRONICS, INC., 2575 Baird Rd., Penfield, N.Y. 14526

FIGURE 5

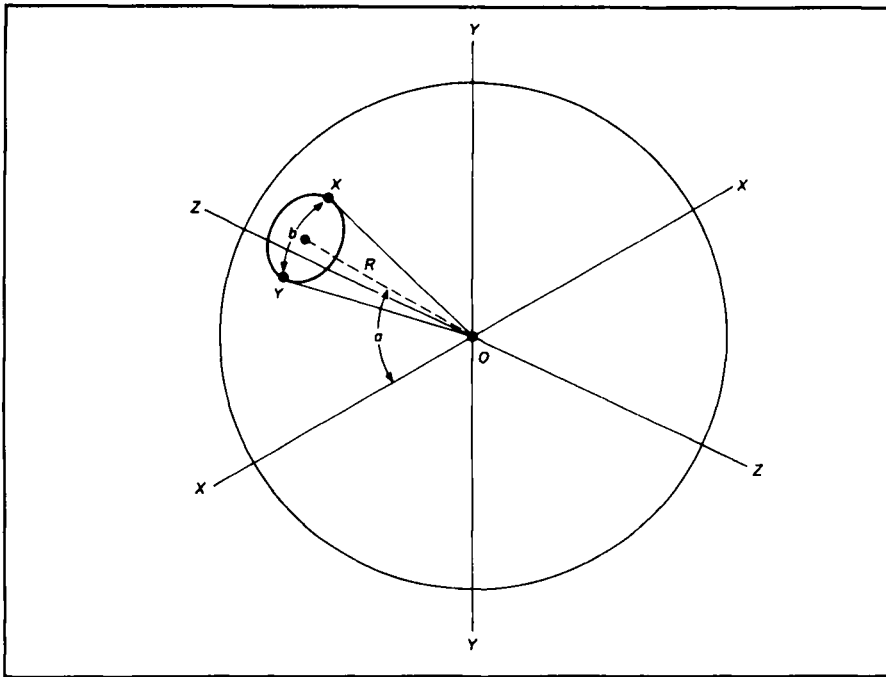

Diagram of a theoretical isotropic radiator.

from the transmitter, it will be spread equally well over the entire surface of the sphere as it radiates out into space away from point O. If you measure the power distributed over some area, A, at a distance, R, from the source, then the power available will be a fraction of the total power.

$$P_{avail} = \frac{\text{Total Available Power} \times \text{Area "A"}}{\text{Total Surface Area of Sphere}} \quad (1)$$

or, in math symbols, we can write the expression:

$$P_a = \frac{P_s}{4\pi r^2} \quad (2)$$

Where:

P_a is the power available per solid degree

P_s is the total radiated power in watts

R is the radius of the sphere, i.e., the distance from O to P.

A practical rule of thumb for this problem is to calculate from the surface area of the sphere. If you perform the right calculations, you'll find that there are approximately 41,253 square degrees on the surface of a sphere. By calculating the surface area of the beam front (also in square degrees), you can find the power within that region.

Now for the matter of gain in a vertical antenna. The vertical isn't gainless because it doesn't radiate equally well in all directions. In fact, the vertical is quite directional except in the horizontal (azimuth) plane. Figure 6 shows the radiation pattern of the typical vertical radiator. The pattern looks like a giant doughnut in free space (see solid pattern in Figure 6). When sliced like a bagel, the pattern is the familiar circular omnidirectional pattern. When examined in the vertical plane, however, the plane looks like a sliced figure eight. The gain comes from the fact that energy isn't spread over an entire sphere, but concentrated to the toroidal doughnut-shaped region shown. Therefore, the power per unit area is greater than for the isotropic (truly omnidirectional) case.

Non quarter-wavelength verticals

The angle of radiation for a vertical antenna, hence the shape of the hypothetical doughnut radiation pat-

FIGURE 6

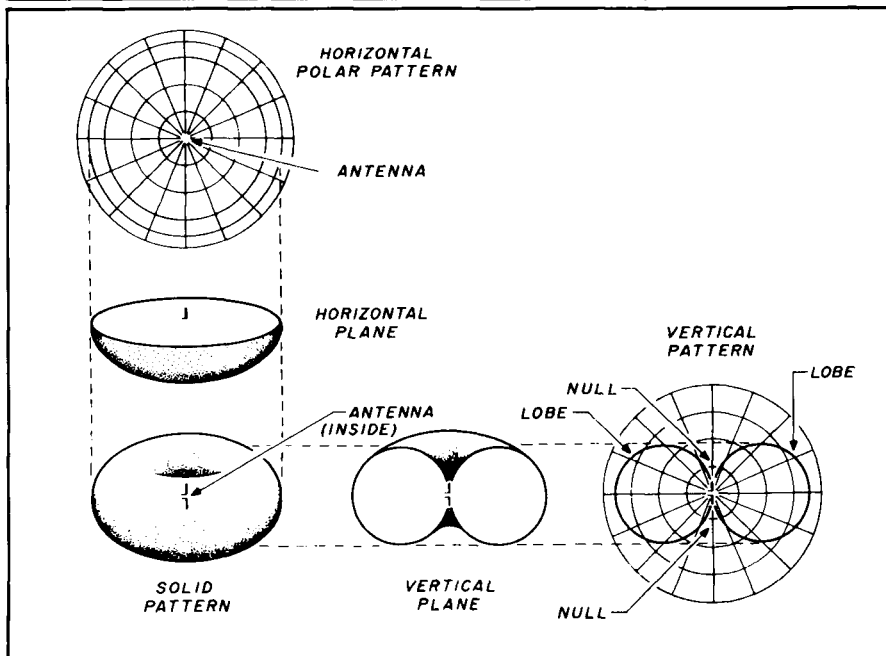

E and H plane patterns of a typical vertical.

antenna is not the creation of power, but rather a simple refocusing of energy from all directions to a specific one. Therefore, gain implies directivity. According to the convention, then, the vertical antenna can't have any gain because it radiates in all directions equally, and gain implies directivity.

Right? No, not really. Let's develop the theme more carefully.

Again consider the idea of an isotropic radiator (the word "isotropic" means equal power in all directions). Consider a spherical point source radiator located at point O in Figure 5. Whatever the level of power available

COMPUTER SOFTWARE

LOW BAND DX-ING COMPUTER PROGRAMS

by John Devoldere, ON4UN - 30 programs for Apple II, MS-DOS, Commodore C-128 and Kaypro CPM Computers

Just about every interest or need is covered—from antenna design and optimization to general operating programs. Antenna programs include: shunt and series input L network design, feedline transformer, shunt network design, SWR calculation, plus 11 more! General Ham programs include: sunrise/sunset, great circle distances, grayline, vertical antenna design program, sunrise calendar plus 9 more! © 1986.

- UN-Apple II \$39.95
- UN-MS (MS-DOS) \$39.95
- UN-CPM/Kaypro \$39.95
- UN-C-128 (COMMODORE C128) \$39.95
- UN-MAC (MACINTOSH) \$49.95

N6RJ's ELECTRONIC SECOND OP for MS-DOS computers, V1.01

by Jim Rafferty N6RJ

The world famous SECOND OP is now available in a state-of-the-art computerized data base. This program, written for MS-DOS computers, is a must for DX'ers, contesters and all Amateurs interested in reliable DX communication. Data can be displayed either in columnar format or in full screen displays. Unknown call signs can be entered and compared to the ITU call sign allocation for easy identification. There's plenty more too such as: postal rates, beam headings and QSL bureaus to name just a few. Great program to have in your shack. Order your's today. ©1988. MS-DOS computers. 5/4 and 3/2 versions available. Please specify on your order.

- CB-RJ (MS-DOS Computers) \$59.95

**HAM
DATA**

By
**Chip Lohman
NN4U** FOR C-64
AMATEUR RADIO COMPUTER SOFTWARE

MASTER LOG New Version

Master Log creates a file of 2100 individual records with up to 13 different entries per record. It can do a search and select based upon time, frequency, mode and keeps track of DXCC and WAS status, prints QSL labels and can search its whole file in less than 5 seconds! Complete documentation is included to help you learn and use this truly state-of-the-art logging program. ©1988.

- HD-ML (For C-64) \$28.95

SUPER LOG

Super Log gives you all the advantages of a computerized data base without significantly changing the traditional log format. Super Log also allows you to print out either selected contents or the whole log. Will print QSLs.

- HD-SL (For C-64) \$19.95

CONTEST LOG

This disk contains four different contest programs: ARRL Sweepstakes, Field Day, Universal WW Contest log, plus a dupe checking routine. Automatically enters date, time, band and serial number for each contact. When the contest is over, the program will print your results listing all duped and scored contacts in serial sequence with all the necessary information as well as completed score at the bottom of the page.

- HD-CL (For C-64) \$24.95

DX EDGE MS-DOS AND C-64 software

Particularly helpful in determining long path and grey line openings. Super fast speed and dazzling graphics make this program a treat to use. The MS-DOS version also includes a close up (zoom) feature for detailed examination, a MUF calculator and a great circle bearing routine. All call sign prefixes and country names are built into the data base for easy pinpointing of locations. MS-DOS version also color compatible. Requires 2 disk drives, 348k of memory, Hercules, CGA or EGA graphics and DOS 2.1 or later.

- XN-DOS (IBM or compatible computers) \$34.95
- XN-C64 (C-64 computer) \$34.95
- XN-DX (slide rule version) \$22.95

HAM RADIO'S BOOKSTORE

Please enclose \$3.75 shipping and handling.

Greenville, NH 03048

(603) 878-1441

FIGURE 7A

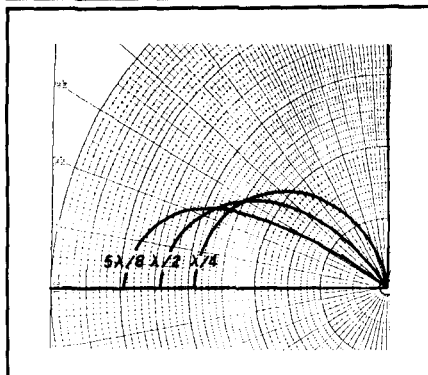

Approximate patterns for three different length verticals. Relative power gains are also visible.

tern, is a function of the antenna length. (Note: "length" in terms of vertical antennas is the same as "height," and is sometimes expressed in degrees or wavelength, as well as feet and/or meters). Figure 7A shows the approximate patterns for three different length vertical antennas: quarter wavelength, half wavelength, and 5/8 wavelength. Note that the quarter-wavelength antenna has the highest angle of radiation, as well as the lowest gain of the three cases. The 5/8-wavelength antenna has both the lowest angle of radiation and the highest gain (compared with isotropic).

The patterns shown in Figure 7A assume a perfectly conducting ground underneath the antenna. However, that's not a possible situation for practical antennas — all real grounds are lossy. The effect of ground loss pulls the pattern in close to the ground (Figure 7B). Although all of the patterns are elevated from those of Figure 7A, the relationships still remain. The 5/8-wavelength radiator has the lowest angle of radiation and highest gain.

The feedpoint impedance of a vertical antenna is a function of the radiator length. For the standard quarter-wavelength antenna, the feedpoint radiation resistance is approximately 37 ohms, with only a very small reactance component. Figures 8A and B show the approximate feedpoint impedances for antennas from nearly zero effective length to 120 degrees of length.

Antenna length as it is expressed in degrees derives from the fact that one wavelength equals 360 degrees. Thus, a quarter-wavelength antenna has a length of 360 degrees/4 = 90

FIGURE 7B

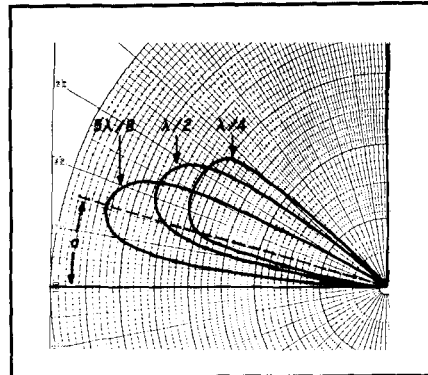

Effects of ground losses on the patterns of the same three antennas.

FIGURE 8A

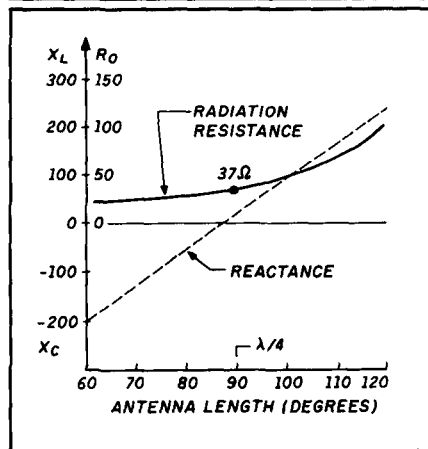

Approximate feedpoint impedances of antennas from 0° to 120° in electrical length.

FIGURE 8B

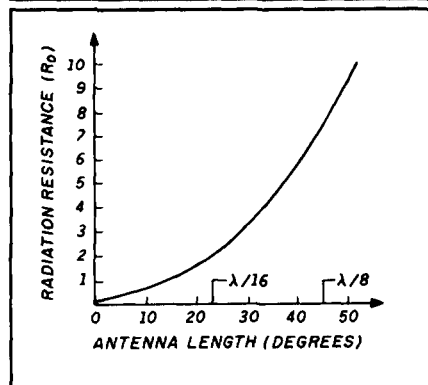

Radiation resistance of antennas from 0° to 60° in electrical length.

degrees. To convert any specific length from degrees to wavelengths, divide the length in degrees by 360. Thus, for a 90-degree antenna: 90 degrees/360 degrees = 1/4 wavelength. The graph in Figure 8A shows the antenna feed-

FIGURE 9

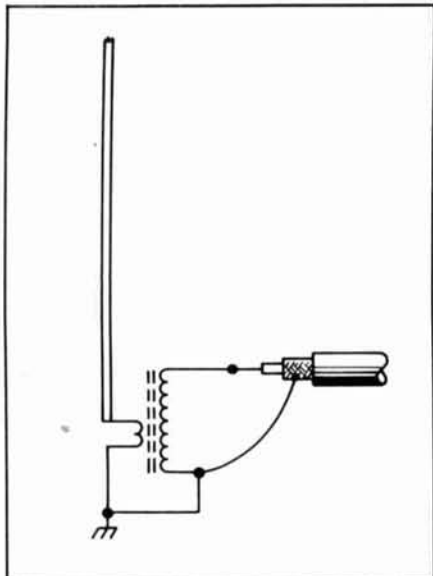

Basic connection of a toroidal transformer to a vertical antenna.

PHOTO A

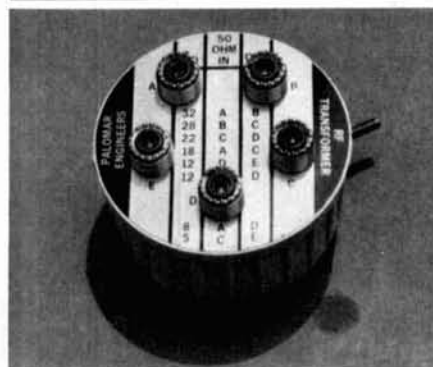

Commercial impedance matching transformer.

point impedance, both reactance and radiation resistance, for antennas from 60 to 120 degrees; **Figure 8B** shows the radiation resistance for antennas from near zero to 60 degrees. Note that the radiation resistance for such short antennas is extremely small. For example, an antenna that is 30 degrees long ($30/360 = 0.083$ wavelength) has a resistance of approximately 3 ohms.

It's generally the practice on vertical antennas with an impedance-matching problem to use a broadband impedance-matching transformer to raise the impedance of these antennas to a higher value. **Figure 9** shows the basic connection of the toroidal transformer to the vertical antenna. You can wind a homebrew transformer following instructions given in *The ARRL Handbook*, other publications, or a past issue of this column. You can also use a manufactured impedance transformer like the Palomar Engineers' model shown in **Photo A**. This transformer is designed specifically for HF vertical antennas.

Next month...

In the second installment of this three-part series I'll look at two topics: the installation of vertical antennas, and vertical antenna construction and mounting techniques.

I can be reached at POB 1099, Falls Church, Virginia 22041; I'd like to have your comments and suggestions for this column. 

HAM RADIO Sweepstakes Winners List

Grand Prize Winner

W2KQI

First Prize Winners

WA1QWG
KM4KU
AF3Z
KA9RHN
W4WZB
W3IFL
KA1DNB
W6DFG
WA2EXG
K9PQT
WA4GMX
N2CDR
WA0TRF
W3FZT
WA6CBQ
WA3END
W2SWA
WA2YNH
WA2VTP
K9FLX
W4JNK
WA2FEB
KA0SFV
WB3BEF
WA2SSJ
N0IBL
W0LOV
WB2EZX
WA9SFH
KU0L
W2URP
N3GIU
W6JEU
W4CVX
K7ZAB
WA9D
WA4SLE
KD3BZ
W4GDW
N5EGT
N1FMD
W0FSK
N4NFT
W3TOL
KC8MT
K1YVZ
W5JHY
KA1TW
W8BIT
K2DGW

N4QBK
N8HWH
NJ4R
WD4CBL
WB1FWS
N1AXR
W2CJ
K1WXY
N6FWS
KA1ONF
WF5R
KA1QQA
WA4DUP
K1VSJ
K1VUW
WB1GMH
KE3R
K1OPE
WB3EFQ
K1TGE
WA2TPU
K6QJ
W1FVY
WB9VFM
K2SYR
KB2LP
K1JG
WB2DJQ
WA3FIO
K3RMF
WA4RIP
K6MHQ
AH6CD
W6CKU
K2AGI
WA1GFY
WA5NPT
W0CSA
W2UJE
WA8ANP
W0DUI
W1VAB
KL7IF
K5SN
W5HSQ
WD0CYH
K4AOR
K7ERG
K9JPK
N9HCI

SERVICE MONITOR MEASUREMENTS MODEL FM 110

- Covers all business channels from 30MHz to 512MHz
- Monitor: 2uV, frequency error display, scope deviation display
- Generator: Calibrated output up to 10mV, Sinad display
- Built-in Tone Generator

AMAZINGLY LOW
PRICE OF ONLY

\$1685.00

FOB - BATESBURG, SC

WE ACCEPT VISA, MASTERCARD & AMERICAN EXPRESS

AIE CORPORATION — MEASUREMENTS DIVISION
PO BOX 70, BATESBURG, SOUTH CAROLINA 29006 (803)532-9256



WE SHIP WORLDWIDE

Barry Electronics Corp.

WORLD WIDE AMATEUR RADIO SINCE 1950

Your one source for all Radio Equipment!

For the best buys in town call:
212-925-7000
Los Precios Mas Bajos en Nueva York
WE SHIP WORLDWIDE!



MAY We Help You With the Best in Commercial and Amateur Radios?
Kitty WA 2BAP

KITTY SAYS: WE ARE NOW OPEN 7 DAYS A WEEK.
Saturday & Sunday 10 to 5 P.M.
Monday-Friday 9 to 6:30 PM Thurs. to 8 PM
Come to Barry's for the best buys in town.



ONV Safety belts-in stock

YAESU

FT-767GX, FT-757GXII, FT-747GX,
FRG-8800, FT-736R, FRG-9600,
FT-4700RH, FT-212/712RH, FT-470

YAESU
FT-23/73/33/727R
FT411-811
FT-1903/1123
FT-2005/7005

ICOM
IC2AT/12AT
IC02AT/32AT
IC2/4GAT
IC-A2/U16

Landmobile HT's
ICOM: U16, H16, V100, U400
MAXON, MOTOROLA,
YAESU: FTH 2005/2007
UNIDEN, REGENCY, KING,
MARINE ICOM: M5, M55, M700
AVIATION ICOM: A20, TAD



ICOM

IC-R71A, 751A, 781, 28A/H, 38A, 48A, Micro2/4,
R-7000, IC-765, IC-375A, 275A/H, 3210A, 475A/
H, 735, IC-900, IC-228H, IC725, IC448A



SMART PATCH

CES Simplex Autopatch 510 SA Will Patch FM
Transceiver To Your Telephone Great For
Telephone Calls From Mobile To Base Simple
To Use. 510SA/510SAII

KENWOOD



ANTENNAS
A-S, AES, Cushcraft, Hy-Gain,
Hustler, KLM, METZ,
MODUBLOX, TONNA,
Butternut, Multi-Band

TS440S/AT, R-5000, R-2000, TS-940 S/AT, TM
231A/431A, TM-2570A/50A/30A, TR-751A, Ken-
wood Service Repair, TM-721A, TS-711/811A,
TM3S30A, TH205AT, TH215A, TM-621A, TM-
321A, TS140S, TS680S, RZ-1, TS-790A.

Budwig ANT. Products
NEL-TECH DVK-100 Digital Voice Keyer
FLUKE 77, 83, 85, 87 Multimeters

Media Mentors—
Amateur Radio Course

VoCom/Mirage/Alinco
Tokyo Hy-Power/TE SYSTEMS
Amplifiers &
5/8λ HT Gain
Antennas IN STOCK

MICROLOG-ART 1, Air Disk,
SWL, Morse Coach

Professional
Soldering
Station
48 Watts
\$79

METRON
KW HF Mobile
Amplifier
Stocked

Alpha Delta
Products
Stocked



EIMAC
3-500Z
572B, 6JS6C
12BY7A &
6146B

AEA 144 MHz
AEA 220 MHz
AEA 440 MHz
ANTENNAS
BIRD
Wattmeters &
Elements
In Stock

AR 900 Hand Held Scanner 100
ch. Covers 27-54, 108-174,
406-512, 800-950 MHz



AMPLIFIERS
STOCKED:
RF Concepts
Mirage
TE Systems



IC-32AT



Motorola
Radius P-100



TH-75AT



FT-470

ALINCO
DJ-500T, DR-110T



Computer Interfaces
Stocked: MFJ-1270B,
MFJ-1274, MFJ-1224, AEA
PK-88, MFJ-1278, PK-232
W/FAX

FREQUENCY
COUNTERS:
1MHz-1.3GHz

COMMERCIAL
& HAM
REPEATERS
STOCKED.
WRITE FOR
QUOTES

MOTOROLA AUTHORIZED DEALER
KACHINA COMMUNICATIONS DEALER

AUTHORIZED
SONY
DEALER

DIGITAL FREQUENCY COUNTERS
Opto Electronics model 1300H, 0-1300MHz
Long-range Wireless
Telephone for export in stock

BENCHER PADDLES,
BALUNS, LOW PASS FILTERS
IN STOCK

MIRAGE AMPLIFIERS
ASTRON POWER SUPPLIES
Saxton Wire & Cable, Int'l Wire

OPTO KEYERS STOCKED



Kantronics
UTU, KAM, KPC II,
KPC 2400, KPC IV,
KAM



Covercraft, Coaxseal Stocked
SHORTWAVE RECEIVERS
STOCKED



Ten-Tec
Tuner 238

Radios for Business,
Gov't, 2-way, etc.
Stocked & serviced,
call for great prices!

COMET ANTENNAS
STOCKED

HEIL
EQUIPMENT
IN STOCK

SANGEAN Portable Shortwave Radios



New TEN-TEC
Corsair II, PARAGON,
OMNI V

IX Towers, Antennas,
Mobile Radio mounts
stocked. Call.

AMERITRON AUTHORIZED DEALER

MAIL ALL ORDERS TO: BARRY ELECTRONICS CORP., 512 BROADWAY, NEW YORK CITY, NY 10012 (FOUR BLOCKS NORTH OF CANAL ST.)

New York City's LARGEST STOCKING HAM DEALER COMPLETE REPAIR LAB ON PREMISES

"Aquí Se Habla Español"

BARRY INTERNATIONAL TELEX 12-7670
MERCHANDISE TAKEN ON CONSIGNMENT
FOR TOP PRICES

Monday-Friday 9 A.M. to 6:30 P.M. Thursday to 8 P.M.
Saturday & Sunday 10 A.M. to 5 P.M. (Free Parking)

IRT/LEX-"Spring St. Station", Subways: BMT-
"Prince St. Station", IND-"F" Train-Bwy Station"
Bus: Broadway #6 to Spring St. Path-9th St./6th Ave.
Station.

COMMERCIAL RADIOS
STOCKED: ICOM, Motoro-
la, MAXON, Standard,
Yaesu. We serve municipa-
lities, businesses, Civil
Defense, etc. Portables,
mobiles, bases, re-
peaters...

ALL
SALES
FINAL

We Stock: AEA, ARRL, Alinco, Ameco, Ameritron, Antenna Specialists,
Astac, Astron, B&K, B&W, Bencher, Bird, Butternut, CDE, CES, Cushcraft,
Daiwa, Eimac, Henry, Heil, Hustler, Hy-Gain, Icom, KLM, Kantronics, Larsen,
MJF, J.W. Miller, Mirage, Nye, Palomar, RF Products, Saxton, Shure,
Tempo, Ten-Tec, TUBES, Yaesu, Vibroplex, Duplexers, Repeaters, Scan-
ners, Radio Publications, Uniden, Kenwood, Maxon, RFC.

WE NOW STOCK COMMERCIAL COMMUNICATIONS SYSTEMS
HAM DEALER INQUIRES INVITED PHONE IN YOUR ORDER & BE REIMBURSED

COMMERCIAL RADIOS stocked & serviced on premises.
Amateur Radio Courses Given On Our Premises, Call
Export Orders Shipped Immediately. TELEX 12-7670

FAX: 212-925-7001

Elmer's Notebook

Tom McMullen, W1SL

VISUAL AIDS — LIQUID CRYSTAL DISPLAYS

In this last article in my series on visual aids, I'll look at a type of display used in a multitude of products — including watches, volt/ohm/milliammeters, computer screens, automotive monitoring systems, and transceivers. (The list is far too long to complete here.) It's called a liquid crystal display, or LCD. The beauty of this type of display is that it can be manufactured to show characters in any language, or to provide a visual symbol in any shape. It also uses very little power.

What's in it?

The principle used in the LCD comes from a laboratory device for exploring methods of electronically controlling light transmission. This experimental device is called a Kerr cell (see Figures 1A and 1B). It works as a result of polarization. The input and output sides of the Kerr cell have a polarized coating which allows light with the same polarization as the coating to pass through it. When the liquid in the cell is polarized the same as the coating material, the light passes through. When voltage is applied to the electrodes, the liquid changes its polarization, and the light doesn't pass through (refer to Figure 1B).

You can perform an experiment with polarized light using the lenses from a pair of sunglasses that have a polarized coating — plain tinted lenses won't work. Look at a light through both lenses, and rotate one lens as you do so. At some point, the light will decrease markedly or perhaps disappear. This is the point at which the lenses are polarized 90 degrees apart. A polarizing filter for photographic use works in a similar manner; glare and reflections are polarized to some extent, and when the filter is rotated, the glare can be reduced for improved photographs.



can be small enough to use in a wrist watch, or large enough to display many lines of text or graphics on a laptop computer.

A basic LCD element is shown in Figure 2. It consists of two pieces of glass with a liquid sandwiched between. The inner surface of each piece of glass is coated with a very thin metallic layer which serves as an electrical contact, and will allow light to pass. In its normal, unexcited state the liquid isn't polarized (see Figure 2A).

Putting theory to work

The Kerr cell is a bulky apparatus; it's most useful in laboratory and other experimental uses. The modern LCD is an adaptation of this principle that

FIGURE 1

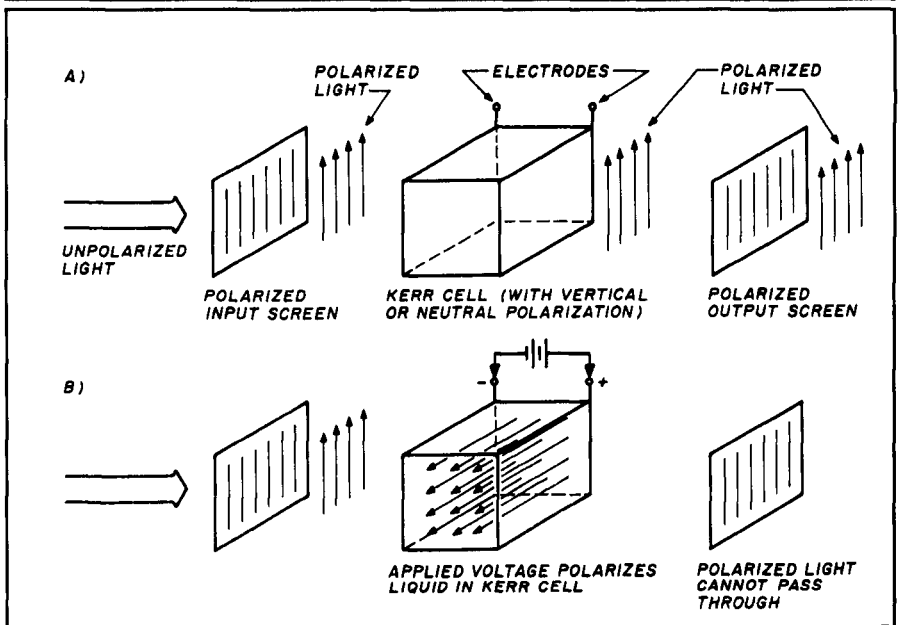

The predecessor for today's LCD was the Kerr Cell shown here in a simplified view. A liquid in the cell could be polarized by applying a voltage. When the polarization of the crystal-line structure in the liquid was different from the light entering the cell, output was decreased.

FIGURE 2

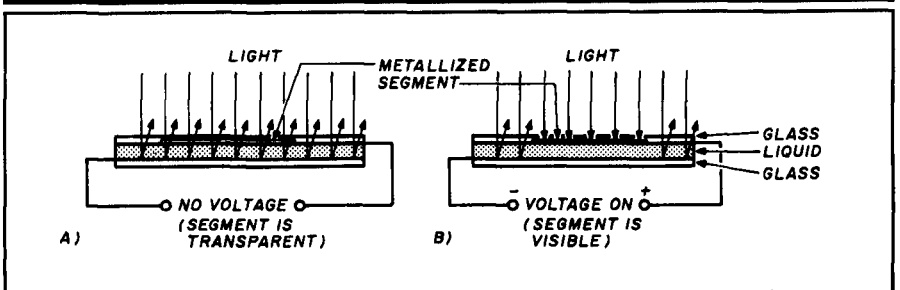

The LCD used on most devices today is a sandwich of glass with a liquid crystal material between. The glass has thin metallic layers for electrical contact.

FIGURE 3

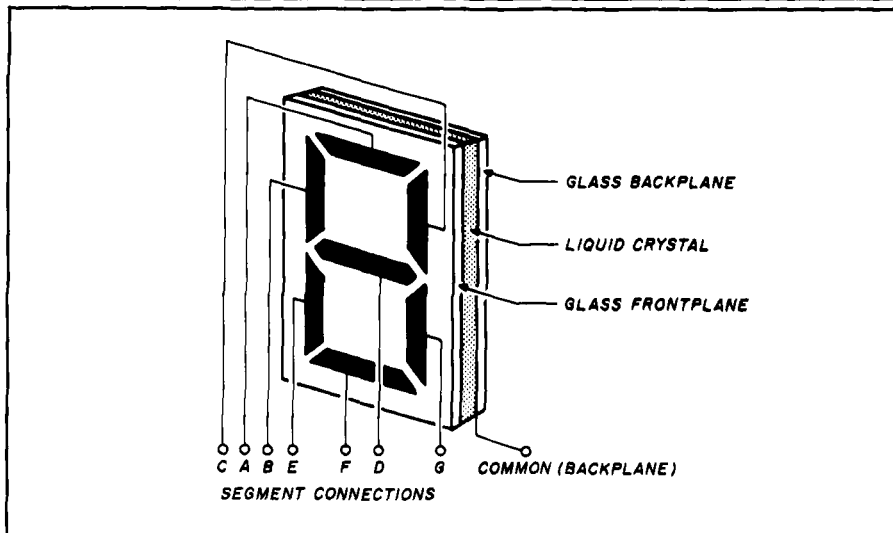

A common seven-segment readout element as used in many numeric applications today. A simple, inexpensive driver IC activates the proper segments to form numbers.

When voltage is applied to the metallic layer, the crystalline structure in the liquid changes direction (polarization) and stops the light. Most LCDs depend upon reflected light; when you view the display from the front, you see the outline of whatever shape the metallic segment has as a silhouette against the reflective backplane **Figure 2B**.

In its simplest form (in clocks, watches, calculators, and other strictly numeric readout devices) each segment of a number is a conducting transparent layer connected to a contact — much the same as the LED seven-segment display I described last month. **Figure 3** shows a seven-segment LCD readout display. A simple decoder IC can drive the desired segments to form a number. Some LCDs have a large number of segments and can form letters as well as numbers, in what's called an alphanumeric display.

Complex characters

Even greater versatility is obtained by forming the characters with an array of dots that can be turned on or off individually. This type of readout is called a dot-matrix LCD. The dot pattern is often five or six dots wide and seven or eight dots high, but there are many other possibilities. **Figure 4** shows an example of a 5 × 7 matrix.

This type of display requires a more sophisticated driver. It operates by decoding the incoming data and deciding which rows or columns to

energize for the pattern required. **Figure 5** shows the letter N. It's formed by first activating all the rows (0 through 6) along with column 0. The driver then activates row 4 and column 1, row 3 and column 2, row 2 and column 3, and finally rows 0 through 6 and column 4. The polarity of the liquid (actually, in many devices it's almost a jelly) behind each dot changes, shutting off the reflected light. What you see is the dark letter against a light background.

What keeps the first vertical column of the N from disappearing while the driver is working on the rest of the letter? Once you have "turned on" polarized liquid, it stays that way until another voltage application turns it off. This is where the low power consumption advantage comes in. You don't need to keep voltage on the segment all the time — just refresh it once in a while with another pulse of voltage to keep it from fading away. Without refreshing, LCDs fade after a while; some inexpensive ones disappear in a few minutes, but better ones last much longer. They change gradually from black, to grey, to clear.

Of course, the more dots you have the more metallic contacts you need, and the more complex the driver circuitry must be. Modern microprocessors and driver ICs can handle this with ease. Multiple digit readouts use a technique called "strobing." The driver turns on the correct dots or segments in the first character, then goes to the next one and activates it, and so

FIGURE 4

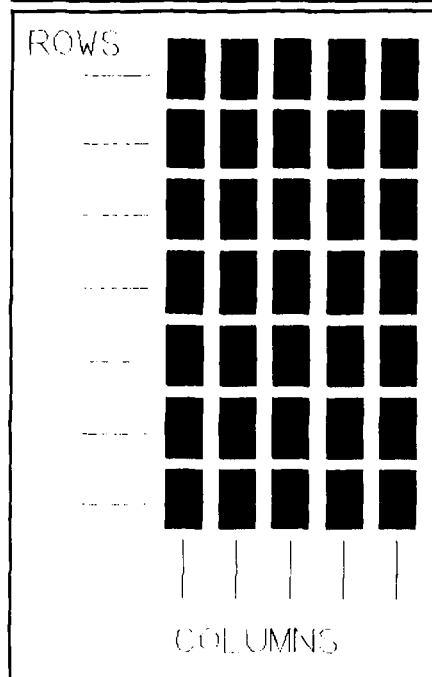

An array of dots forms a matrix for complex characters. This array is five dots wide by seven dots high; many other combinations are possible.

on, until all characters are active.

If there are multiple lines (as there are on a computer screen), the driver can work on one line after the other. It moves down the screen so fast that

FIGURE 5

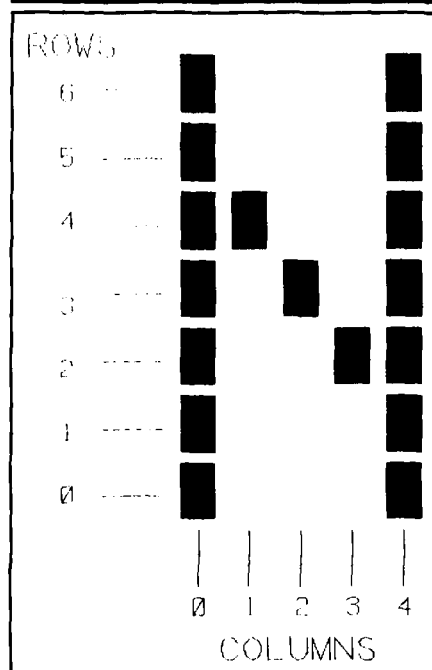

The letter "N" formed by activating the correct rows and columns of a dot-matrix display. See text.

your eye doesn't see any flicker, then returns to the top to either refresh the first line of characters or to make changes in it.

Of course all these metaled spots, rows, and columns require connections to the outside world so the driver circuits can apply voltage. There are a large number of connections at the edge of the glass readout device, and these are somewhat fragile. However, most LCD assemblies are packaged in such a way that you can't damage them if you take reasonable care. Flexible ribbon cable is often used to make connections between the LCD and the rest of the circuits. LCDs do have the slight disadvantage of being temperature sensitive. People traveling in cold climates are accustomed to seeing the wrong time on their automotive clocks until the heater has warmed the passenger compartment, and the liquid in the LCD has thawed enough to respond to voltage pulses. The electronics for the clock continue to work normally, so when the LCD thaws out it suddenly shows the correct time. Latest advances in LCD technology have produced displays in many colors; you'll see them in some of the newer Amateur transceivers, and some computer screens. An item that caught my eye just recently was a book-sized AM/FM/TV receiver with a flip-up screen. The screen was an LCD approximately 4 x 5 inches, showing a color TV program in amazing clarity. What an improvement compared to the first color TV set I saw. It took two people to move, and used three cathode-ray tubes and filters to produce a color image. The modern LCD version fits in a briefcase and has a better picture too!

Coming in my next column — what you can do with simple, inexpensive instrumentation. **174**

Quick Interconnect  **POWERPOLE**

• Fool-Proof • Fast • Genderless • Color coded • 30A Silver • Reliable • Switch from mobile to shack in seconds. Interchange power supplies and rigs in moments. Interconnect battery, charger, controller, solar panel, generator, backup / conventional power instantly in any combination. Create custom multi-pole connectors in seconds w/ lego-like stacking. Easy crimp/solder, assembly. No special tools required.

Sold in Sets of 2
Red-Black pairs **10 \$ 19.95** sets
20 \$ 36.95 sets Add \$3 PAH Info Sample \$2

Antennas West Box 50062, Provo, UT 84605 **801-373-8425**

Now receive or leave messages with other local hams using the 16K Bulletin Board featured on the smallest TNC available—the Heath® HK-21 Pocket Packet.

The BBS operates under your call with simple commands like **Send** or **Write** a message, **Kill** a message and read the **File** messages currently on the system. And the HK-21 Pocket Packet is fully TNC-2 compatible.

Hookup is easy. Plug in supplied cables instantly to most

HT's, or wire a separate cable into your mobile or base VHF or UHF rig. Connect your

computer via RS-232 and you're ready to call a fast-growing number of packet hams.

The HK-21 Pocket Packet requires only a single 12 VDC @ 40mA power source or as little as 29mA from an optional HKA-21-1, internally mounted 4.8 volt, 120 mAh, NICAD battery.

The Heath® HK-21 Pocket Packet — **\$219.95** (Amateur net price)
To order, call 1-800-253-0570

For information on Heath's complete line of amateur radio products call 1-800-44-HEATH for your FREE Heathkit® catalog.

Best to start with.
Best to stay with.

Heath Company
Benton Harbor, MI 49022

Get your message across... even when no one is listening.



A subsidiary of Zenith Electronics Corporation. ©1989, Heath Company

INTRODUCING...

Special Introductory Offer
Just **\$19.95** Per Library
(Reg. Retail Value \$24.95)
PLUS FREE BONUS (See Details)

THE NEW AZIMUTH AWARDS QSL LIBRARY

New Handsome Custom Albums To Collect, Protect & Organize Your Hard-Earned QSL Cards... Plus Special Albums for DXCC, WAS/WAC, & WAZ Radio Awards

Throw out the shoe boxes. Get your QSLs organized with the new Azimuth Awards QSL Library. The perfect way to display the cards for your prestigious awards—for easy viewing. Each padded vinyl album comes complete with 20 heavy duty crystal-clear, slip-in pocketed vinyl pages (each holds 6 cards).

Now available for the most prestigious awards in amateur radio... order all and organize your cards for each award • DX Century Club • Worked All Zones • Worked All States & Continents • a general QSL Album for any purpose! Looks great in your shack! Need more pages? Order extra pages (20/page). Satisfaction Guaranteed! If not completely delighted return your purchase in 10 days for a money-back refund.

Call or Send For Your Azimuth QSL Award Library Today!

SEND TO: Azimuth Awards Library, Dept. Q1
11845 W. Olympic Bl., Suite 1100, Los Angeles, CA 90064
1-213-473-1332 for information

FREE BONUS WITH TWO OR MORE ALBUMS!

Get The New Azimuth AwardsBase Tracking Software for the IBM-PC (\$24.95 value) **Free!** Exclusive new program helps you stay on top of contacts by band, cards sent and received and much, much more to monitor your radio award progress.

Azimuth QSL Awards Library—Each just \$19.95 plus \$2.50 shipping & handling.
Specify: 1) DXCC 2) WAZ 3) WAS/WAC 4) Standard Album
Extra 20 Page Packs Just \$12.95 (\$2.50 S&H)
Enclose check or money order. (Cal. Res. add 6.5% tax.)
VISA or MasterCard. (Foreign orders triple S&H)

Credit Card Orders Call Today Toll Free
Nationwide 1-800-882-7388

(9AM to 6PM PST) Made in USA
Allow 4 to 6 Weeks Delivery
© MCLMXXXIX Azimuth Communications Corporation

PRODUCT REVIEW

Morse Code Tutor Program

"Morse: The Code Machine" by Laresco, a morse code tutor for Apple II series and C-64 computers, is designed to teach code recognition and build speed. It can be used by someone preparing for the Novice exam, anyone who wants to upgrade, or by the ham who simply wants to increase code speed. There are 12 different software packages available, from the basic Fundamental to the "all frills" Elite+. Each successive version of the program includes more modes and features. Purchasing a code oscillator lets you take advantage of the manual's code sending lessons.

The Fundamental package is a "bare bones" version of the program. It generates code sounds for characters in text memory. No characters are displayed on the screen. You practice writing the characters on paper for the code you hear. After completing the session, you can view the text in memory and compare it with what you wrote.

I worked with the Elite+ version. It has three learning modes: teach, drill, and practice. Each mode is broken down into sections which let you tailor your learning experience and concentrate on your weakest areas. The manual suggests you use all three modes in two daily sessions for the best possible code workout.

Teach mode concentrates on basic Morse code recognition. You can use any one of five different teaching modes. Each concentrates on getting you to connect the letter with its particular code sounds. Code can be self- or machine generated.

In *drill mode*, you work to increase your recognition of what you've learned in *teach mode*. Characters or code sounds are generated by the computer and stored in a buffer. You have the option of matching the character with the code, or the code with the character, by hitting the appropriate key on the keyboard. The computer corrects you when you make a mistake.

After you've worked with the teach and drill modes, you can improve your code recognition speed with *practice mode*. This mode allows you to practice what you've learned using self- or computer-generated text.

Depending on which package you purchase, text can be typed in or loaded from a DOS 3.3 disk file. You also have the option of saving text memory to disk or viewing text memory on the screen. All packages allow you to choose extended sound spacing (i.e., spacing between dots and dashes within a character) and transmission tone frequency; the "+" packages also have extended character and word spacing capabilities. The more complex packages

include color graphics, but you don't need a color monitor to use the graphics modes. The Fundamental and Fundamental + versions come with an 18-page abbreviated manual. All other packages come with a 33-page detailed manual which describes all the modes and features, and includes basic lesson plans. For more information on the different packages and their capabilities contact: Laresco, POB 2018 1200 Ring Road, Calumet City, Illinois, 60409. Phone: (312)891-3279.

It took me a few hours of playing around with the program and its various options to realize all it could do for me. I'm not very "computer literate" so there were a few things that I had to learn by trial and error. My biggest mistake was in not taking the time to sit down and read the manual thoroughly.

On the whole, however, I think the "Code Machine" is a useful tool for learning the code. Depending on the package you choose, you have several different ways to learn. But you don't have to take my word for it! My eight-year-old son dropped by my office while I was playing with the program. Within 15 minutes of using "Morse: The Code Machine," he recognized many more letters than he had when he started...and it took some persuading so I could get in on the fun too!

de KA1STC

NEW PRODUCTS

Packet Talker

Engineering Consulting announces the "Packet Talker" model PKTA for the Commodore 64 and compatible computers. The PKTA uses software to convert ASCII messages into speech. Messages can be stored in bulletin board format for up to 300 users; they can be retrieved by preassigned touchtone access commands. Each message is spoken over the air from the computer's voice synthesizer. Use the Packet Talker with repeater controllers to add a talking packet bulletin board, or hear messages from a personal mobile packet terminal.

The PKTA can link a packet TNC with any voice repeater. Hardware and software are provided for interfacing to the C-64. Audio from the TNC and PTT circuits of the transceiver combine with the computer's voice allowing conventional packet communications and voice retrieval of messages on request.

A similar option (PK8 and PK1) is available for Ultra ComShack 64 repeater controllers. When used with the Ultra, the Packet Talker allows complete repeater control, remote screen transfer of

all active parameters, voice messages, and remote programming of all parameters from any off-site TNC terminal.

The model PKTA Packet Talker sells for \$189.95 and is available from Engineering Consulting, 583 Candlewood Street, Brea, California 92621. Phone: (714)671-2009 or FAX (714)255-9984.

New Field Calibration Power Sensor

Bird Electronic Corporation has announced the model 4029 Power Sensor Calibrator for use with their 4420 series RF power meters. With a CRT terminal or a PC with a serial port, the 4029 provides in-field calibration of 4420 power meters to within ± 3 percent of a known RF standard.

The 4029 supplies a menu-driven protocol to the terminal to aid in the calibration process. You drive a 4020 series RF power sensor connected to the calibrator with a known amount of RF power at a specific frequency, and enter the

power level into the terminal keyboard. The calibrator calculates and stores a correction factor in the power sensor's memory for that frequency.

Bird also has the model 4024 Directional Power Sensor, the latest addition to the 4020 series of Thruline® design RF sensors. The frequency range of the unit is 1.5 to 32 MHz at up to 10 kW. Other sensors in the series cover ranges from 1.8 to 32 MHz and 25 to 1000 MHz at up to 1 kW. All 4020 models are unconditionally guaranteed for life.

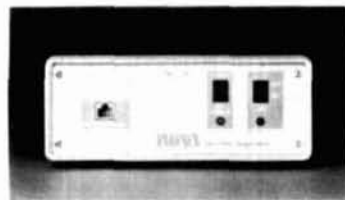

COMPUTER SOFTWARE

LOW BAND DX-ING COMPUTER PROGRAMS

by John Devoldere, ON4UN - 3D programs for Apple II, MS-DOS, Commodore C-128 and Kaypro CPM Computers

Just about every interest or need is covered—from antenna design and optimization to general operating programs. Antenna programs include: shunt and series input L network design, feedline transformer, shunt network design, SWR calculation, plus 11 more! General Ham programs include: sunrise/sunset, great circle distances, grayline, vertical antenna design program, sunrise calendar plus 9 more! © 1986.

- UN-Apple II \$39.95
- UN-MS (MS-DOS) \$39.95
- UN-CPM/Kaypro \$39.95
- UN-C-128 (COMMODORE C128) \$39.95
- UN-MAC (MACINTOSH) \$49.95

SKYCOM 1.0 software for MS-DOS & MAC

by Paul Schmid, W4HET
Worldwide HF predictions from your city or town using the latest in propagation technology. Tells you when and on what frequency to tune your radio to work DX. Also takes into account total path loss for maximum usefulness. Available in both Macintosh and MS-DOS formats.

- ES-MS (MS-DOS) \$49.95
- ES-MAC (MACINTOSH) \$49.95

DX WINDOW for MAC

by Paul Schmidt, W4HET
Use your Macintosh to determine grayline openings for stations around the world. Automatically calculates sunrise or sunset times for over 400 locations on the globe. Invaluable aid for lowband DX'ers. Requires Mac 512 or later.

- ES-DX (MACINTOSH) \$59.95



By
Chip Lohman
NN4U FOR C-64
AMATEUR RADIO COMPUTER SOFTWARE

MASTER LOG New Version

Master Log creates a file of 2100 individual records with up to 13 different entries per record. It can do a search and select based upon time, frequency, mode and keeps track of DXCC and WAS status, prints QSL labels and can search its whole file in less than 5 seconds! Complete documentation is included to help you learn and use this truly state-of-the-art logging program. ©1988.

- HD-ML (For C-64) \$28.95

SUPER LOG

Super Log gives you all the advantages of a computerized data base without significantly changing the traditional log format. Super Log also allows you to print out either selected contents or the whole log. Will print QSLs.

- HD-PC (For C-64) \$19.95

CONTEST LOG

This disk contains four different contest programs; ARRL Sweepstakes, Field Day, Universal WW Contest log, plus a dupe checking routine. Automatically enters date, time, band and serial number for each contact. When the contest is over, the program will print your results listing all duped and scored contacts in serial sequence with all the necessary information as well as completed score at the bottom of the page.

- HD-CL (For C-64) \$24.95

RF-CAD ELECTRONICS DESIGN PROGRAM — Version 3.7 Includes Intermodulation and Distortion Program

by Joe Reiser, W1JR and Gary Field, WA1GRC
For IBM PC and compatible computers
This software package has been written by electronic engineers and contains nearly 40 tested and proven programs. Emphasis has been placed upon ease of use. Programs include: Filters, LC, active-LP, HP, BP; Inductor design, torroid, solenoid, straight wire; Matching networks; Crystal oscillators; Microstrip; Transmission lines; Antennas, Yagi-Uda, helix, dish, horn, element scaling; Pi and T attenuators. Also included: Radio Path calculations; FM modulation analysis, Miscellaneous conversions; Geostationary satellite pointing; Moon tracking aids; Receiver noise figure calculations and Spurious receiver response prediction. Requires IBM-PC with at least one floppy drive and 128k of RAM. © 1985

- RF-CAD (MS-DOS) \$39.95

DX EDGE MS-DOS AND C-64 software

Particularly helpful in determining long path and grey line openings. Super fast speed and dazzling graphics make this program a treat to use. The MS-DOS version also includes a close up (zoom) feature for detailed examination, a MUF calculator and a great circle bearing routine. All call sign prefixes and country names are built into the data base for easy pinpointing of locations. MS-DOS version also color compatible. Requires 2 disk drives, 348k of memory, Hercules, CGA or EGA graphics and DOS 2.1 or later.

- XN-DOS (IBM or compatible computers) \$34.95
- XN-C64 (C-64 computer) \$34.95
- XN-DX (slide rule version) \$22.95

Please enclose \$3.75 shipping & handling



HAM RADIO'S BOOKSTORE

Greenville, NH 03048 • (603) 878-1441

NUTS & VOLTS

MAGAZINE

P.O. Box 1111-H
PLACENTIA, CA 92670
714-632-7721



- Ham Radio
- Computer Hardware
- Computer Software
- Plans-Kits
- Schematics
- Test Equipment
- CB Gear
- Satellite TV
- Video
- Components
- Antique Electronics
- Cable TV
- Publications
- Repairs-Services
- New Products
- Events Calendar

IF YOU ARE INTO ELECTRONICS AND SAVING MONEY IS IMPORTANT TO YOU, THEN YOU OWE IT TO YOURSELF TO TRY NUTS & VOLTS MAGAZINE. DISCOVER WHY THOUSANDS OF SMART PEOPLE NATIONWIDE TURN TO NUTS & VOLTS EACH MONTH TO MEET THEIR ELECTRONIC NEEDS. WHETHER YOU'RE BUYING, SELLING, OR JUST TRYING TO LOCATE THOSE UNIQUE OR HARD-TO-FIND ITEMS, FIND OUT HOW NUTS & VOLTS CAN HELP!

SUBSCRIBE TODAY!

CHECK MONEY ORDER VISA MC

Name _____

Address _____

City _____

State _____ Zip _____

Card No. _____ Exp. Date _____

CALL FOR ADVERTISING INFORMATION
DISTRIBUTOR INQUIRIES INVITED

Subscription Rates

U.S. FUNDS REQUIRED

3rd Class Mail - USA

One Year \$12.00
Two Years \$21.00
Lifetime \$60.00

1st Class Mail

One Year - USA . . . \$20.00
Canada & Mexico . . \$22.00

Air Mail

Foreign - 1 Year . . . \$55.00

Includes one FREE 40-word
Classified Ad

NEW PRODUCTS

For further information contact Bird Electronic Corporation, 30303 Aurora Road, Cleveland (Solon), Ohio 44139. Phone: (216)248-1200.

Circle #301 on Reader Service Card.

AVCOM's PSA-65A Portable Spectrum Analyzer

AVCOM introduces its portable spectrum analyzer, model PSA-65A. It covers frequencies through 1000 MHz in one sweep with a sensitivity greater than -90 dBm at narrow spans. The lightweight battery or line-operated spectrum analyzer is for two-way radio, cellular, cable, and other uses. Options include frequency extenders to enable the PSA-65A to be used at Satcom and higher frequencies, audio demod for monitoring, log periodic antennas, and carrying case. For brochure and spec sheet contact AVCOM of VA, Inc., 500 Southlake Boulevard, Richmond, Virginia 23236. Phone: (804)794-2500, FAX (804)794-8284, or TLX 70-1545 AVCOM.UD.

Circle #302 on Reader Service Card.

Antenna Specialists Company Catalog

The Antenna Specialists Company has released a new Amateur Radio products catalog, no. HM-1001. It lists over 30 models of mobile antennas, base antennas, power dividers, and RF power amplifiers. Included are the patented DURA-FLEX® neoprene elastomer shock spring models, and On-Glass® window mount mobile antennas. A copy of the catalog is available from The Antenna Specialists Company, 30500 Bruce Industrial Parkway, Cleveland, Ohio 44139-3996. Phone: (216)349-8400 or FAX (216)349-8407.

Circle #303 on Reader Service Card.

Phillips Drivers Tooled for Foreign Electronics

Jensen Tools offers a set of six Phillips screwdrivers tooled for Japanese, European, and other foreign equipment. These Telvac drivers are made of hardened steel with standard grip, acid-resistant plastic handles. The set, priced at \$12.95, is featured in Jensen's free 1989/90 catalog.

For more information write or call Jensen Tools, Inc., 7815 S. 46th Street, Phoenix, Arizona 85044. Phone: (602)968-6231.

Circle #304 on Reader Service Card.

When performance & price really count...



CRYSTEK CRYSTALS

The pulse of dependable communications

QUARTZ CRYSTALS FOR
Industrial Equipment/Instrumentation

- Micro-processor control
- Computers/Modems
- Test/Measurement
- Medical

General Communications

- Channel element Service (VHF/UHF)
- Land Mobile 2-way
- Marine
- Aircraft
- Telemetry
- Monitors/Scanners/Pagers

Amateurs/2-Meter/General Coverage CB/Hobbyist/Experimenter

The Pulse of Dependable Communications...

Crystek Crystals offers their new 16 page FREE catalog of crystals and oscillators. Offering state of the art crystal components manufactured by the latest automated technology. Custom designed or "off the shelf," Crystek meets the need, worldwide. Write or call today!

For Optimum Stability and Reliability in Frequency Management

Custom Made Crystals Catalog

NEW



Replacement Crystals Catalog

CRYSTEK CORPORATION
DIVISION OF WHITEHALL CORPORATION

2351/2371 Crystal Drive • Ft. Myers, FL 33907
P.O. Box 06135 • Ft. Myers, FL 33906-6135
TOLL FREE 1-800-237-3061
PH 813-936-2109/TWX 510-951-7448/FAX 813-939-4226
TOLL FREE IN THE U.S.A. EXCEPT FLORIDA, ALASKA, HAWAII



179

ANTENNA ANALYSIS

The new MN program will analyze almost any antenna made of wire or tubing. Compute forward gain, F/B, beamwidth, sidelobes, current, impedance, SWR, near-fields, and far-fields, in free space or over realistically-modeled earth. Plot antenna radiation patterns on your graphics screen. MN can compute the interaction among several nearby antennas. The 5-1/4" MN disk contains over 100 files, including libraries of antenna and plot files, a file editor, and extensive documentation. MN is an enhanced, easy-to-use version of MININEC for IBM-PC. \$75 (\$80 CA & foreign).

YAGI OPTIMIZER

The remarkable new YO program automatically adjusts Yagi element lengths and spacings to maximize forward gain, optimize pattern, and minimize SWR. Radiation patterns at band center and edges are updated on your screen during optimization. YO is extremely fast, computing several trial Yagi designs per second with 8087. YO is a complete Yagi design package for IBM-PC, containing models for gamma and hairpin matches, element tapering, mounting plates, and frequency scaling. A library of Yagi files and extensive documentation are included. \$90 (\$95 CA & foreign).

To order, send a check to:

Brian Beezley, K6ST1, 507-1/2 Taylor, Vista, CA 92084

SMART REPEATER & LINK CONTROLLER

- DTMF MUTING
- INTELLIGENT ID'ER
- AUXILIARY OUTPUTS
- EASY TO INTERFACE
- REPEATER & LINK COURTESY TONES
- LOW POWER, 22ma @ 12V
- TELEMETRY RESPONSE TONES
- ALARM MONITOR INPUT
- SYNTHESIZED LINK/REMOTE BASE CAPABILITY WITH OPTIONAL PI-10/S SYNTHESIZER BOARD

SRC-10 — \$149.00/PI-10/S — \$39.00

REPEATER/LINK AUDIO MIXER INTERFACE

- FIVE AUDIO INPUTS
- THREE ADJUSTABLE AUDIO OUTPUTS
- CTCSS DECODER ON UAI-20 ONLY
- CONTROLLED DTMF ROUTING
- LOW POWER, 19ma @ 12V
- EASY TO INTERFACE
- LINK MONITOR-MIX/MONITOR MUTE CONTROL

UAI-10 — \$44.00/UAI-20 — \$89.00

ASSEMBLED & TESTED
ONE YEAR WARRANTY

CREATIVE CONTROL PRODUCTS

3185 Bunting Avenue
Grand Junction, CO 81504
(303) 434-9405



181

THE MOST AFFORDABLE REPEATER

ALSO HAS THE MOST IMPRESSIVE PERFORMANCE FEATURES
(AND GIVES THEM TO YOU AS STANDARD EQUIPMENT!)

KIT, ONLY \$675
WIRED \$975
VHF OR UHF



FEATURES:

- **SENSITIVITY SECOND TO NONE!** GaAsFET front end on vhf models gives 12dB SINAD of 0.12uV (vhf), 0.15uV (220). UHF model 0.25uV std, 0.1uV with optional helical resonator preamp.
- **SELECTIVITY THAT CAN'T BE BEAT!** Both 8-pole xtal filter & ceramic filter for > 100dB at only ±12kHz. Helical resonator front end to combat desense & intermod.
- **CLEAN, STABLE TRANSMITTER**, up to 18W output standard; 50W with accessory power amplifier.
- **FCC TYPE ACCEPTED** for commercial high band and uhf.
- **Courtesy beep**, field-programmable CWID, flutter-proof squelch, automatic frequency control to compensate for off-frequency transmitters (all standard features).
- **Full range of options** available, such as autopatch, phone line or radio remote control, sub-audible tones, duplexers.

HIGH PERFORMANCE TRANSMITTERS & RECEIVERS FOR REPEATERS AUDIO & DIGITAL LINKS, TELEMETRY, ETC.

FM EXCITERS:

- Kits \$99, w/t \$179. 2W continuous duty. TCXO & xtal oven options available.
- **TA51 for 10M, 6M, 2M, 150-174, 220 MHz.**
- **TA451 for uhf.**

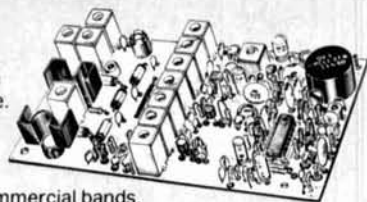

- FCC type accepted for commercial bands.
- Call for latest information on 900 MHz transmitters.
- **VHF & UHF AMPLIFIERS.** For FM, SSB, ATV. Output from 10 to 50 Watts. Several models, kits starting at \$79.

- **R144/R220 FM RECEIVERS** for 2M, 150-174, or 220 MHz. GaAs FET front end, 0.12uV sensitivity! Both crystal & ceramic filters plus helical resonator front end for exceptional selectivity: > 100dB at ±12kHz (best available anywhere)! Flutter-proof squelch. AFC tracks drifting transmitters. Kit \$149, w/t \$229.

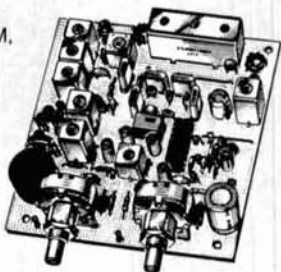

- **R451 UHF FM RCVR.** Similar to above. Tuned line front end, 0.25uV sens. (0.1uV with optional hel. res. preamp). Kit \$149, w/t \$229.
- **R901 FM RCVR FOR 900 MHZ.** Triple-conversion, GaAs FET front end, 0.2uV sens. Kit \$169, w/t \$259.
- **R76 ECONOMY VHF FM RCVR** for 10M, 6M, 2M, 220. Without hel res or afc. Kits only \$129.
- **Weather satellite & AM Aircraft receivers also avail.**

FCC TYPE-ACCEPTED TRANSMITTERS & RECEIVERS AVAILABLE FOR HIGH-BAND AND UHF. CALL FOR DETAILS.

- Send \$1 for 36 page catalog by return mail. (Send \$2.00 or 4 IRC's for overseas mailing)
- Order by phone or mail • Min \$3 S & H per order
- Use Visa, Mastercard, Check, or UPS COD.

GaAs FET PREAMPS at a fraction of the cost of comparable units!

LNG-(*)

GaAs FET PREAMP



ONLY \$59!
Wired/tested

FEATURES:

- **Very Low Noise:** 0.7dB VHF, 0.8dB UHF
- **High Gain:** 13-20dB, depending on frequency
- **Wide Dynamic Range:** to resist overload
- **Stable:** new-type dual-gate GaAs FET

* Specify tuning range desired: 26-30, 46-56, 137-150, 150-172, 210-230, 400-470, or 800-960 MHz.

LNW-(*)

MINIATURE GaAs FET PREAMP



ONLY \$24/kit,
\$39 Wired/tested

GaAs FET Preamp similar to LNG, except designed for low cost & small size. Only 5/8"W x 1-5/8"L x 3/4"H. Easily mounts in many radios.

* Specify tuning range desired: 25-35, 35-55, 55-90, 90-120, 120-150, 150-200, 200-270, or 400-500 MHz.

LNS-(*)

IN-LINE PREAMP



ONLY \$79/kit,
\$99 Wired/tested

GaAs FET Preamp with features similar to LNG series, except automatically switches out of line during transmit. Use with base or mobile transceivers up to 25W.

* Specify tuning range desired: 120-175, 200-240, or 400-500 MHz.

HELICAL RESONATOR PREAMPS

Low-noise preamps with helical resonators reduce intermod & cross-band interference in critical applications.

MODEL HRA-(*) , \$49 vhf, \$84 uhf.

* Specify tuning range desired: 142-150, 150-162, 162-174, 213-233, 410-454, or 454-475.

ACCESSORIES



COR-3 REPEATER CONTROL-ER kit. Features adjustable tail & time-out timers, solid-state relay, courtesy beep, and local speaker amplifier.\$49

CWID kit. Diode programmed, adjustable tone, speed, and timer, to go with COR-3.\$59

NEW COR-4 kit. Complete COR and CWID all on one board for easy construction. CMOS logic for low power consumption. Many new features. EPROM programmed; specify call letters.\$99

NEW TD-3 SUBAUDIBLE TONE DECODER/ENCODER kit.\$24

TD-2 DTMF DECODER/CONTROLLER kit. Full 16 digits, with toll-call restrictor, programmable. Can turn 5 functions on/off. Great for selective calling, too!\$79

AP-3 AUTOPATCH kit. Use with above for repeater autopatch. Reverse patch and phone line remote control are std.\$79

AP-2 SIMPLEX AUTOPATCH Timing Board kit. Use with above for simplex operation.\$39

MO-202 FSK DATA MODULATOR kit. Run up to 1200 baud digital signals through any fm transmitter with full handshakes. Radio link computers, telemetry gear, etc.\$39

DE-202 FSK DEMODULATOR kit. For receive end of link.\$39

9600 BAUD DIGITAL RF LINKS. Low-cost packet networking system, consisting of new MO-96 Modem and special versions of our 220 or 450 MHz FM Transmitters and Receivers. Interface directly with most TNC's. Fast, diode-switched PA's output 15 or 50W. Call for info on the right system for your application!

RECEIVING CONVERTERS



	Antenna Input Range	Receiver Output
	28-32	144-148
	50-52	28-30
	50-54	144-148
VHF MODELS	136-138	28-30
	144-146	28-30
	145-147	28-30
	146-148	28-30
Kit with Case	\$59	220-222 28-30
Kit less Case	\$39	220-224 50-54
Wired w/case	\$89	222-224 28-30
UHF MODELS	432-434	28-30
	435-437	28-30
	432-436	144-148
Kit with Case	\$69	432-436 50-54
Kit less Case	\$49	439-25 61-25
Wired w/case	\$99	902-928 422-448
		902-922 430-450

See catalog for full line of 2w transmitting converters for vhf & uhf. Kits only \$79. Linear Amplifiers avail. up to 50 w.

Our 26th Year

hamtronics, inc.

65-H MOUL ROAD • HILTON NY 14468-9535

Phone: 716-392-9430 Hamtronics® is a registered trademark

New Products

MFJ Offers Code Practice Oscillator

MFJ Enterprises, Inc., announces its new MFJ-557 deluxe code practice oscillator for \$24.95. It features a straight Morse key and a code oscillator with a built-in speaker, mounted together on a non-skid heavy steel base. A volume control lets you adjust it from barely audible to full sound. A tone control gives you a wide tone adjustment. An earphone jack is included.

The oscillator runs on a 9-volt battery (not included) or 110 volts AC with an optional power supply (\$9.95) that plugs into a jack on the side of the MFJ-557. The straight key features screw-adjustable contacts and can be hooked to your transmitter and used for sending code over the air. The measures 8-1/2 x 2-1/4 x 3-3/4 inches. It comes with MFJ's one-year unconditional guarantee.



For more information contact MFJ Enterprises, Inc., PO Box 494, Mississippi State, Mississippi 39762. Phone: (601)323-5869. To order, call toll free (800)647-1800.

Circle #305 on Reader Service Card.

New Software Logging Program

"Hamlog" is a new modular auto-logging software program by Ernest Sandoe, KA1AWH.

This stand-alone user friendly program has over 17 modules and can be supplied to run in Turbo BASIC or MS/PC BASIC for IBM compatibles. It works well on 64K.

"Hamlog" is also available for over 130 different computers using the CP/M operating system, and for Apple computers using Apple BASIC.

An optional QSL label writing program is available for \$5 plus \$2 shipping and handling.

Send \$24.95 (\$19.95 for Apple version) to Ernest Sandoe, KA1AWH, POB 2015, Peabody, Massachusetts 01960. (Massachusetts residents include 5-percent sales tax.)

Circle #306 on Reader Service Card.

Alpha Delta Model DELTA-4 Lightning Surge Protected 4-Position RF Coax Switch

Easy access to Arc-Plug® cartridge through front panel allows permanent switch mounting to any surface.

NEW



also available with N-type connectors

- Exclusive center "off" (ground) position internally disconnects and grounds all antenna circuits for maximum protection when operator is away from the station — an Alpha Delta first!
- Incorporates the famous replaceable Arc-Plug® cartridge for continuous protection of the active antenna circuit. Unused antenna circuits are automatically grounded — an Alpha Delta first!
- The Model DELTA-4 Switch features a custom designed cast housing with constant impedance micro-strip cavity construction for outstanding performance through UHF. No lossy wafer switches are used.

- Positive detent roller bearing switch drive tells you which position you're in . . . without guessing . . . without looking.
- DELTA-4 handles full legal power.
- Designed and produced in the U.S.A. by Alpha Delta.

Model DELTA-4 (UHF connectors, 500 MHz) \$74.95
Model DELTA-4/N (N-type connectors, 1.3 GHz) \$89.95

Available from your local Alpha Delta Dealer or direct. Add \$4.00 shipping and handling (U.S.A. only) Exports quoted.

See Data Sheet for surge limitations.

ALPHA DELTA COMMUNICATIONS, INC.

P.O. Box 571, Centerville, OH 45459 • (513) 435-4772 Orders

current solutions to current problems



✓ 182

THE RF CONNECTION

"SPECIALIST IN RF CONNECTORS AND COAX"

Part No.	Description	Price
321-11064-03	BNC 2 PST 28 volt coaxial relay, Amphenol Insertion loss: 0 to 0.75GHz, 0.10db Power rating: 0 to 0.5GHz, 100 watts CW, 2 kw peak Isolation: 0.1 GHz: 45db, 0.2 GHz: 40db, 0.4 GHz: 35db	\$25 used tested
83-822	PL-259 Teflon, Amphenol	1.75
PL-259/ST	UHF Male Silver Teflon, USA	1.50
UG-21D/U	N Male RG-8, 213, 214, Amphenol	3.25
UG-21B/U	N Male RG-8, 213, 214, Kings	4.00
9913/PIN	N Male Pin for 9913, 9086, 8214 fits UG-21D/U & UG-21B/U N's	1.50
UG-21D/9913	N Male for RG-8 with 9913 Pin	3.95
UG-21B/9913	N Male for RG-8 with 9913 Pin	5.75
UG-146A/U	N Male to SO-239, Teflon USA	6.00
UG-83A/U	N Female to SO-239, Teflon USA	6.00

"THIS LIST REPRESENTS ONLY A FRACTION OF OUR HUGE INVENTORY"

THE R.F. CONNECTION
213 North Frederick Ave. #11
Gaithersburg, MD 20877

(301) 840-5477

VISA/MASTERCARD: Add 4%
Prices Do Not Include Shipping

✓ 183

Factory Authorized Dealer & Service For

KENWOOD YAESU ICOM

**Call Us For
Great Prices & Great Service**

TOLL FREE ORDER LINE 1-800-344-3144
Continental U.S. & Texas

MEMPHIS, TN SAN ANTONIO, TEXAS
THE HAM CENTER
SALES AMATEUR RADIO SERVICE

5707A Mobud San Antonio, Texas 78238 (512) 680-6110
FAX (512) 647-8007

✓ 184

AUTOMATIC ROTOR BRAKE DELAY

Thomas V. Cefalo, Jr., WA1SPI, 29 Oak Street, Winchester, Massachusetts 01801

The immediate brake engagement that may occur when a rotation motor is de-energized is a problem common to some rotors. It doesn't usually present much trouble with a light antenna load, but with larger loads the additional stress applied to the rotor and the tower can be damaging. To avoid this possibility, manufacturers have incorporated a separate brake control into their rotor control units which lets the operator manually operate the brake. This solves the problem for the most part, unless the operator should accidentally engage the brake while the antenna is turning.

I've designed a circuit that automatically delays the rotor brake, giving the antenna time to stop turning. I'll describe its operation and construction here.

Theory of operation

The circuit shown in **Figure 1** is used with a Cornell-Dubilier HAM II/CD44 rotor system. The circuit is run by a separate power supply. Using the separate power supply cuts down on the number of modifications you need to make to the control unit, and leaves the original circuitry pretty much intact. I used CMOS integrated circuits to reduce the power requirements and provide a higher noise immunity.

Delay circuit operation is simple and straightforward. NAND gates and a multivibrator are the main components performing the delay function. The logic timing diagram is shown in **Figure 2**.

The brake switch is connected to a latch composed of two NAND gates (U2A and U2B) to debounce the switch contacts. U1 is a multivibrator configured for monostable operation and triggered from the rising edge of a pulse. One output of the latch (pin 3) is connected to the positive trigger input of the multivibrator. The gate inputs for U2C of brake relay RY1 are connected to pin 3 of the latch and the inverted output \bar{Q} of the multivibrator. When the brake switch is depressed, pin 3 of the latch transitions to a low, which forces the output of U2C to a high state. This causes transistor Q1 to become forward biased, turning on brake relay RY1. The relay contacts are connected in series with the primary of the rotor control

unit's power transformer, disengaging the brake when power is applied.

The other output of the latch (pin 4) is connected to the switching transistor Q2 of the second relay RY2. This relay guarantees that the rotor's motor is switched off when the brake switch is released. When the brake switch is depressed, pin 4 of the latch transitions from a low to a high. This forward biases the transistor turning on RY2, making power available to the rotation motor's direction switches. You can rotate the antenna with the brake disengaged by depressing the control unit direction switches.

The direction and brake switch can be released simultaneously, just as the antenna reaches the location you've chosen. As you release the brake switch, pin 4 of the latch transitions to a low level; this switches RY2 off and disconnects the power to the motor. At the same time, pin 3 of the latch transitions to a high level. The multivibrator triggers from the rising edge, causing \bar{Q} to pulse (see **Figure 2**). The external timing capacitor and resistor determine the width of the pulse and the brake remains disengaged for the duration. When the pulse-timing constant has elapsed, \bar{Q} switches back to a high level and the output of U2C transitions to a low. This turns the brake relay off, and the brake engages.

The brake is delayed by the width of the multivibrator's pulse. Because the antenna has stopped turning in the meantime, no damage is caused when the brake engages. You can adjust the delay from approximately 1 to 3.5 seconds. Use the following guidelines: $C_x > 1000$ pF, and $10\text{ k} < R_x < 1$ meg, to obtain other delay times from **Equation 1**.

$$T_d = 2.48 \times R_x \times C_x \quad (1)$$

To prevent the brake from disengaging on power-up, I connected an RC network to the master reset input (pin 9 of U1). This network generates a pulse when power is first applied, causing the multivibrator to reset. This forces \bar{Q} to remain high. I've also included an LED, which indicates the status of the brake.

FIGURE 1

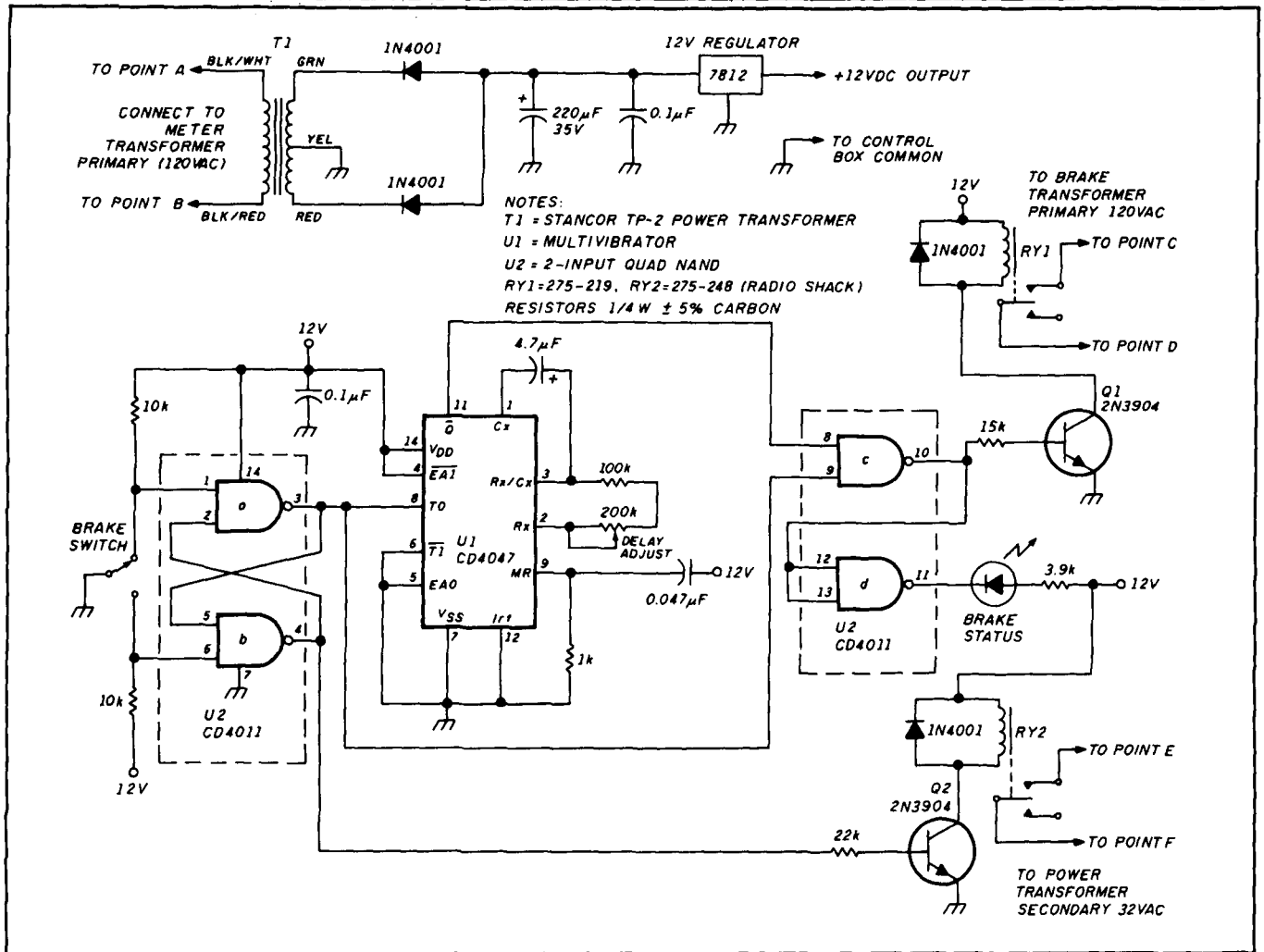

Brake delay and power-supply schematic.

FIGURE 2

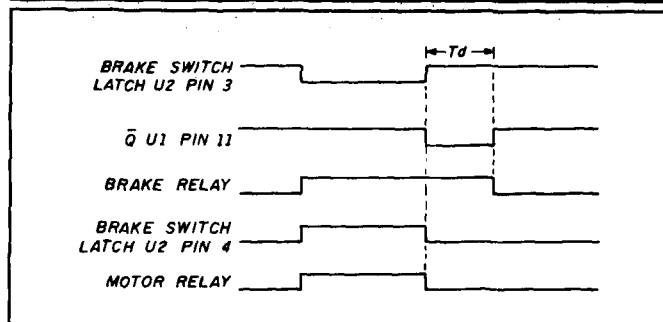

Logic timing diagram.

The power supply is a standard full-wave center-tapped rectifier with a secondary rating of 26-volts CT. It provides a maximum current of 150 mA. The delaying circuit draws a maximum current of 106 mA. Use any type of power supply that fits in the control box and supplies the current required by the delay circuit.

Construction

I built the circuit on a 3-1/2" x 2" vector pc board using

point-to-point wiring. Both the delaying circuit and the power supply (except for transformer T1) reside on the vector board. I inserted push-in type solder lugs into the board to provide a point for external wire connections.

I mounted the transformer in the upper section of the control unit's chassis on two 1/4" standoffs. I placed it at the end of the switching levels next to the meter transformer. The pc board is attached to the bottom of the chassis under the meter transformer with four 1/4" standoffs.

You can mount the brake status LED on the front panel. If you put it between the on/off and calibration switch it will be convenient and easy to see.

Wiring

Figure 3 shows the wiring details for installing the delaying circuit into the control unit. Remove the two wires from the brake switch and connect them to the RY1 contacts. Connect the common side of the brake switch to ground. Run a wire from the normally open terminal of the brake switch to pin 6 of U2B, and connect a wire from the normally closed terminal to pin 1 of U2A.

Locate the wire connected to the common terminal of both direction switches. Remove this wire from the direction switch and attach it to one of the switching contacts on RY2. Run a

FIGURE 3

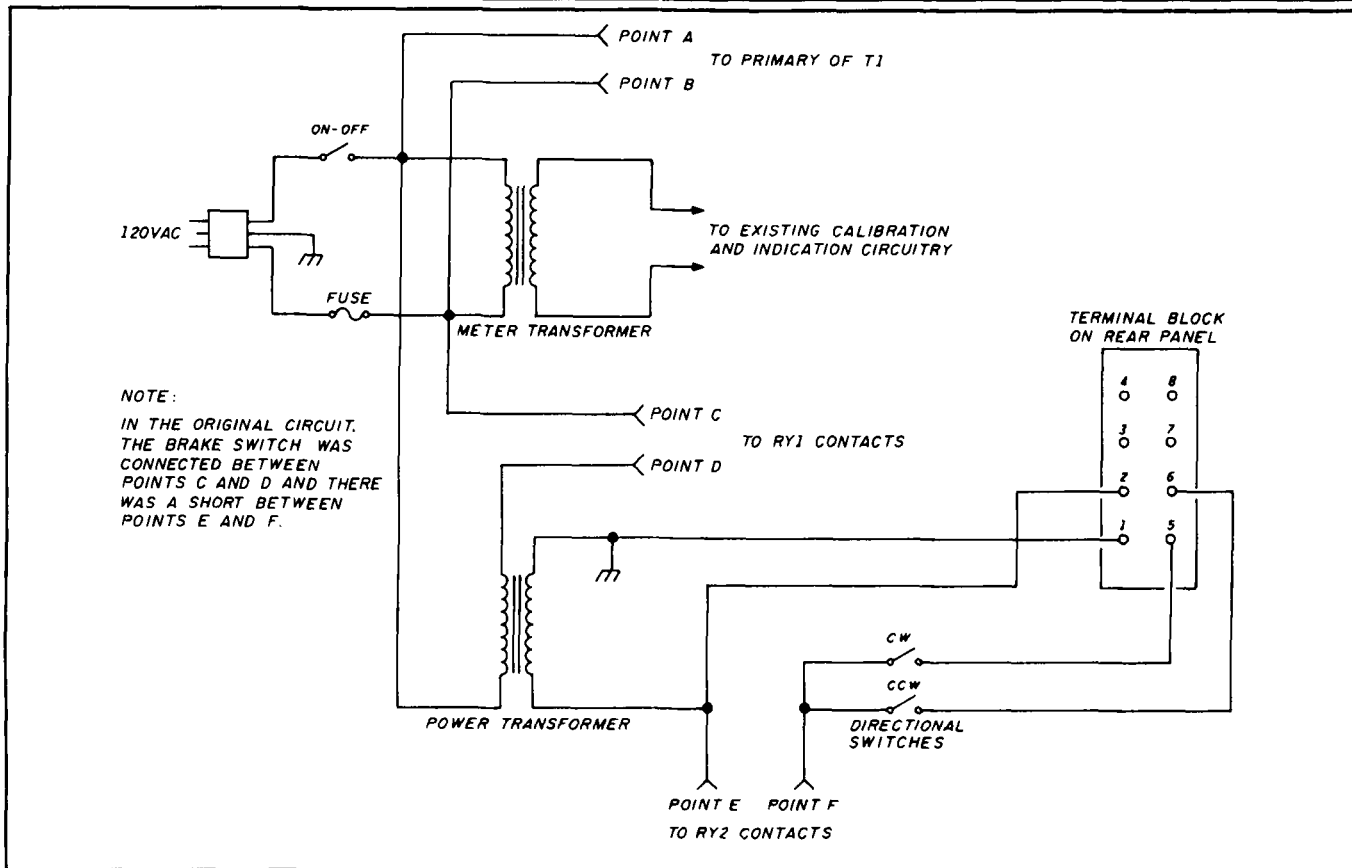

Control unit wiring modifications.

wire between the other contact on RY2 and the common terminal of both direction switches.

Connect the primary leads of power transformer T1* in parallel with the primary of the meter transformer. Now connect the secondary leads of T1 and the leads for the LED to the pc board. Finally, mount the common ground of the delay circuit to the control unit's chassis ground and the system is ready to use.

Conclusion

The delay circuit provides a simple solution to a problem that could result in some costly damage to your antenna system. The circuit prolongs rotor life because it eliminates the stresses associated with sudden stops. From the operator's standpoint, the control unit operates just as it did originally; however, the brake can no longer be accidentally or incorrectly engaged.

The modifications have a minimal impact on the control unit and the circuit is easy to build and install. Although the system I described is used with the CD44, you can adapt the circuit for other rotor systems using controllable brakes. 

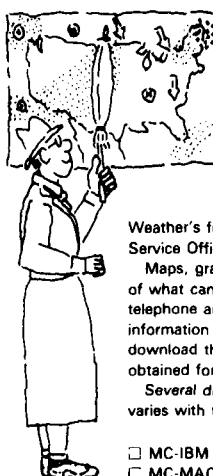

WEATHER SOFTWARE

ACCU-WEATHER FORECASTER is a menu driven program that allows the user to tap into Accu-Weather's extensive computerized database. In addition to Accu-Weather's forecasts, you can get hourly updates from National Weather Service Offices nationwide.

Maps, graphs, pictures, charts, and narrative descriptions are just part of what can be downloaded to your MS-DOS computer. To save telephone and hook-up charges, tell your computer first exactly what information you want. Then call ACCU-WEATHER; the computer will download the files you want and save them to disk. Information can be obtained for the entire United States or a specific geographical region.

Several different services are available from ACCU-WEATHER. Price varies with the service and time of day that the computer is accessed.

MC-IBM \$89.95
 MC-MAC \$89.95

Please enclose \$3.75 shipping & handling

HAM RADIO BOOKSTORE

GREENVILLE, NH 03048 603-878-1441

*Radio Shack carries a transformer (P/N 273-1366) rated at 25.2 volts CT at 450 mA. Dig-Key carries a similar transformer (P/N T105-ND) rated at 28 volts CT at 160 mA. Ed

HAM MART

Ham Radio's guide to help you find your local Amateur Radio Dealer

CALIFORNIA

A-TECH ELECTRONICS
1033 Hollywood Way
Burbank, CA 91505
(818) 845-9203
New Ham Store and Ready to Make a Deal!

JUN'S ELECTRONICS
3919 Sepulveda Blvd.
Culver City, CA 90230
(213) 390-8003
(800) 882-1343 Trades
Habla Espanol

COLORADO

ALLIED APPLIANCE & RADIO
4253 South Broadway
Englewood, CO 80110
(303) 761-7305
1 (800) 321-7305 (Orders only)
Rocky Mts Amateur/Shortwave Specialists,
Ten-Tec, Yaesu, JRC-NRD, Sony, MFJ,
KLM, and other fine gear. New and used.
Visa/MC. Antennas, books, discount prices
too!

COLORADO COMM CENTER
525 East 70th Ave.
Suite One West
Denver, CO 80229
(303) 288-7373
(800) 227-7373
Stocking all major lines
Kenwood Yaesu, Encomm, ICOM

CONNECTICUT

HATRY ELECTRONICS
500 Ledyard St. (South)
Hartford, CT 06114
(203) 527-1881
Call today. Friendly one-stop shopping
at prices you can afford.

DELAWARE

AMATEUR & ADVANCED
COMMUNICATIONS
3208 Concord Pike
Wilmington, DE 19803
(302) 478-2757
Delaware's Friendliest Ham Store.

DELAWARE AMATEUR SUPPLY
71 Meadow Road
New Castle, DE 19720
(302) 328-7728
(800) 441-7008
Icom, Ten-Tec, Microlog, Yaesu, Kenwood,
Santec, KDK, and more. One mile off I-95,
no sales tax.

FLORIDA

AMATEUR ELECTRONIC SUPPLY
1898 Drew Street
Clearwater, FL 33575
(813) 461-4267
Clearwater Branch
West Coast's only full service
Amateur Radio Store.
Hours Mon.-Fri. 9-5:30, Sat. 9-3

AMATEUR ELECTRONIC SUPPLY
621 Commonwealth Ave.
Orlando, FL 32803
(305) 894-3238
Fla. Wats: 1 (800) 432-9424
Outside Fla: 1 (800) 327-1917
Hours Mon.-Fri. 9-5:30, Sat. 9-3

HAWAII

HONOLULU ELECTRONICS
819 Keeaumoku Street
Honolulu, HI 96814
(808) 949-5564
Kenwood, ICOM, Yaesu, Hy-Gain, Cush-
craft, AEA, KLM, Tri-Ex Towers, Fluke,
Belden, Astron, etc.

IDAHO

ROSS DISTRIBUTING COMPANY
78 South State Street
P.O. Box 234
Preston, ID 83263
(208) 852-0830
Mon. 9-2; Tues.-Fri. 9-6; Sat. 9-2
Stock All Major Brands
Over 7000 Ham Related Items on Hand

ILLINOIS

ERICKSON COMMUNICATIONS, INC.
5456 N. Milwaukee Avenue
Chicago, IL 60630
(312) 631-5181
Hours: Mon. - Fri. 9-5:30, Sat. 9-3

INDIANA

THE HAM STATION
220 N. Fulton Avenue
Evansville, IN 47710
(800) 523-7731
(812) 422-0231
ICOM, Yaesu, Ten-Tec, Cushcraft, Hy-Gain,
AEA & others.

MARYLAND

MARYLAND RADIO CENTER
8576 Laureldale Drive
Laurel, MD 20707
(301) 725-1212
Kenwood, Ten-Tec, Kantronics. Full service
dealer.
Mon.-Fri. 10-7, Sat. 9-5

MASSACHUSETTS

TEL-COM, INC.
675 Great Road, Rte. 119
Littleton, MA 01460
(508) 486-3400
(508) 486-3040
The Ham Store of New England
You Can Rely On.

MISSOURI

MISSOURI RADIO CENTER
102 NW Business Park Lane
Kansas City, MO 64150
(800) 821-7323
Missouri: (816) 741-8118
ICOM, Kenwood, Yaesu
Same day service, low prices.

NEVADA

AMATEUR ELECTRONIC SUPPLY
1072 N. Rancho Drive
Las Vegas, NV 89106
(702) 647-3114
Dale Porray "Squeak," AD7K
Outside Nev: 1 (800) 634-6227
Hours M-F 9-5:30, Sat. 9-3

NEW HAMPSHIRE

RIVENDELL ELECTRONICS
8 Londonderry Road
Derry, N. H. 03038
(603) 434-5371
Hours Mon.-Sat. 10-5; Thurs. 10-7
Closed Sun/Holidays

NEW JERSEY

ABARIS SYSTEMS
276 Oriental Place
Lyndhurst, NJ 07071
(201) 939-0015
Don WB2GPU
ARRL, Astatic, Astron, B&W, Belden,
Bencher, Hustler, Kenwood, Larsen, RF
Concepts, Tonna and much, much more!
Tues.-Fri. 10AM-7:30PM
Thurs. 10AM-9:00PM
Sat. 10AM-4:00PM
Visa/MC

KJI ELECTRONICS
66 Skytop Road
Cedar Grove, NJ 07009
(201) 239-4389
Gene K2KJI
Maryann K2RVH
Distributor of: KLM, Mirage, ICOM, Larsen,
Lunar, Astron. Wholesale - retail.

HAM MART

NEW YORK

BARRY ELECTRONICS
512 Broadway
New York, NY 10012
(212) 925-7000
New York City's Largest Full Service Ham
and Commercial Radio Store.

VHF COMMUNICATIONS
280 Tiffany Avenue
Jamestown, NY 14701
(716) 664-6345
Open 8:00 AM till 5:30 PM
Evenings, Saturday and Sunday by appoint-
ment. Western New York's finest Amateur
dealer. Featuring ICOM "The World System."

OHIO

AMATEUR ELECTRONIC SUPPLY
28940 Euclid Avenue
Wickliffe, OH 44092 (Cleveland Area)
(216) 585-7388
Ohio Wats: 1 (800) 362-0290
Outside Ohio: 1 (800) 321-3594
Hours Mon.-Fri. 9-5:30, Sat. 9-3

DEBCO ELECTRONICS, INC.
3931 Edwards Road
Cincinnati, OHIO 45209
(513) 531-4499
Mon.-Sat. 10AM-9PM, Sun. 12Noon-6PM
We buy and sell all types of electronic parts.

UNIVERSAL AMATEUR RADIO, INC.
1280 Aida Drive
Reynoldsburg (Columbus), OH
43068
(614) 866-4267
Featuring Kenwood, Yaesu, Icom,
and other fine gear. Factory author-
ized sales and service. Shortwave
specialists. Near I-270 and airport.

PENNSYLVANIA

HAMTRONICS,
Div. of Trevoise Electronics
4033 Brownsville Road
Trevoise, PA 19047
(215) 357-1400
Same Location for over 30 Years

TEXAS

K COMM dba THE HAM STORE
5707A Mobud
San Antonio, TX 78238
(512) 680-6110
(800) 344-3144
Stocking all major lines. San Antonio's Ham
Store. Great Prices — Great Service. Factory
authorized sales and service.
Hours: Mon.-Fri. 10-6; Sat. 9-3

MADISON ELECTRONICS SUPPLY
3621 Fannin
Houston, TX 77004
(713) 520-7300
Christmas?? Now??

MISSION COMMUNICATIONS
11903 Aleif Clodine
Suite 500 (Corner Harwin & Kirkwood)
Houston, Texas 77082
(713) 879-7764
Now in Southwest Houston—full line of
equipment. All the essentials and extras for
the "ham."

WISCONSIN

AMATEUR ELECTRONIC SUPPLY
4828 W. Fond du Lac Avenue
Milwaukee, WI 53216
(414) 442-4200
Wisc. Wats: 1 (800) 242-5195
Outside Wisc: 1 (800) 558-0411
Mon.-Fri. 9-5:30, Sat. 9-3

Dealers:

YOU SHOULD BE HERE TOO!
Contact Ham Radio now for
complete details.

"ONLINE" U.S. CALL DIRECTORY

Hamcall service gives you all hams via
your computer & modem. Updated each
month! Only \$29.95 per year. Unlimited
use - you pay for phone call.

BUCKMASTER PUBLISHING
Route 3, Box 56
Mineral, Virginia 23117
703/894-5777 visa/mc 800/282-5628

✓ 185

Repeater Solar Power

The \$289.95 Bullet-Tested QRV Solar Power Supply keeps your
repeater on the air 'round the clock or powers your 100w HF station
60 hrs a month. Control circuit speeds charge, protects gel cells &
sealed batteries. Fully assembled, QRV, portable. Easily expanded.
Add \$10 S&H Info \$1
AntennasWest
Box 50062, BS Provo, UT 84605
(801) 373-8425

✓ 174

Mobiler's Dream!

Can you use a 6 dB stronger signal?
Would 50% more bandwidth be helpful?
Our SE-40 mobile antenna is the answer.
Handles 600 watts for another 6 dB.
SE-40, 40 - 10 meters; SE-75, 75 - 15 meters.

County Hunters Software

Designed by a top county hunter for county
hunters. Works on all IBM type computers.

R-4C Enhancements

Write for catalog

From the performance company:

Sherwood Engineering Inc.

1268 South Ogden Street, Denver, CO 80210
(303) 722-2257 Monday - Friday 9 A.M. - 5 P.M.

Sales, Service, Installations available from:

Design Electronics Ohio, KN8Z, Doc Sheller
(614) 836-5711 Days, (614) 836-3376 Evenings
LTA Industries, K3LR, Tim Duffy
(412) 528-9302 or (216) 533-7916

PC HF FACSIMILE 4.0 \$99



Actual VGA Screen Photo

The best computer FAX system just got better!

A complete facsimile reception system
for the IBM PC or Compatible. Receives
up to 16 intensity levels.

Includes:
Demodulator Software
Frequency List
80 Page Manual
Tutorial Cassette
Interpretation Guide

Features:
Print on Epson, or HP Laser Jet
Disk Save, Zooming, Image processing
Unattended Image Capture and much more

Software Systems Consulting
1303 S. Ola Vista, San Clemente, CA. 92672
(714)-498-5784

✓ 186

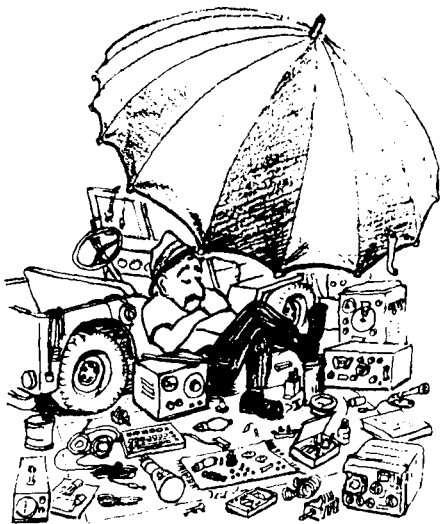

FLEA MARKET

RATES Noncommercial ads 10¢ per word; commercial ads 60¢ per word **both payable in advance**. No cash discounts or agency commissions allowed.

HAMFESTS Sponsored by non-profit organizations receive one free Flea Market ad (subject to our editing) on a space available basis only. Repeat insertions of hamfest ads pay the non-commercial rate.

COPY No special layout or arrangements available. Material should be typewritten or clearly printed (not all capitals) and must include full name and address. We reserve the right to reject unsuitable copy. **Ham Radio** cannot check each advertiser and thus cannot be held responsible for claims made. Liability for correctness of material limited to corrected ad in next available issue.

DEADLINE 15th of second preceding month.

SEND MATERIAL TO: Flea Market, Ham Radio, Greenville, N. H. 03048.

BEGINNER'S RADIO CLEARINGHOUSE. On a space available basis, we are going to offer you, OUR SUBSCRIBER, free of charge, a chance to find a home for your used equipment with a new Ham. Please send us a short description of what you want to sell along with price, name, address and phone number. We'll run it once in a special section of the classified ads under the heading of BEGINNER'S RADIO CLEARINGHOUSE. Please limit your ad to 20 words or less.

CUSTOM MADE EMBROIDERED PATCHES. Any size, shape, colors. Five patch minimum. Free sample, prices and ordering information. HEIN SPECIALTIES, Inc., 7960 SW Manitou Trail, Glen Arbor, MI 49636. (616) 334-4385.

HY-GAIN 2BDQ 40 & 80M shortened inverted-V, \$25. Mosley 20m 3-el beam (all parts except elements/boom), \$10. D. Heise, AA6EE, 16832 Whirlwind, Ramona, CA 92065. (619) 789-3674 evs.

WANTED!! AEA MM-3 KEYS (The Morse Machine) serial number 43 stolen from DEN-TRONICS' booth at the Dallas Hamfest. Unit may be returned to either AEA or DEN-TRONICS no questions asked. If not returned, surveillance video tapes will be released to local law enforcement agencies.

COLLINS KWM/HF360 Repairs and discount accessories. Kirby, K7WOC. (713) 320-2324.

SOFTWARE KAM—C-64. Does anyone know of any new software for the KAM—C-64. Not KAMTERM. Please call or write Luke, WB5JAP, 2109 Sandy Lane, Irving TX 75060. (214) 986-5219 evenings.

FLOOD YOUR MAILBOX! You get 100's of radio & electronic & computer specialty catalogs. Send \$10 with your name & address to: Electronic List Service, PO Box 1683, Brookline, MA 02146.

DIGITAL INDUCTANCE/CAPACITANCE meter as featured in July 1988 Radio Electronics Magazine. Inductance from 0.01 uhy to 10 mhy, capacitance from 0.10 pf to 0.10 ufd. Automatic range, automatic zero, accuracy +/-3%. Assembled \$149.95, kit \$129.95 (digital frequency counter needed during calibration). Add \$5.00 shipping. SASE for detailed specification. Almost All Digital Electronics, 5211—117th Avenue SE, Bellevue, WA 98006.

WANTED: The UHF Compendium, Pt 1 & 2, by K. Weiner, DJ9HO Art, W6LGO, 34 Laurel Avenue, Petaluma, CA 94952.

FOR SALE: All only two months old and in mint condition: ICOM 3200A (with service manual), Kantronics KPC-4 (with latest firmware), Astron 20A, Comet 2M/440 antenna, 40' coax, and other goodies. \$660 (firm). Will send COD. Richard, WF7A, in callbook.

LASER COMPONENTS! Surplus tubes, power supplies, optics. Build a working LASER for under \$75.00. Free plans with order. \$1.00 (refundable) brings list. FundServ, 1546D Peaceful Lane, Clearwater, FL 34616.

WANTED: Swan 350 meter 0-800 on bottom. R. Mollentine, WA0KKC, 7139 Hardy, Overland Park, KS 66204.

HT-CLONE BATTERIES: ICOM: BP-3S Double BP3 "Wall Chargeable" \$43.95, BP5 \$42.95, Yaesu: FN82 \$21.95, San-tec 142/442/1200 (3 Pin) \$22.95 "Rebuilding: Send-Ur-Pack" Icom BP3 \$20, BP5 \$28, BP7/B \$34, BP70 \$30, Yaesu FNB4/4A \$37, Kenwood PB21 \$18, PB25/H/26 \$28, T-T 2991 \$28 "U-Do-It Repair Inserts" Icom: PB2 \$18.95, BP3 \$16.95, BP5 \$22.95, BP7/BP8 \$28.95, Kenwood: PB21 \$12.95, PB24/25/26 \$19.95, Azden 300 \$19.95, Yaesu: FNB4/4A \$32.95, Tempo: S1,2,4,5,15/450 \$22.95, 12V/5Ahr Porta-Pac w/chgr \$49.95, "Antennas" 2mtr 5/8-Tel/BNC \$18.95 "Telephone/Pager & Commercial Packs" "Free Catalog" \$3 shipping/order PA +6%. VISA/MC +\$2. (814) 623-7000. CUNARD ASSOCIATES, Dept H, RD 6, Box 104, Bedford, PA 15522.

AVANTEK ATF10135, \$12.00, MMIC's, P.C. board, SASE: WA3IAC, 7148 Montague St, Philadelphia, PA 19135.

HAM SOFTWARE and other "shareware" for IBM/compatibles. Large SASE for catalog. JK&S, POB 50521, Indianapolis, IN 46250-0521.

100 QSL CARDS \$6. \$3 thereafter. Grid square printed free. Shipped postpaid within two weeks. Guaranteed correct! Free samples. Shell Printing, KD9KW, Box 50B, Rockton, IL 61072.

NEED SCHEMATIC of Hallicrafter SX110 receiver. Will pay reasonable price. A.T. Butler, 1157 Rivermont Drive, Melbourne, FL 32935.

HAM RADIO. Complete run Volume 1, No. 1 (March 1968) through May 1982. Very good condition. \$95. W1JE, 6 Locust Grove Road, Harwich, MA 02645.

RADIO SHACK COLOR COMPUTER. Ham software and hardware. Free catalog. Dynamic Electronics, Box 896, Huntsville, AL 35640. (205) 773-2758.

REPEATER JAMMERS? Pinpoint them with our "Handi-Finder" — attaches to HT. Kits: \$24.95, or less! Club project discounts!! NOARD, 29460-H Lorain, Cleveland, OH 44070. (216) 777-9460.

HAM SOFTWARE IBM/Compatibles. 10 disks \$26.95. MC/VISA/Discover. N5ABV EAPCO, Keller, TX 76248-0014. (817) 498-4242.

WANTED: Old tube HiFi and studio components, loudspeakers, turntables, related magazines etc. Most makes and models, any condition. Jack Smith, 288 Winter Street, North Andover, MA 01845. (508) 686-7250.

UHF TEST EQUIPMENT: Hewlett-Packard TS403 (616B), UHF Signal Generator 1.8-4 GHz \$50, Jerrold VHF-UHF sweep generators \$50.00, Tektronix 8611 dual trace scopes (DC-3900 MHz) no leads. \$50. Avionics glide path and localizer sig. gen. \$75 checked, \$40 unchecked. AUL 1-7 GHz sig. gen. \$50. WVV5B, POB 460, Brookshire, TX 77423.

POLICE/FIREFIGHTER HAMS. Please send your Call, Name, Address, Rank, Department Name, for inclusion in special roster available late 1989. Capt. Bob Blakeslee, N2IHFQ, 1-1/2 Wamcomber Ave, Binghamton, NY 13901.

WANTED: Ham equipment and other property. The Radio Club of Junior High School 22 NYC, Inc. is a nonprofit organization, granted 501(C)(3) status by the IRS, incorporated with the goal of using the theme of Ham Radio to further and enhance the education of young people nationwide. Your property donation or financial support would be greatly appreciated and acknowledged with a receipt for your tax deductible contribution. Labor Day and the new term are almost here. Do it, don't wait till the end of the year, make your decision to donate that equipment now. We depend on you. Please write us at: PO Box 1052, New York, NY 10002. Round the clock hotline: (516) 674-4072. Thank you!

IBM-PC SOFTWARE FOR PK-232. New CompRtly II is the complete RTTY/CW program for IBM-PC's and compatibles. Now with larger buffers, better support for packet units, pictures, much more. Virtually any speed ASCII, BAUDOT, CW. Text entry via built-in screen editor! Adjustable split screen display. Instant mode/speed change. Hardcopy, disccopy, break-in buffer, select calling, text file transfer, customizable full screen logging, 24 programmable 1000 character messages. Ideal for MARS and traffic handling. Requires 256K PC or AT compatible, serial port, RS-232C TU. \$65. Send call letters (including MARS) with order. David A. Rice, KC2HO, 144 N. Putt Corners Rd, New Patz, NY 12561.

INTERESTED IN PUBLIC SERVICE? Join your local Radio Emergency Associated Communications Team. In Pennsylvania call 717-938-6943 or write REACT, 1160 Old Trail Rd, Etners, PA 17319.

GENERAL CLASS TUTOR PROGRAM for PC compatibles. \$20.00. Miss. residents add 6%. SASE for details. Jim Burrell, N5NEZ, 316C Critz, Starkville, MS 39759.

10 YEAR CLEANOUT SALE. Shack overloaded. Must vacate 2000 cu/ft area of test equipment, microwave, radios, antiques, parts, variacs, very interesting collection. Send stamp for complete list. Joseph Cohen, 200 Woodside, Winthrop, MA 02152. (617) 846-6312.

PARTS BONANZA. Limited quantity. Commodore "Pet" computers removed from service \$49.95 (may work!). Hard Drives for Pets, tons of parts "AS IS" \$29.95. Commodore Printer Heads Special—Consult Factory. Q.E.P. Co., Inc., Kasara Microsystems Division, Stony Point, NY 10980. 1-800-248-2983 or 914-942-2252. Visa/MC/COD.

WANTED: All types of Electron Tubes. Call toll free 1-800-421-9397 or 1-612-429-9397. C & N Electronics, Harold Bramstedt, 6104 Egg Lake Road, Hugo, MN 55038.

UHF PARTS. GaAs Fets, mmics, chip caps, feedthrus, teflon pcb, high Q trimmers. Moonbounce quality preamps. Electronic sequencer boards. Send SASE for complete list or call (313) 753-4581 evenings. MICROWAVE COMPONENTS, PO Box 1697, Taylor, MI 48180.

SELL. Millen SS Dipper 90652 \$150. Tube GDO with two extra tubes \$100. Antenna bridge \$50. Heather IO-4235 two-trace 35 MHz scope \$100. (needs HV rectifier). Heath 4505 scope calibrator \$25; Heath IM-2420 counter \$25. New Bird slugs 1000, 1000w \$50 each. Joe Darmento, W4SXX, 11170 S.T.F., Merritt Island, FL 32952. (407) 773-0796.

HANDICAPPED NOVICE needs HF equipment donated—anything please. KA3OUE, (412) 531-7443 anytime.

IMRA International Mission Radio Association helps missionaries. Equipment loaned. Weekday net, 14.280 MHz, 1-3 PM Eastern. Nine hundred Amateurs in 40 countries. Rev. Thomas Sable, S.J., University of Scranton, Scranton, PA 18515.

VHF-UHF-SHF. Large SASE. West Coast VHFer, POB 865, Holbrook, AZ 86025.

CHASSIS & CABINET KITS. SASE. K3IWK, 5120 Harmony Grove Rd, Dover, PA 17315.

ANALOG AND RF CONSULTING for the San Francisco Bay area. Commercial and military circuits and systems. James Long, Ph.D., N6YB (408) 733-8329.

RTTY JOURNAL—Now in our 36th year. Read about RTTY, AMTOR, PACKET, MSO'S, RTTY CONTESTING, RTTY DX and much more. Year's subscription to RTTY JOURNAL \$10.00, foreign slightly higher. Order from: RTTY JOURNAL, 9085 La Casita Ave., Fountain Valley, CA 92708.

RUBBER STAMPS: 3 lines \$5.00 PPD. Send check or MO to G.L. Pierce, 5521 Birksdale Way, San Diego, CA 92117. SASE brings information.

ELECTRON TUBES: Receiving, transmitting, microwave... all types available. Large stock. Next day delivery, most cases. DAILY ELECTRONICS, PO Box 5029, Compton, CA 90224. (213) 774-1255.

"HAMLOG" COMPUTER PROGRAM. Full features, 17 modules. Auto-logs, 7-band WAS/DXCC, Apple \$19.95. IBM, CP/M, KAYPRO, Tandy, C128 \$24.95. HR-KA1AWH, POB 2015, Peabody, MA 01960.

RECONDITIONED TEST EQUIPMENT \$1.25 for catalog. Walter, 2697 Nickel, San Pablo, CA 94806.

COMING EVENTS

Activities — "Places to go . . ."

SPECIAL REQUEST TO ALL AMATEUR RADIO PUBLICITY COORDINATORS: PLEASE INDICATE IN YOUR ANNOUNCEMENTS WHETHER OR NOT YOUR HAMFEST LOCATION, CLASSES, EXAMS, MEETINGS, FLEA MARKETS, ETC. ARE WHEELCHAIR ACCESSIBLE. THIS INFORMATION WOULD BE GREATLY APPRECIATED BY OUR BROTHER/SISTER HAMS WITH LIMITED PHYSICAL ABILITY.

CANCELLATION NOTICE. The BARC Packet Radio Symposium scheduled for September 16 at Georgian College, Barrie, Ontario has been cancelled.

IOWA: August 5-6. The Cedar Valley ARC's Summerfest '89, Teamsters Hall, 5000 J Street SW, Cedar Rapids. 8 AM to 5 PM, August 5 and 8 AM to 3 PM August 6. Admission \$4. 12 and under free. For advance registration write Summerfest '89, Cliff Goldsberry, 2926 Shaffer Drive SW, Cedar Rapids, IA 52404. (319) 365-8649.

WISCONSIN: August 12. The tenth annual Rhinelander Swapfest sponsored by the Northwoods ARC, ARES, Tomahawk Rep. Assn and Rhinelander Rep. Assn., Rhinelander Ice Arena. Tickets \$1.00. Auction 1:00 PM. For information contact Leonard Bauman, K9RMM, 804 Lincoln Street, Rhinelander, WI 54501. (715) 369-3296 or 369-5564.

LOUISIANA: August 12-13. The Shreveport Amateur Radio Association (SARA) is hosting their 10th annual ARK-LA-TEX Hamfest in Shreveport's air-condition Convention Hall.

MINNESOTA: August 13. St. Cloud ARC Hamfest, Whitney Senior Center, St. Cloud. Ticket donation \$3. Extra ticket \$2. Contact SCARC, Box 141, St. Cloud, MN 56302.

PENNSYLVANIA: August 13. Mid-Atlantic ARC Hamfest, Bucks County Rt 611 Drive-In Theater, Warrington. Buyers admitted 8 AM. Admission \$3. For information call Al Maslin, W3DZ1 (215)446-4936 or write MARC, PO Box 352, Villanova, PA 19085.

INDIANA: August 13. The Porter County ARC's annual NW Indiana Hamfest and Computer Fair, Porter County Fairgrounds and Expo Center, Rt 49, east of Valparaiso. Admission \$3.50/advance; \$4/door. Kids under 12 free. For information/tickets contact Hamfest Committee, PCARC, PO Box 1782, Valparaiso, IN 46384.

NEW JERSEY: August 19. The 13th annual Ramapo Mountain ARC Hamfest and Computer Flea Market, American Legion Hall and Grounds, 65 Oak Street, Oakland. 8 AM to 1 PM. For more information contact Marc, WA2S, (201) 652-3118 or (201) 652-8493.

NEW YORK: August 19. The Finger Lakes Hamfest sponsored by the Tompkins County ARC, 4H-Acres, off Rt. 13, 7 miles north of Ithaca. Admission \$3. Under 18 free. Hand parking. For more information contact Bob, KD2IM (607) 347-4444.

WASHINGTON: August 19-20. Northwestern Division Convention & Tacoma Hamfair sponsored by the Radio Club of Tacoma (W7DK), Pacific Lutheran University. Saturday 9 to 5. Sunday 9 to 1. Preregistration \$5 to August 6; \$7 at the door. \$1 for non-hams. 12 and under free. For details write Radio Club of Tacoma, PO Box 11188, Tacoma, WA 98411 or phone RCT (206) 759-2040 or BillMorgan, W7GPR (206) 531-3821.

OHIO: August 20. W8VTD, The Warren Amateur Radio Association's Hamfest, Trumbull Branch Campus of Kent State University, Warren. Admission \$2.50/advance; \$3.00/door. Under 12 free. For information Warren ARA Hamfest, PO Box 809, Warren, OH 44482.

INDIANA: August 20. The Tippecanoe Amateur Radio Association's 18th annual Hamfest, Tippecanoe County Fairgrounds, Teal Road and 18th Street, Lafayette. Fairgrounds open 5 AM. For more information write D. C. Roberts, 5124 Jackson Highway, West Lafayette, IN 47906.

ILLINOIS: August 20. The Western Illinois ARC's Tri-State Swapfest '89, Eagles Alps Lodge, 3737 North 5th Street, Quincy, 8 AM to 3 PM. Admission \$2/advance; \$3/door. For information/reservations Michael Nowack, NA9Q, c/o WIARC, PO Box 3132, Quincy, IL 62301. (217)-224-8526.

ALASKA: August 26. The Arctic ARC's Hamfest/Swapmeet, 10th Avenue and Steese Highway, Fairbanks. Admission \$1.00. For information Joan Soutar, N0AJW, PO Box 81389, Fairbanks, AK 99708.

MISSOURI: August 27. The St. Charles ARC will sponsor Hamfest '89, Blanchette Park in St. Charles. 6:30 AM to 2:30 PM. Free admission and parking. Hand parking available. Contact Mike Nolan, KA0JXQ, 16 Gateswood Drive, St. Peters, MO 63376.

TENNESSEE: August 27. The Lebanon Hamfest sponsored by the Short Mountain Repeater Club, Cedars of Lebanon State Park, US 231, 7 miles north of Lebanon. For information contact Mary Alice Fanning, KA4GSB, 4936 Danby Drive, Nashville, TN 37211. (615) 832-3215.

NEW MEXICO: September 2-3. The Alamogordo ARC's fifth annual Hamfest, Otero County Fairgrounds, Alamogordo. Free admission.

PENNSYLVANIA: September 9. Uniontown ARC (W3PIE) will hold its 40th annual Gabfest, Club grounds, Old Pittsburgh Road, Uniontown. Registration \$3 or 2/\$5. For more information write UARC Gabfest, c/o John T. Cermak, WB3DOD, PO Box 433, Republic, PA 15475. (412) 246-2870.

FLORIDA: September 9-10. The Platinum Coast Amateur Radio Society presents the 24th annual Melbourne Hamfest, Melbourne Auditorium. Registration \$4 advance (SASE only), \$5 at the door. Hamfest 708 Dartmouth Avenue, Melbourne, FL 32901.

NORTH CAROLINA: October 1: JARSFEST '89, Benson American Legion Complex, 301 N. Benson NC 27504. 8 AM to 4 PM. For flyer SASE to Johnston Amateur Radio Society, PO Box 1154, Smithfield, NC 27577. (919)934-0486, 894-5479.

OPERATING EVENTS

"Things to do . . ."

August 5-6: Titusville, PA. From the birthplace of the oil industry, special event station K3HWL will operate from 1400Z to 2300Z each day from the site of the historic Perry Street railroad station to commemorate the fourth year of operation of the Oil Creek & Titusville Railroad. Sponsored by the Oil Creek Valley Radio Society. CW 3 710, 3 675, 7 110. SSB 7 250, 14 275, 28 350 MHz. For QSL send QSL and No. 10 SASE to Robert E. Myers, K3HWL, RD 1, Box 143-G, Titusville, PA 16354.

August 7-12: All-American Soap Box Derby. The Cuyahoga Falls ARC will operate special event station W8VPV during the 52nd running of the Derby. Monday-Friday 2200Z-0300Z. Saturday 1100Z-2000Z. Freq. 3.860, 14.240, 28.420. For certificate send large SASE by 9/20/89 to W8VPV, Box 614, Cuyahoga Falls, OH 44222.

August 12: The Arapahoe Radio Club's fifth annual ham radio expeditions to Colorado's 14,000-foot mountain peaks. CW frequency 14,050-14,060 with participants calling "CQ 14". Phone stations around 14,285 calling "CQ Fourteeners". Operation from 1600-1800Z. QSI direct of to K9AY, 7318 S. Birch Street, Littleton, CO 80122.

August 12-13: The Southcentral Conn. Amateur Radio Association will operate W1GB in the General portion of 80-15 and Novice 10m from Paul Newman's "Hole in the Wall Gang" camp for children with cancer and blood disorders. For a special QSL send QSL and SASE to K1PVT, Bill DeBenedetto, 55 Thompson St, 13E, East Haven, CT 06513.

August 16-18: Bridgewater, New Jersey. The Somerset County Office of Emergency Management will operate WC2ADK 1400-0100Z each day to promote Amateur Radio, R.A.C.E.S and Public Service at the annual 4-H Fair. Sugg. Freq. Lower 25 kHz of General 80-10m and 10m Novice. Visitors on 145,320 simplex. Send QSL and SASE to Somerset County OEM/4H, PO Box 3000, Somerville, NJ 08876.

August 19: Salisbury, New Hampshire. To commemorate Old Home Day, N1GCO will operate 1400Z to 2000Z on lower 25 kHz of General HF, 220/440 repeater and simplex and 145.07 packet. For special QSL send SASE to N1GCO, RFD 5, Box 42, Penacook, NH 03303.

August 19-Sept 3: The Jet Propulsion Laboratory ARC will operate W6VIO from 000Z August 19 through 2359Z Sept 3 to commemorate the Voyager 2 encounter with Neptune. This complete the Grand Tour. Primary SSB and SSTV frequency will be 14.235. Greatest activity will be weekday noons and evenings. For QSL, send QSL and SASE to W6VIO callbook address. DX stations QSL via bureau.

FREE 1989-90 Florida two meter repeater directories are currently being distributed by the Hernando County Amateur Radio Assn. of Brooksville, FL. Ask for one at any official Florida Welcome Center or SASE to Repeater Directory, Hernando County ARA, POB 1721, Brooksville, FL 34605-1721.

LAUREL ARC monthly (except December) Amateur exam sessions for all license classes. No fee is charged. Pre-registration is required. Call (301) 725-1212, Maryland Radio Center, 8576 Laureldale Drive, Laurel, MD 20707.

AMATEUR EXAMS in Wellesley, MA, Saturday, August 26, 10 AM. Please call Vern, ND1Z (508) 533-6822 by August 20 to book a spot. New and prospective Amateurs are most especially welcome.

NORTH COAST ARC 1989 LICENSE EXAMS. 12:30 PM, Saturdays February 11, April 15, June 10, August 12, October 14, December 9. N. Olmsted Community Cabin, S of Lorain on W. Park. Novice thru Extra. Walkins allowed. Talk in 145.29 repeater. For information Dan Sarama, KBBA, 15591 Rademaker Blvd, Brookpark, Ohio 44142, 267-5083 or Pauline Wells, KA8FOE, Rick Wells, K8SCI, 777-9460/779-8999.

AMATEUR RADIO CLASSES: For those people interested in obtaining a Novice (basic level) Ham license or upgrading to Tech/General, the Chelsea Civil Defense, in cooperation with QRA Radio Club, will sponsor Amateur Radio Communications classes evenings at Chelsea High School starting MARCH 7, 1989. For more information write Frank Masucci, K1BPN, 136 Grove Street, Chelsea, MA 02150. Please enclose your telephone number.

THE MIT UHF REPEATER ASSOCIATION and the MIT Radio Society offer monthly HAM EXAMS. All classes Novice to Extra. Wednesday, AUGUST 23, 7 PM, MIT Room 1-150, 77 Mass Avenue, Cambridge, MA. Reservations requested 2 days in advance. Contact Ron Hoffmann at (617) 484-2098. Exam fee \$4.50. Bring a copy of your current license (if any), two forms of picture ID, and a completed form 610 available from the FCC in Quincy, MA (617) 770-4023.

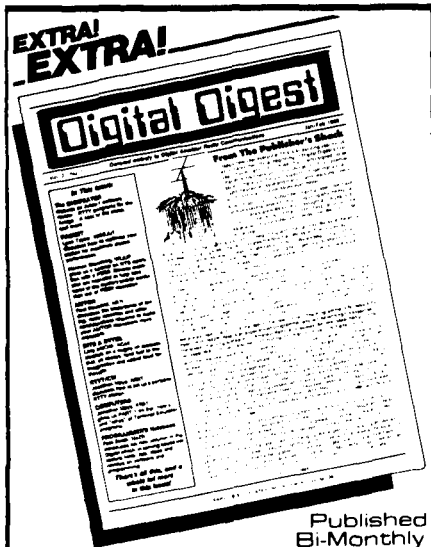

Read All About Your Favorite Modes Of Digital Communications!

★ **Subscribe Today!** ★

Digital Digest
4063 N. Goldenrod Road
Winter Park, FL 32792

\$16.00 Per Year
U.S. \$22.00 Elsewhere

Payable in U.S. Funds Only / Check or M.O. Preferred

N6KW QSL Cards

The finest QSL Cards at reasonable prices. Basic Cards, map cards, cartoon cards, photo cards and more. Your idea converted to ink or use standard designs. 747 ink colors, any card stock. Photos b/w or beautiful color. Have cards that fit your style. FREE SAMPLES - postage appreciated.

KW Litho - Dept. HR P.O. Box 17390
(817)332-3658 Ft. Worth, TX 76102

QRV *Slinky*

Indoor Antenna

for Apartment, Motel, Attic, & Portable Use

Small • Simple • Fast • Versatile • Effective •
Complete with 18 ft Decorator white feedline & all-transparent mounting hooks, line, and suction cups for installation anywhere.

Suspend in attic, basement, bedroom, hallway, staircase - horizontal, vertical or bent. Int. \$1.99

Extend in a minute. Zip out of sight in an instant.

Work all bands 40-10 w/ s1995 80-meter s6 95

a 15' indoor antenna -S3P&H Add-on
AntennasWest Box 5062, Provo, UT 84605 801-373-8425

✓ 174

**SAY YOU SAW IT
IN
HAM RADIO**

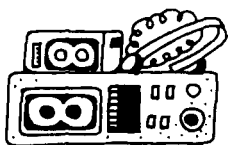

DX Forecaster

Garth Stonehocker, KØRYW

DXING DURING THE SUMMER QRN SEASON

An estimated 3600 thunderstorms are in progress around the world at any given time. They occur mostly in the tropical regions. These thunderstorms can be classified as air mass, frontal, or combinations of the two, depending on how they form. The main source of summertime QRN is the air mass thunderstorm.

During the evening DXing hours, air mass thunderstorm QRN may limit the usefulness of low band signals for local ragchewing and, for the most part, will rule out weak signal DX. The QRN, propagated from equatorial land regions or closer, increases the overall average noise level on the 80 and 160-meter bands. This happens because the "tropical" regions get closer to those of us in the Northern Hemisphere as the sun comes up to 23°N in the summer. As a result, a hop or two is cut from the thunderstorm noise propagation distance, adding a few dB to the overall noise. Florida leads the top thunderstorm producers of the closer areas; the eastern side of the Rocky Mountains in Colorado and Nebraska is next, followed by the southeastern part of the United States.

The air mass thunderstorm forms when the sun heats the ground. As the heat from the ground rises, it warms the air above, causing it to rise. As this heated air meets the colder air above, its moisture content condenses, forming clouds. The clouds — some of which are seized by the winds and carried into the jet stream to form the characteristic anvil-shaped top of a thunderhead at 30,000 to 40,000 feet — continue to rise until their condensed moisture forms drops heavy enough to fall as rain. Some drops are carried further upward and freeze into hail. This fast up-and-down motion generates static electricity strong enough to cause the air (as an insulator) to break down between a cloud



and the earth, or between one cloud and another. As the lightning stroke releases this energy, it produces electromagnetic pulses. Our receivers pick up the HF radio frequency pulses we call "noise." Most air mass storms form on afternoons when the humidity is above 50 percent, and last into the night before cooling off enough to dissipate. Air mass thunderstorms linger for several days until they release their moisture as rain, or slowly move on.

How can you communicate with DX stations on these lower bands? Directional antennas may help if the thunderstorm activity is in the opposite direction from the DX stations. If you can avoid pointing your beam at these areas, you can help minimize noise pickup. In fact, if you can get the back of the antenna pointed in that direction, you can use the front-to-back ratio (typically 15 dB) to further decrease noise pickup. This may mean working DX long path or over the Pole. If the ionosphere will support propagation in that direction, and no geomagnetic field disturbance is occurring, you may find this a solution to some of the summer noise problems. You may also want to change your operating hours. Since most air mass thunderstorms dissipate during the night and build to noise proportions with the heat that arrives after dawn each day, there's a minimum noise period from about 3 to 8 a.m. which offers good operating conditions.

Last-minute forecast

The higher frequency bands are expected to be best the third and fourth weeks of August, when the solar flux increases the MUF for long skip

openings. Don't expect many trans-equatorial openings in the evenings during the summer months. Sporadic E (E_s) short skip openings at midday should give the highest E region MUF in many years. Lower frequency signal strengths will decrease during daylight hours when the flux is high. Higher noise will also lead to poor conditions. Look for the best signals the first two and last weeks of the month. Thunderstorm noise will still be a problem in the evenings. Sporadic E short skip openings around sunset should help signals get through the noise.

Band-by-band summary

Six-meter sporadic E short skip conditions on some days will last anywhere from 30 minutes to a couple of hours around local noon. Expect about 1000 miles per hop.

Ten, 12, 15, and 17 meters will have quite a few short skip E_s openings and some long skip openings during the 27-day solar flux peak to southern areas of the world, in the daylight hours. Fifteen and 17 meters will be best for several hours as the MUF decreases for the evening.

Twenty, 30, and 40 meters will be useful for DX communications to most eastern, western, and northern areas of the world during daylight hours and into the evening most days, via long skip to 2000 miles per hop or short skip E_s , with 1000-mile hops. The period of daylight is still relatively long, but will be noticeably shorter by the end of the month.

Thirty, 40, 80, and 160 meters are all good for nighttime DX, even though the background noise will be severe in the evenings. The direction of the openings will rotate from the east to the south and then westward in the morning. If you want to avoid thunderstorm QRN, you may find sporadic E propagation helpful in the early evening toward the east and south. Try the early morning hours for communication paths to the west, and monitor WWVH or WWV on 2.5 and 5 MHz as beacons.

WESTERN USA

GMT	PDT	Directional Indicators							
		N	NE	E	SE	S	SW	W	NW
0000	5:00	12	17	15	10	10	10	10	10
0100	6:00	10	20	15	10	10	10	10	10
0200	7:00	10	20	15	10	10	10	10	10
0300	8:00	12	17	17	10	12	10	10	10
0400	9:00	12	15	17	12	15	10	10	10
0500	10:00	15	17	15	12	20	10	10	12
0600	11:00	15	17	12	15	20	10	10	15
0700	12:00	17	20	12	15	20	10	10	15
0800	1:00	20	20	15	15	20	10	10	17
0900	2:00	20	20	15	17	20	10	10	17
1000	3:00	20	20	15	20	20	12	12	17
1100	4:00	30	15	15	15	20	15	15	20
1200	5:00	17	15	10	15	20	15	15	20
1300	6:00	15	12	10	12	20	15	15	30
1400	7:00	15	12	10	10	30	17	17	20
1500	8:00	15	10	10	10	30	17	17	20
1600	9:00	17	10	10	10	20	17	17	20
1700	10:00	20	10	10	10	15	15	17	30
1800	11:00	20	12	10	10	12	10	17	17
1900	12:00	20	12	10	10	10	10	12	15
2000	1:00	20	12	10	10	10	10	10	15
2100	2:00	17	15	10	10	10	10	10	12
2200	3:00	15	15	12	10	10	10	10	12
2300	4:00	15	15	12	10	10	10	10	10

IGUST

MID USA

GMT	MDT	Directional Indicators							
		N	NE	E	SE	S	SW	W	NW
0000	6:00	15	17	15	10	10	10	10	10
0100	7:00	12	20	15	10	10	10	10	10
0200	8:00	10	20	15	10	12	10	10	10
0300	9:00	12	20	17	10	12	10	10	10
0400	10:00	15	17	17	12	15	10	10	10
0500	11:00	17	17	17	12	20	10	10	12
0600	12:00	20	20	15	15	20	10	10	15
0700	1:00	20	20	15	15	20	10	10	17
0800	2:00	20	30	15	15	20	10	10	17
0900	3:00	20	20	15	17	20	12	12	17
1000	4:00	20	17	15	20	20	15	15	20
1100	5:00	17	15	10	10	20	15	15	20
1200	6:00	15	15	10	10	20	15	15	30
1300	7:00	15	12	10	10	30	17	17	17
1400	8:00	15	12	10	10	30	17	17	17
1500	9:00	15	10	10	10	30	17	17	17
1600	10:00	17	10	10	10	20	17	17	20
1700	11:00	20	10	10	10	15	15	17	20
1800	12:00	20	10	10	10	12	10	17	30
1900	1:00	20	10	10	10	10	10	12	15
2000	2:00	20	10	10	10	10	10	10	15
2100	3:00	17	10	10	10	10	10	10	12
2200	4:00	15	15	12	10	10	10	10	10
2300	5:00	15	15	12	10	10	10	10	10

EASTERN USA

GMT	EDT	Directional Indicators							
		N	NE	E	SE	S	SW	W	NW
0000	8:00	15	17	15	10	10	10	10	10
0100	9:00	15	20	15	10	12	10	10	10
0200	10:00	17	20	15	10	12	10	10	10
0300	11:00	17	20	17	10	15	10	10	10
0400	12:00	20	30	17	12	20	10	10	10
0500	1:00	20	20	17	15	20	10	10	10
0600	2:00	20	20	15	15	20	10	10	20
0700	3:00	20	30	15	15	20	12	12	20
0800	4:00	15	17	17	15	20	15	15	20
0900	5:00	15	15	15	17	20	15	15	20
1000	6:00	15	15	10	10	20	15	15	15
1100	7:00	12	12	10	10	15	15	15	17
1200	8:00	10	12	10	10	15	15	15	17
1300	9:00	10	12	10	10	30	15	15	17
1400	10:00	12	10	10	10	30	15	15	17
1500	11:00	15	10	10	10	17	17	17	20
1600	12:00	15	10	10	10	15	17	17	20
1700	1:00	17	10	10	10	12	15	17	20
1800	2:00	20	12	10	10	12	10	17	20
1900	3:00	20	12	10	10	10	10	10	15
2000	4:00	20	12	10	10	10	10	10	15
2100	5:00	30	15	10	10	10	10	10	12
2200	6:00	17	15	12	10	10	10	10	10
2300	7:00	15	17	12	10	10	10	10	10

**ORDER
TOLL-FREE
1-800-821-7323**

**Dependable Service
At The Right Price . . . Everytime**

MasterCard—VISA—Discover

Missouri Radio Center

KENWOOD



TS-940 "DX-CELLENCE"

- All Band, All Mode Transceiver
- Direct Keyboard Entry
- Engineered for the DX-Minded and Contesting Ham
- Its Got It All!

YAESU



FT-767GX HF/VHF/UHF BASE STATION

- Add Optional 6m, 2m & 70cm Modules
- Dual VFO's
- Full CW Break-in
- Lots More Features

ICOM **NEW!**



IC-765 NEW HF TRANSCEIVER

- Built-in Automatic Antenna Tuner and Power Supply
- 99 Memories • 100 W Output
- 160-10M/General Coverage Receiver
- Band Stacking Registers

uniden



HR-2600

- Mobile 10 Meter Transceiver
- SSB/AM/FM/CW
- 25 Watts PEP
- New FM Offsets & PL

KENWOOD



TS-140S AFFORDABLE DX-ing!

- HF Transceiver With General Coverage Receiver
- All HF Amateur Bands
- 100 W Output
- Compact, Lots of Features

YAESU



FT-736R VHF-UHF BASE STATION

- SSB, CW, FM on 2 Meters and 70 cm
- Optional 50 MHz, 220 MHz or 1.2 GHz
- 25 Watts Output on 2 Meters, 220 and 70 cm
- 10 Watts Output on 6 Meters and 1.2 GHz • 100 Memories

ICOM **NEW!**



- USB/LSB/CW, AM Receive
- Optional Module for AM Transmit and FM TX/RX
- 160-10M Operation • 100 W Output
- Receive 30 kHz to 33 MHz
- 26 Memories with Band Stacking Registers

ASA CP-100



Complete Terminal Unit for Morse, Baudot, ASCII, AMTOR

**NOW 1/2 PRICE
CLOSEOUT SPECIAL
ONLY \$169. DELIVERED**
Software Available
Call Now—Don't Delay

KENWOOD **NEW!**



TM-231A

2 METER FM MOBILE

- 50 Watts Output
- 20 Multi-Function Memories
- Selectable CTCSS Tone Built-in
- Operate 4 Mobile Rigs with Optional IF-20 Interface and RC-20 Controller

Kantronics



KT-Series Mono-Band Radios

10-15-20-30-40-80M MODELS

SAVE BIG \$\$

Best Price and Complete Selection
Call Today!

ICOM

IC-2GAT IC-4GAT

2 Meter & 440 Handhelds

- IC-2GAT
RX 138-174 MHz
TX 140-150 MHz
7 Watts
- IC-4GAT
440-450 MHz
6 Watts



ASTRON



- RS7A . . . \$51
- RS12A . . . \$75
- RS20A . . . \$92
- RS20M . . . \$112
- VS20M . . . \$129
- RS35A . . . \$149
- RS35M . . . \$167
- VS35M . . . \$179
- RS50A . . . \$209
- RM50M . . . \$235
- RM50M . . . \$259
- VS50M . . . \$245

KENWOOD

SALE! TH-25AT POCKET-SIZED AND POWERFUL

- Frequency Coverage: 141-163 MHz (Rx), 144-148 MHz (Tx)
- Front Panel DTMF Pad
- 5 Watts Output
- 14 Memories
- TH-45AT Available for 440 MHz

ALINCO SUPER SALE

ALD-24T 2m/70cm Dual Band Mobile



\$449.00 Delivered
25W, 21 Memories, Dual VFO's
At an Unbeatable Price!

ICOM

IC-32AT SUPER DUALBAND FM HANDHELD

- 5 Watts on Both Bands
- Receive 138-174 MHz
440-450 MHz
- Stores Standard and Odd Offsets



MFJ SALE MFJ

LARGEST STOCK OF ALL
YOUR MFJ FAVORITE
ACCESSORIES
CALL TODAY FOR
BEST PRICE



Extra Savings on the MFJ-1278
Multi-Mode Data Controller

102 N.W. Business Park Lane Kansas City, MO 64150
Send SASE For Used List

Call Toll Free—9am - 6pm Mon.-Fri. 9am - 2pm Sat.
In Missouri Call—816-741-8118

MOST ORDERS SHIPPED SAME DAY

• DAIWA • HUSTLER

HYGAIN • ICOM •

KANTRONICS • KENWOOD • LARSEN • MFJ • MIRROR/KLM • NYE VIKING • RF CONCEPTS • UNIDEN • YAESU

OPTOELECTRONICS

STOP LOOKING! THE FREQUENCY COUNTER YOU NEED IS HERE NOW!

Take a good look at the model 2210 hand held that does it all. Frequency Range is from 10 Hz to over 2.2 GHz covering audio through microwave. Literally DC to day light with extraordinary sensitivity and accuracy. The 2210 is now in demand by technicians, engineers, law enforcement officers, private investigators, two-way radio operators, scanner hobbyists, and amateur radio operators. Call us today to order yours.

\$199



SENSITIVITY

1 KHz	< 5 mv
100 MHz	< 3 mv
450 MHz	< 3 mv
850 MHz	< 3 mv
1.3 GHz	< 7 mv
2.2 GHz	< 30 mv

(ACTUAL SIZE)

Separate high impedance and 50 ohm amplifier circuits, two ranges, two gate times, dual crystal oscillator design. 8 LED digits, aluminum case, internal Ni-Cad batteries, 1 ppm accuracy, AC-DC portable operation. AC adapter-charger included. Full line of probes, antennas, and carry case is available. We manufacture the 2210 in the U.S. and have over 15 years of service, quality, experience and dedication that you can count on.



OPTOELECTRONICS INC.

5821 N.E. 14th Avenue
Fort Lauderdale, Florida 33334

FLA (305) 771-2050
FAX (305) 771-2052



Orders to U.S. and Canada add 5% to total (\$2 min, \$10 max)
Florida residents add 6% sales tax. COD fee \$3.
Foreign orders add 15%

TWO OF AMERICA'S MOST POPULAR FM STATIONS.



No wonder Yaesu's FT-212R Series and FT-4700RH mobiles are so popular.

Not only are the features unique and plentiful. The operation hassle-free. And the mounting options flexible. But also, each radio now features a built-in PL board. Plus *you* choose the optional mic that best fits your operating and budget needs.

**FT-212R SERIES. MOBILES THAT
DOUBLE AS ANSWERING MACHINES.**

Let the 2-meter FT-212R and 440-MHz FT-712R take messages while you're away (with DVS-1 option)! 45-watt output (35W on 440 MHz). Built-in PL encode/decode. 18 memories. Auto repeater shift. Scanning routines. Offset tuning from any memory channel. Extended receive. Audible command verification. High/low power switch. Oversize amber display. Choice of optional mic. More.

**FT-4700RH. DUAL-BAND PERFORMANCE,
REMOTE-HEAD DESIGN.**

Mount the FT-4700RH almost anywhere — the "brains" on your dash, visor, or door; the "muscle" under your seat. 50 watts on 2 meters, 40 watts on 70 cm. Full crossband duplex. Simultaneous monitoring of each band, complete with independent squelch settings on the main and secondary bands. Built-in PL encode/decode. 9 memories (each

band). Extended receive. Reverse repeater shift. High/low power switch. Patch cord for remote mounting. Bright LCD display. Backlit controls. Choice of optional mic. More.

Want more information? Call **(800) 999-2070** toll-free. Or ask your dealer about Yaesu's FT-212R Series and FT-4700RH mobiles today. Two of America's favorites.

Choose your
optional mic:
MH-15 CS DTMF
mic, or MH-15
DS DTMF auto-
dialer mic



YAESU USA 17210 Edwards Road, Cerritos, CA 90701
(213) 404-2700. **REPAIR SERVICE:** (213) 404-4884.
PARTS: (213) 404-4847.



YAESU

KENWOOD

...pacesetter in Amateur Radio

All New
Compact HF

“DX-citing!”

TS-440S Compact high performance HF transceiver with general coverage receiver

Kenwood's advanced digital know-how brings Amateurs world-wide "big-rig" performance in a compact package. We call it "Digital DX-citement"—that special feeling you get every time you turn the power on!

- Covers All Amateur bands
General coverage receiver tunes from 100 kHz–30 MHz. Easily modified for HF MARS operation.
- Direct keyboard entry of frequency
- All modes built-in
USB, LSB, CW, AM, FM, and AFSK. Mode selection is verified in Morse Code.
- VS-1 voice synthesizer (optional)

- Superior receiver dynamic range
Kenwood DynaMix™ high sensitivity direct mixing system ensures true 102 dB receiver dynamic range. (500Hz bandwidth on 20m)
- 100% duty cycle transmitter
Super efficient cooling permits continuous key-down for periods exceeding one hour. RF input power is rated at 200 W PEP on SSB, 200 W DC on CW, AFSK, FM, and 110 W DC AM. (The PS-50 power supply is needed for continuous duty.)
- Built-in automatic antenna tuner (optional). Covers 80–10 meters.
- 5 IF filter functions
- VOX, full or semi break-in CW

- Dual SSB IF filtering
A built-in SSB filter is standard. When an optional SSB filter (YK-88S or YK-88SN) is installed, **dual** filtering is provided.
- AMTOR compatible
- Adjustable dial torque
- 100 memory channels
Frequency and mode may be stored in 10 groups of 10 channels each. Split frequencies may be stored in 10 channels for repeater operation.
- TU-8 CTCSS unit (optional)
- Superb interference reduction
IF shift, tuneable notch filter, noise blanker, all-mode squelch, RF attenuator, RIT/XIT, and optional filters fight QRM.
- MC-43S UP/DOWN mic. included
- Computer Interface port



Optional accessories:

- AT-440 internal auto. antenna tuner (80 m – 10 m)
- AT-250 external auto. tuner (160 – 10 m)
- AT-130 compact mobile antenna tuner (160 m –

88SN 2.4 kHz/1.8 kHz SSB filters • MC-60A/80/85 desk microphones • MC-55 (8P) mobile microphone • HS-4/5/6/7 headphones • SP-41/50/50

**Kenwood
takes you from
HF to OSCAR!**



- 10 m) • IF-232C/IC-10 level translator and modem IC kit • PS-50 heavy duty power supply • PS-430/PS-3D DC power supply • SP-430 external speaker • MB-430 mobile mounting bracket • YK-88C/88CN 500 Hz/270 Hz CW filters • YK-88S-

- mobile speakers • MA-5/VP-1HF 5 band mobile helical antenna and bumper mount • TL-922A 2 kw PEP linear amplifier • SM-220 station monitor (no pan display) • VS-1 voice synthesizer • TU-8 CTCSS tone unit • PG-2C extra DC cable.

Complete service manuals are available for all Kenwood transceivers and most accessories. Specifications and prices are subject to change without notice or obligation.

KENWOOD

KENWOOD U.S.A. CORPORATION
COMMUNICATIONS & TEST EQUIPMENT GROUP
P.O. BOX 22745, 2201 E. Dominguez Street
Long Beach, CA 90801-5745
KENWOOD ELECTRONICS CANADA INC.
P.O. BOX 1075, 959 Gana Court
Mississauga, Ontario, Canada L4T 4C2